



MARIA TERESA
ATELIER

MASIERO



MARIA TERESA
ATELIER

MASIERO



MARIA TERESA

La spettacolare magnificenza degli antichi saloni nobiliari di Venezia vive attraverso la collezione Maria Teresa.

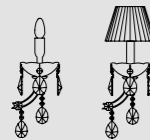
La classicità più preziosa mantiene l'iconica estetica, trasformandone la personalità attraverso il fascino creativo delle diverse tipologie di effetto luminoso ottenuto con i sistemi illuminotecnici avanzati.

The Maria Teresa collection brings to life the spectacular magnificence of the rooms in ancient Venetian stately homes.

The precious classical style maintains its original iconic look, but adopts a new personality thanks to the fascinating creativity of a varied range of lighting effects achieved by the latest control systems.



MT_TRADITIONAL

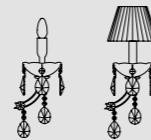


- **Telaio in metallo** con finitura galvanica in colore cromo o oro
- **Braccia** ricoperte in vetro trasparente
- **Bobeches** in vetro trasparente
- **Pendagli** in colore trasparente nelle varianti Half Cut Glass, Cut Crystal e Swarovski
- **Illuminazione** tradizionale con portalamпада attacco E14
- **Apparecchio** dimmerabile a taglio di fase
- **Paralumi** inclusi solo se presenti nella foto. Forma, tessuto e colore come nella foto.

- **Metal frame** in galvanic gold or chrome colour finish
- Transparent **glass arms** coverage
- **Arm's cups** in transparent glass
- **Pendants** in transparent colour in the variations, Half Cut Glass, Cut Crystal, Swarovski
- **Lighting** with bulbs with E14 lamp holder
- Triac dimmable **device**
- **Lampshades** included only when in the picture of the catalogue. Shape, fabric and colour as in the picture.



CG_COLOURED GLASS



- **Telaio in metallo** verniciato nella palette colori prestabilita
- **Braccia** ricoperte in vetro colorato nella palette colori prestabilita
- **Bobeches** in vetro colorato nella palette colori prestabilita
- **Pendagli** disponibili solo in vetro verniciato nella variante cromatica scelta
- **Illuminazione** tradizionale con portalamпада attacco E14
- **Apparecchio** dimmerabile a taglio di fase
- **Paralumi** inclusi solo se presenti nella foto. Forma, tessuto e colore come nella foto.

- **Metal frame** in powder-coated finish in the pre-established colour palette
- Painted **glass arms** coverage in the pre-established colour palette
- **Arm's cups** in painted glass in the pre-established colour palette
- **Glass pendants** (Half Cut Glass) painted in the pre-established colour variations
- **Lighting** with bulbs with E14 lamp holder
- Triac dimmable **device**
- **Lampshades** included only when in the picture of the catalogue. Shape, fabric and colour as in the picture.



DW_DYNAMIC WHITE



- **Telaio in metallo** con finitura galvanica in colore cromo o oro
- **Braccia** ricoperte in vetro trasparente
- **Bobeches** in vetro trasparente
- **Pendagli** in colore trasparente nelle varianti Half Cut Glass, Cut Crystal e Swarovski
- **Illuminazione** con sorgenti a Led integrato con tecnologia brevettata nella versione Bianco Dinamico DW
- **Luce bianca** compresa tra 2700K e 6500K
- **Apparecchio** gestito con protocollo DMX
- **Disponibile su richiesta** Telecomando

- **Metal frame** in galvanic finish in gold or chrome colour
- Transparent **glass arms** coverage
- **Arm's cups** in transparent glass
- **Pendants** in transparent colour in the variations, Half Cut Glass, Cut Crystal, Swarovski
- **Lighting** with integrated LED sources (technology developed by Masiero) in the White Dynamic DW version
- **White light** between 2700K and 6500K
- **Device** managed with DMX protocol
- **Available on request** Radio Control



RW_RGB-W



- **Telaio in metallo** con finitura galvanica in colore cromo o oro
- **Braccia** ricoperte in vetro trasparente
- **Bobeches** in vetro trasparente
- **Pendagli** in colore trasparente nelle varianti Half Cut Glass, Cut Crystal e Swarovski
- **Illuminazione** con sorgenti a Led integrato con tecnologia brevettata nella versione RGB-W
- **Luce bianca** a 3000K
- **Apparecchio** gestito con protocollo DMX
- **Disponibile su richiesta** APP Masiero Smart Light o Telecomando

- **Metal frame** in galvanic finish in chrome colour
- Transparent **glass arms** coverage
- **Arm's cups** in transparent glass
- **Pendants** in transparent colour in the variations, Half Cut Glass, Cut Crystal, Swarovski
- **Lighting** with integrated LED sources (technology developed by Masiero) in the RGB + White version
- **White light** at 3000K
- **Device** managed with DMX protocol
- **Available on request** APP Masiero Smart Light or Radio Control



DYNAMIC WHITE CONTROL

6000K

2700K

Il sistema **DYNAMIC WHITE Control** è dotato di una centralina* di controllo che consente di gestire tutte le funzioni in base alle esigenze dell'utilizzatore.

The control unit in the **Dynamic White Control** system allows all functions to be managed according to the user's needs.*



RGB-W CONTROL

RGB-W

Il sistema **RGB-W Control** è dotato di una centralina* di controllo che consente di gestire tutte le funzioni in base alle esigenze dell'utilizzatore.

The control unit in the **RGB-W Control** system allows all functions to be managed according to the user's needs.*

*Centralina non inclusa
Control unit not included

Ogni dispositivo **Maria Teresa** può essere integrato nei sistemi domotici di qualsiasi abitazione gestiti con **protocollo DMX**.

*Each **Maria Teresa** device can be integrated into any home automation system managed with the DMX protocol.*

Su richiesta è possibile fornire il dispositivo di uno di questi sistemi di gestione:

On request, the device can be provided with one of the following control systems:

- **RADIOCOMANDO:**

Ogni singolo dispositivo può essere controllato con un radiocomando.

Su richiesta, un unico radiocomando può gestire più dispositivi diversi.

- **RADIO CONTROL:**

Each individual device can be controlled via a radio remote control.

On request, a single remote control can manage several different devices.

- **APP SU SMARTPHONE O TABLET:**

MASIERO ha sviluppato una **APP** disponibile per **sistemi IOS e Android** che, con un'interfaccia semplice ed intuitiva, permette di gestire un numero infinito di dispositivi, contemporaneamente oppure singolarmente.

- **APP ON YOUR SMARTPHONE OR TABLET:**

*MASIERO has developed an **APP** for **IOS** and **Android** systems with a simple, intuitive interface to allow an infinite number of devices to be controlled together or individually.*

RADIO CONNECTION WITH
REMOTE CONTROL

*(Per versione DW e RGB-W)
(For DW and RGB-W version)*



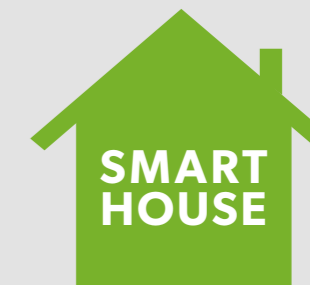
WI-FI CONNECTION WITH
"MASIERO SMART LIGHT" APP

*(Solo per versione RGB-W)
(Only for RGB-W version)*



DMX CONNECTION
WITH DOMOTIC NET

*(Per versione DW e RGB-W)
(For DW and RGB-W version)*



MT TRADITIONAL

Il modello Maria Teresa nella versione classica ricrea la stessa atmosfera degli storici palazzi veneziani. Telaio in metallo disponibile in finitura oro lucido e cromo lucido.

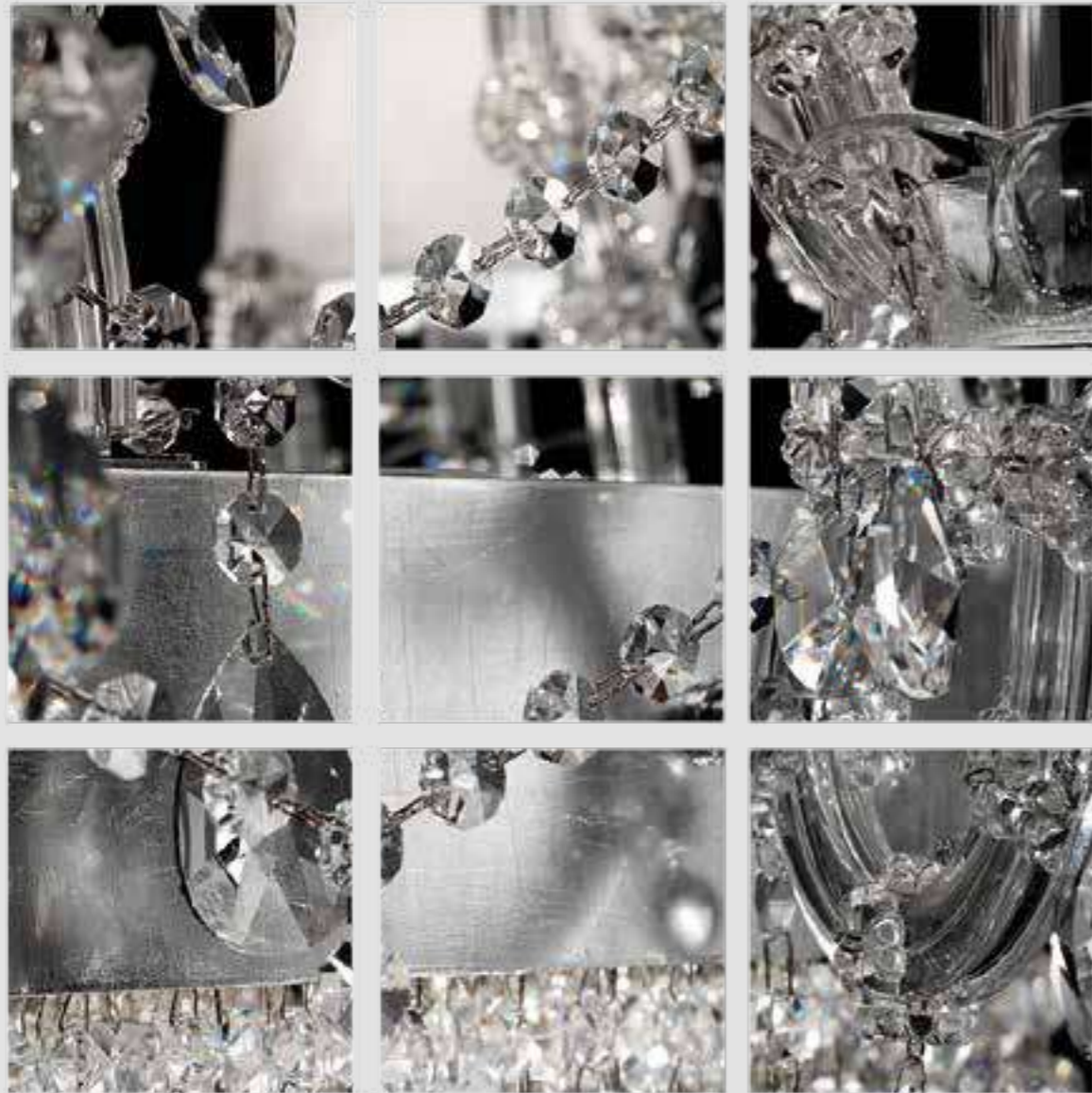
Braccia ricoperte in vetro trasparente e pendagli disponibili in vetro, Cut Crystal o in Swarovski.

The classic version of the Maria Teresa model recreates the atmosphere of historic Venetian stately homes.

The metal frame is available in polished gold or polished chrome.

The arms are covered in clear glass and the pendants are available in glass, cut crystal or Swarovski glass.





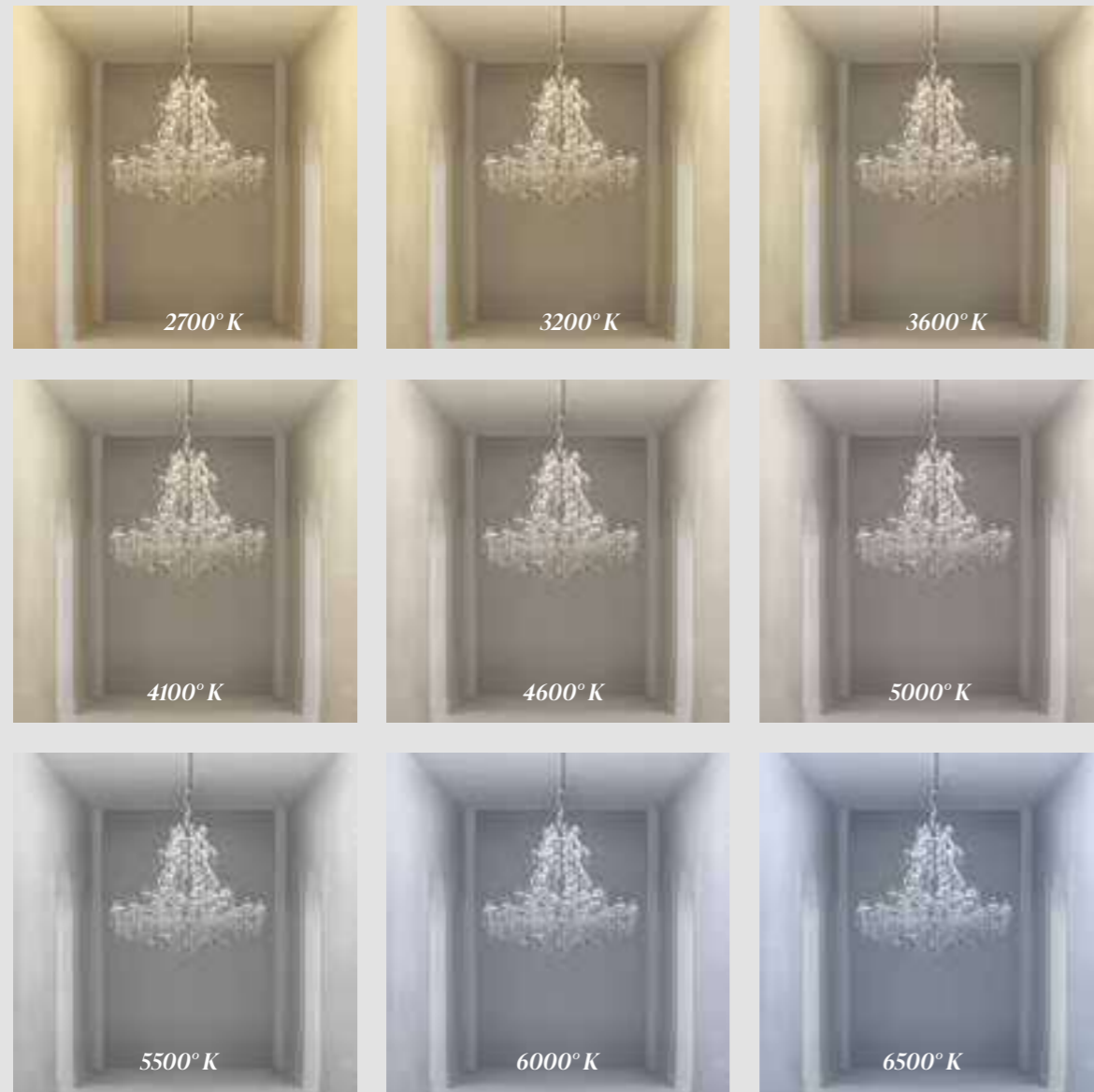
DW DYNAMIC WHITE

Il modello Maria Teresa dotato del sistema di illuminazione brevettato LED Bianco Dinamico, permette di personalizzare la temperatura della luce, andando a ricreare il ciclo naturale del sole e scandendo così il ritmo del ciclo circadiano. La luce bianca può essere regolata con una temperatura tra i 2700K e 6500K. Grazie alla tecnologia LED si è pertanto in grado di assecondare l'esigenza di confort e benessere del corpo umano.

In the Maria Teresa model with patented Dynamic White LED lighting system, light temperature can be customised to recreate the natural cycle of the sun, following the rhythm of the circadian cycle. The white light can be adjusted to a temperature between 2700K and 6500K. The LED technology thus makes it possible to provide the comfort and wellness needed by the human body.



VE 951/24 DW



RW RGB-W

La collezione Maria Teresa realizzata con tecnologia brevettata LED RGB-W consente di trasformare la luce in puro colore, rinnovando completamente la percezione visiva dello spazio, che si riempie di infinite sfumature. Le superfici cambiano aspetto e l'ambiente muta secondo desiderio ed umore. E' possibile ottenere anche luce bianca a 3000K.

The Maria Teresa collection with patented RGB-W LED technology, can transform light into pure colour, filling the space with an infinity of hues for a completely new visual perception. Surfaces alter their appearance and the whole ambience changes mood to reflect your personal preferences. White light at 3000K can also be obtained.





VE 951/24 RW

CG COLOURED GLASS

La collezione Maria Teresa in vetro colorato interpreta un classico senza tempo in chiave contemporanea. Il colore è protagonista assoluto e veste il telaio, le braccia, i paralumi ed i pendagli.

Telaio in metallo verniciato e pendagli in vetro verniciato disponibili in nove colori.

Sistema di illuminazione tradizionale.

The Maria Teresa collection in coloured glass interprets a timeless classic with a contemporary twist.

Colour is the absolute protagonist, adorning the frame, arms, shades and pendants.

The painted metal frame and painted glass pendants are available in a choice of nine colours.

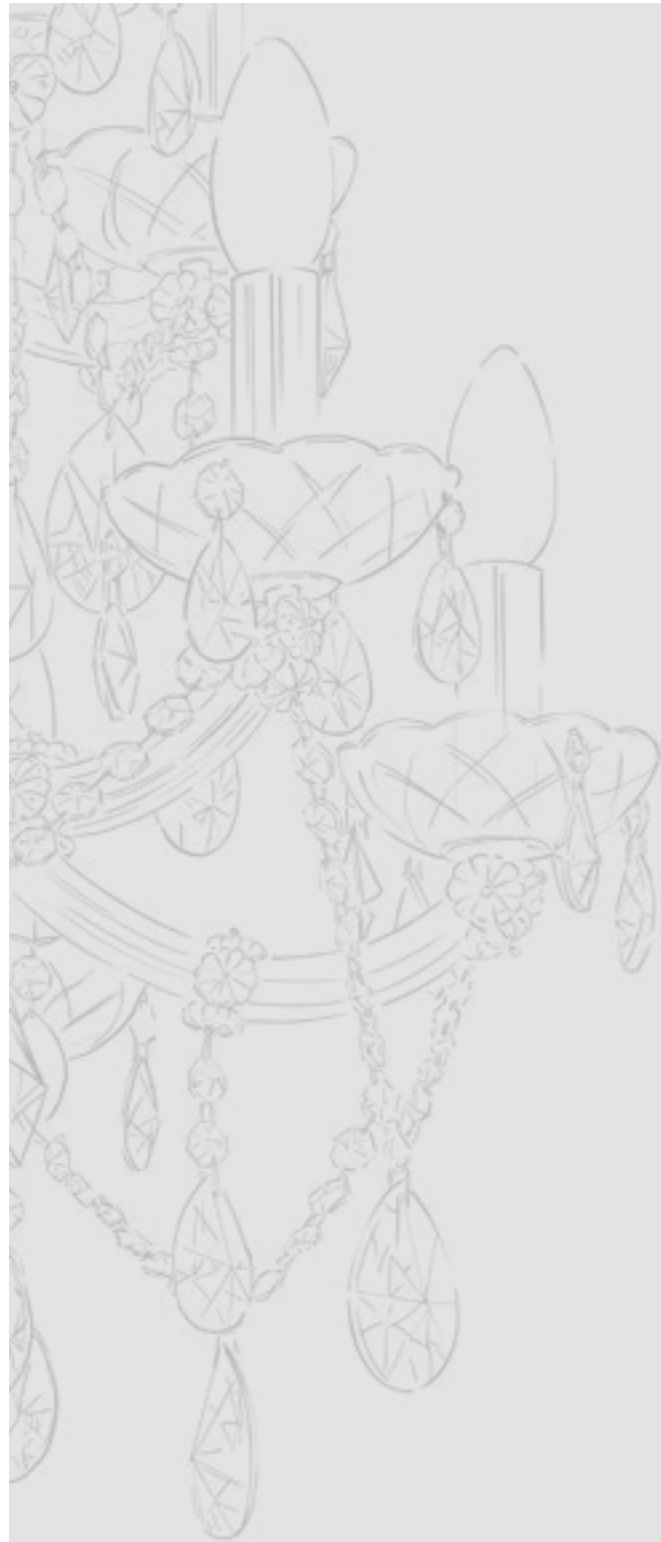
Traditional lighting system.




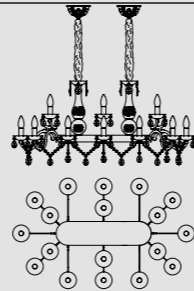
VE 903/56 CG



VE 951/24 CG




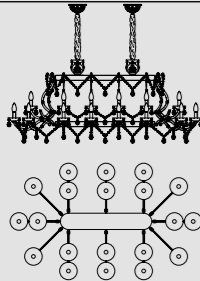
VE 945/18 



L 107 cm / 42.21"
SP 65 cm / 25.59"
H 45 cm / 17.71"
W 25 kg / 55.11 lb


WW 18×E14×40 W max (not included)
USA 18×E12×40 W max (not included)
RW-DW 18×LED source - 72 W tot

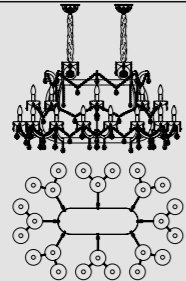
VE 945/20 



L 153 cm / 60.23"
SP 93 cm / 36.61"
H 66 cm / 25.98"
W 34 kg / 74.95 lb


WW 20×E14×40 W max (not included)
USA 20×E12×40 W max (not included)
RW-DW 20×LED - 80 W tot

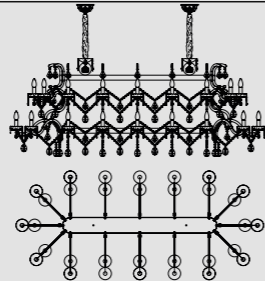
VE 945/24 



L 129 cm / 50.78"
SP 88 cm / 34.64"
H 70 cm / 27.55"
W 45 kg / 99.20 lb

WW 24×E14×40 W max (not included)
USA 24×E12×40 W max (not included)
RW-DW 24×LED - 96 W tot

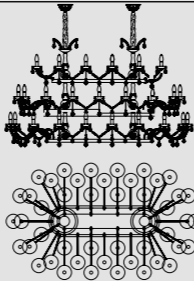
VE 945/32 



L 200 cm / 78.74"
SP 88 cm / 34.64"
H 80 cm / 31.49"
W 57 kg / 125.66 lb

WW 32×E14×40 W max (not included)
USA 32×E12×40 W max (not included)
RW-DW 32×LED - 128 W tot

VE 945/46 



L 192 cm / 75.59"
SP 114 cm / 44.88"
H 110 cm / 43.30"
W 60 kg / 132.27 lb

WW 46×E14×40 W max (not included)
USA 46×E12×40 W max (not included)
RW-DW 46×LED - 184 W tot




VE 945/32

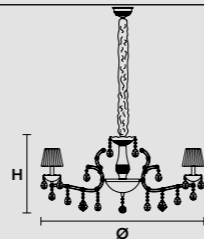


<p>VE 996/15 CE </p>	<p>VE 996/36 CE </p>	<p>VE 996/48 CE </p>
<p>Ø 95 cm / 37.40" H 60 cm / 23.62" W 17 kg / 37.47 lb</p> <p>WW 15×E14×40 W max (not included) USA 15×E12×40 W max (not included)</p> <p>RW-DW 15×LED - source 60 W tot</p>	<p>Ø 165 cm / 64.96" H 95 cm / 37.40" W 48 kg / 105.82 lb</p> <p>WW 36×E14×40 W max (not included) USA 36×E12×40 W max (not included)</p> <p>RW-DW 36×LED - source 144 W tot</p>	<p>Ø 210 cm / 82.67" H 110 cm / 43.30" W 95 kg / 209.43 lb</p> <p>WW 48×E14×40 W max (not included) USA 48×E12×40 W max (not included)</p> <p>RW-DW 48×LED - source 192 W tot</p>

VE 996/36

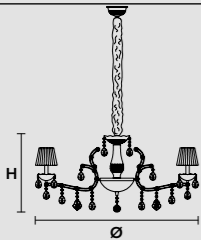


VE 961/8 




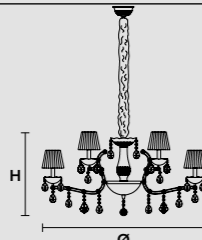
Ø 75 cm / 29.52"
 H 42 cm / 16.53"
 W 11 kg / 24.25 lb
 WW 8×E14×40 W max (not included)
 USA 8×E12×40 W max (not included)
 RW-DW 8×LED source-32 W tot

VE 961/10 




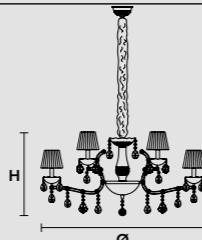
Ø 85 cm / 33.46"
 H 42 cm / 16.53"
 W 17 kg / 37.47 lb
 WW 10×E14×40 W max (not included)
 USA 10×E12×40 W max (not included)
 RW-DW 10×LED source-40 W tot

VE 961/12 




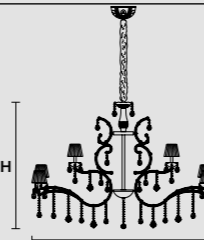
Ø 75 cm / 29.52"
 H 60 cm / 23.62"
 W 16 kg / 35.27 lb
 WW 12×E14×40 W max (not included)
 USA 12×E12×40 W max (not included)
 RW-DW 12×LED source-48 W tot

VE 961/15 



Ø 85 cm / 33.46"
 H 60 cm / 23.62"
 W 22 kg / 48.50 lb
 WW 15×E14×40 W max (not included)
 USA 15×E12×40 W max (not included)
 RW-DW 15×LED source-60 W tot

VE 961/24 




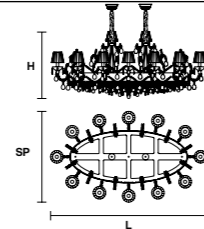
Ø 150 cm / 59.05"
 H 105 cm / 41.33"
 W 40 kg / 88.18 lb
 WW 24×E14×40 W max (not included)
 USA 24×E12×40 W max (not included)
 RW-DW 24×LED source-576 W tot



VE 961/8



VE 921/24 

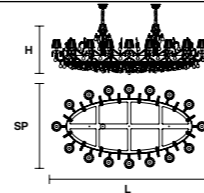


L 150 cm / 59.06"
 SP 85 cm / 33.46"
 H 68 cm / 26.77"
 W 43 kg / 94.79 lb

WW 12×E14×40 W max (not included)
 12×E27×60 W max (not included)
 USA 12×E12×40 W max (not included)
 12×E26×60 W max (not included)

RW-DW 24×LED source -56 W tot

VE 921/32 



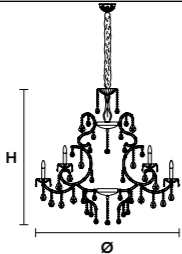
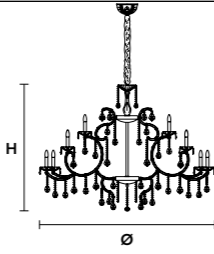
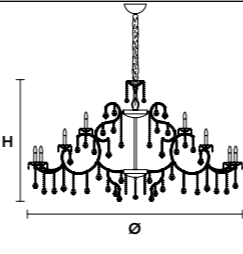
L 200 cm / 78.74"
 SP 110 cm / 43.30"
 H 65 cm / 25.59"
 W 60 kg / 132.27 lb

WW 16×E14×40 W max (not included)
 16×E27×60 W max (not included)
 USA 16×E12×40 W max (not included)
 16×E26×60 W max (not included)

RW-DW 32×LED source -96 W tot

VE 921/ 24

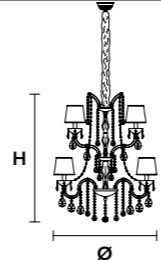


VE 998/18	VE 998/40	VE 998/56
		
Ø 125 cm / 49.21" H 130 cm / 51.18" W 30 kg / 66.13 lb	Ø 170 cm / 66.92" H 120 cm / 47.24" W 60 kg / 132.27 lb	Ø 215 cm / 84.64" H 120 cm / 47.24" W 120 kg / 264.5 lb
WW 18×E14×40 W max (not included) USA 18×E12×40 W max (not included)	WW 40×E14×40 W max (not included) USA 40×E12×40 W max (not included)	WW 56×E14×40 W max (not included) USA 56×E12×40 W max (not included)
RW-DW 18×LED source - 72 W tot	RW-DW 40×LED source - 160 W	RW-DW 56×LED source - 224 W

VE 998/18



VE 992/18 

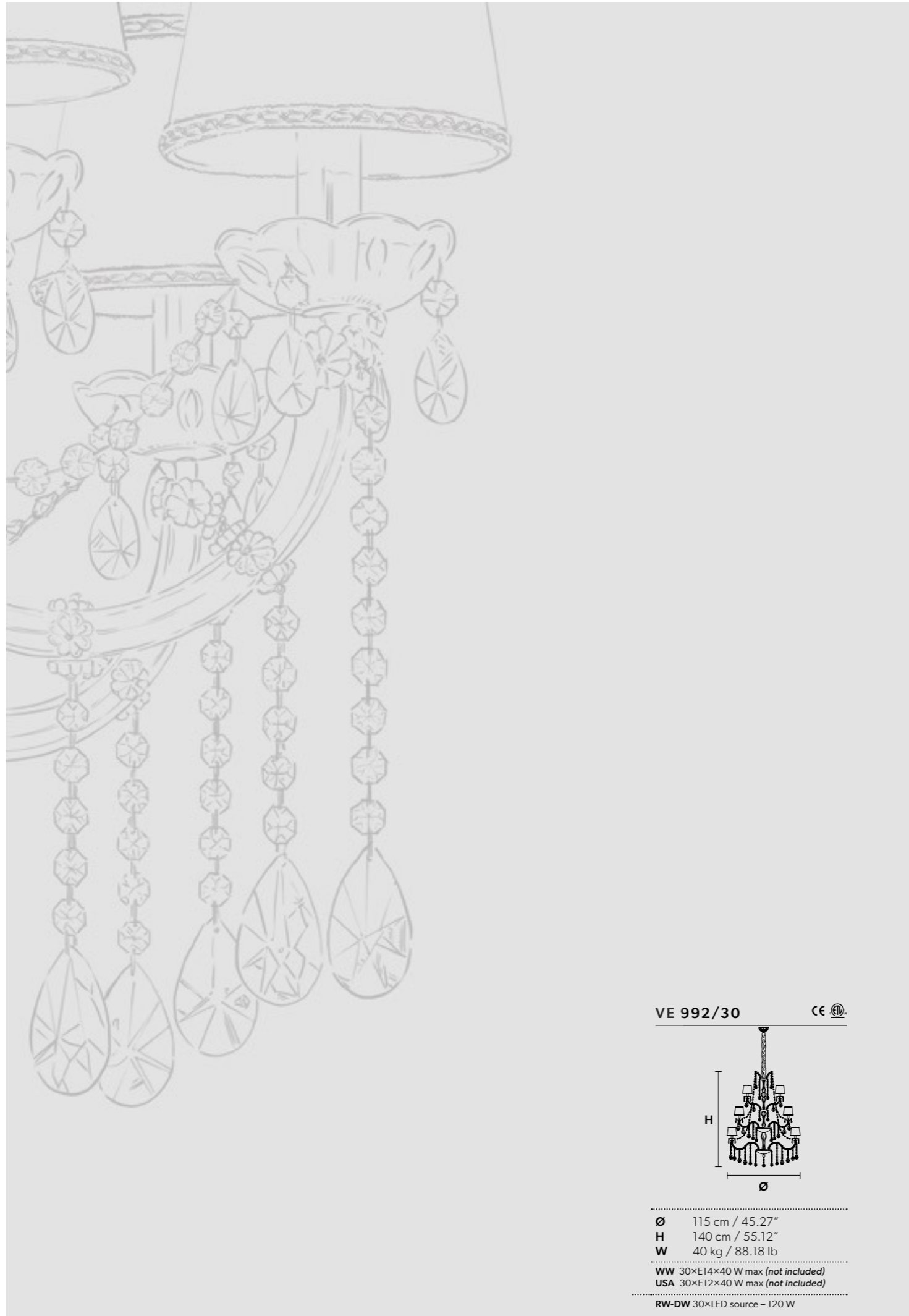


Ø	85 cm / 33.46"
H	100 cm / 39.37"
W	25 kg / 55.11 lb

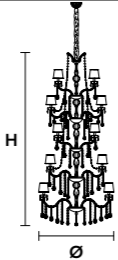
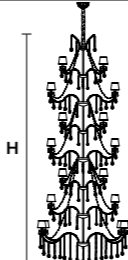
WW 18×E14×40 W max (not included)
 USA 18×E12×40 W max (not included)

RW-DW 18×LED source - 72 W tot

VE 992/18



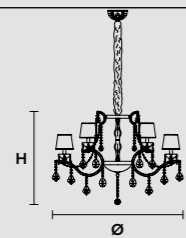


VE 992/48	CE	VE 992/70	CE
			
Ø 120 cm / 47.24"		Ø 150 cm / 59.05"	
H 240 cm / 94.49"		H 380 cm / 149.60"	
W 80 kg / 176.37 lb		W 100 kg / 220.4 lb	
WW 48×E14×40 W max (not included)		WW 70×E14×40 W max (not included)	
USA 48×E12×40 W max (not included)		USA 70×E12×40 W max (not included)	
RW-DW 48×LED source - 72 W tot		RW-DW 70×LED source - 120 W	

VE 992/48



VE 986/15

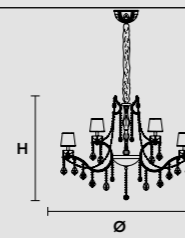


Ø 95 cm / 37.40"
H 70 cm / 27.55"
W 18 kg / 39.68 lb

WW 15×E14×40 W max (not included)
USA 15×E12×40 W max (not included)

RW-DW 15×LED source – 60 W tot

VE 986/18

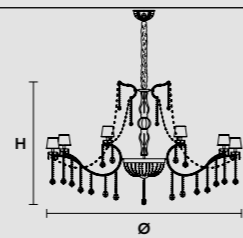


Ø 135 cm / 53.14"
H 90 cm / 35.43"
W 30 kg / 66.13 lb

WW 18×E14×40 W max (not included)
USA 18×E12×40 W max (not included)

RW-DW 18×LED source – 72 W tot

VE 986/39



Ø 190 cm / 74.80"
H 125 cm / 49.21"
W 70 kg / 154.32 lb

WW 39×E14×40 W max (not included)
USA 39×E12×40 W max (not included)

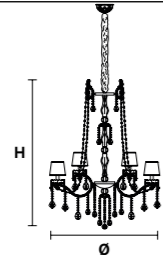
RW-DW 39×LED source – 156 W



VE 986/18



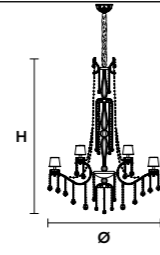
VE 987/15 CE VE 987/18 CE VE 987/39 CE



Ø 95 cm / 37.40"
 H 130 cm / 51.18"
 W 20 kg / 44.09 lb

WW 15×E14×40 W max (not included)
 USA 15×E12×40 W max (not included)

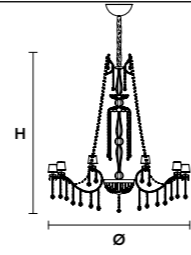
RW-DW 15×LED source - 60 W tot



Ø 140 cm / 55.11"
 H 200 cm / 78.74"
 W 38 kg / 83.77 lb

WW 18×E14×40 W max (not included)
 USA 18×E12×40 W max (not included)

RW-DW 18×LED source - 72 W tot



Ø 190 cm / 74.80"
 H 210 cm / 82.67"
 W 80 kg / 176.37 lb

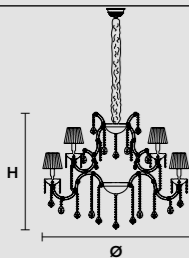
WW 39×E14×40 W max (not included)
 USA 39×E12×40 W max (not included)

RW-DW 39×LED source - 156 W

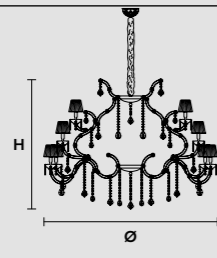
VE 987/18



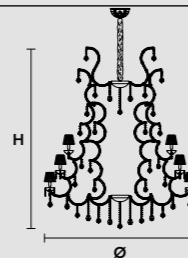
VE 906/15 CE VE 906/32 CE VE 906/42 CE VE 906/49 CE



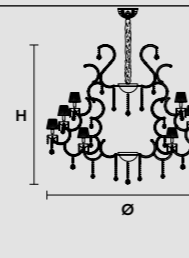
Ø 100 cm / 39.37"
 H 78 cm / 30.37"
 W 25 kg / 55.11 lb
 WW 15×E14×40 W max (not included)
 USA 15×E12×40 W max (not included)
 RW-DW 15×LED source - 60 W tot



Ø 125 cm / 49.21"
 H 90 cm / 35.43"
 W 40 kg / 88.18 lb
 WW 32×E14×40 W max (not included)
 USA 32×E12×40 W max (not included)
 RW-DW 32×LED source - 128 W tot



Ø 150 cm / 59.05"
 H 180 cm / 70.86"
 W 75 kg / 165.34 lb
 WW 42×E14×40 W max (not included)
 USA 42×E12×40 W max (not included)
 RW-DW 42×LED source - 168 W tot



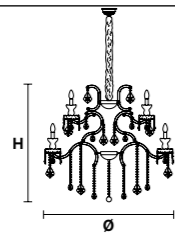
Ø 190 cm / 74.80"
 H 170 cm / 66.92"
 W 90 kg / 198.41 lb
 WW 49×E14×40 W max (not included)
 USA 49×E12×40 W max (not included)
 RW-DW 49×LED source - 196 W tot



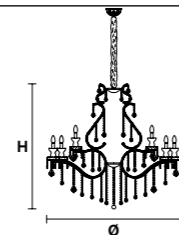
VE 906/49 CG



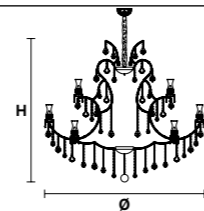
VE 905/15 CE VE 905/24 CE VE 905/56 CE



Ø 90 cm / 35.43"
 H 80 cm / 31.49"
 W 38 kg / 83.77 lb
 WW 15×E14×40 W max (not included)
 USA 15×E12×40 W max (not included)
 RW-DW 15×LED source - 60 W tot



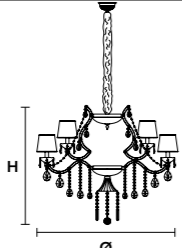
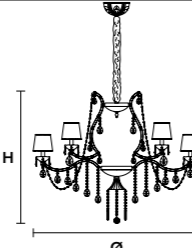
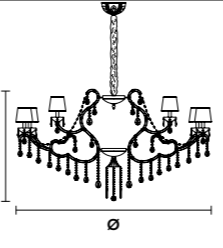
Ø 145 cm / 57.08"
 H 120 cm / 47.24"
 W 60 kg / 132.27 lb
 WW 24×E14×40 W max (not included)
 USA 24×E12×40 W max (not included)
 RW-DW 24×LED source - 96 W tot



Ø 210 cm / 102.40"
 H 195 cm / 118.20"
 W 140 kg / 308.6 lb
 WW 56×E14×40 W max (not included)
 USA 56×E12×40 W max (not included)
 RW-DW 56×LED source - 224 W tot

VE 905/56

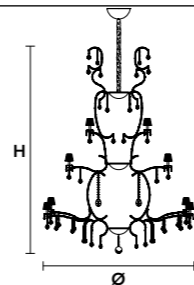


VE 991/15	VE 991/24	VE 991/36
		
<p>Ø 95 cm / 37.40"</p> <p>H 65 cm / 25.59"</p> <p>W 17 kg / 37.47 lb</p> <p>WW 15×E14×40 W max (not included)</p> <p>USA 15×E12×40 W max (not included)</p> <p>RW-DW 15×LED source - 60 W tot</p>	<p>Ø 140 cm / 55.11"</p> <p>H 100 cm / 39.37"</p> <p>W 30 kg / 66.13 lb</p> <p>WW 24×E14×40 W max (not included)</p> <p>USA 24×E12×40 W max (not included)</p> <p>RW-DW 24×LED source - 96 W tot</p>	<p>Ø 165 cm / 64.96"</p> <p>H 95 cm / 37.40"</p> <p>W 50 kg / 110.23 lb</p> <p>WW 36×E14×40 W max (not included)</p> <p>USA 36×E12×40 W max (not included)</p> <p>RW-DW 36×LED source - 224 W tot</p>

VE 991/24




VE 973/70 

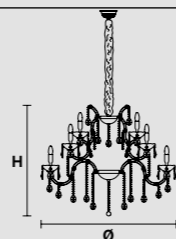


Ø 290 cm / 114.17"
H 300 cm / 118.20"
W 135 kg / 297.6 lb
WW 70×E14×40 W max (not included)
USA 70×E12×40 W max (not included)
RW-DW 70×LED source -280 W tot

VE 973/70 CG




VE 910/25 

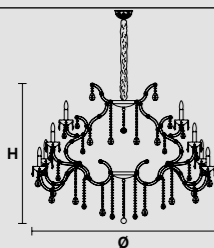


Ø 100 cm / 39.37"
 H 75 cm / 29.52"
 W 26 kg / 57.32 lb

WW 25×E14×40 W max (not included)
 USA 25×E12×40 W max (not included)

RW-DW 25×LED source -100 W tot


VE 910/32 

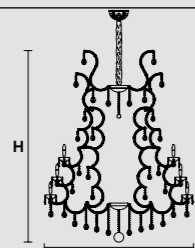


Ø 125 cm / 49.21"
 H 90 cm / 35.43"
 W 40 kg / 88.18 lb

WW 32×E14×40 W max (not included)
 USA 32×E12×40 W max (not included)

RW-DW 32×LED source -128 W tot

VE 910/42 

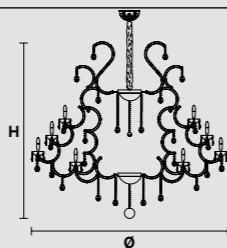


Ø 150 cm / 59.05"
 H 180 cm / 70.87"
 W 70 kg / 154.32 lb

WW 42×E14×40 W max (not included)
 USA 42×E12×40 W max (not included)

RW-DW 42×LED source -168 W tot


VE 910/49 

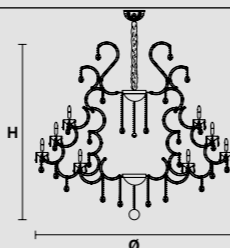


Ø 185 cm / 72.83"
 H 165 cm / 64.96"
 W 85 kg / 187.39 lb

WW 49×E14×40 W max (not included)
 USA 49×E12×40 W max (not included)

RW-DW 49×LED source -196 W tot

VE 910/56 



Ø 185 cm / 72.83"
 H 165 cm / 64.96"
 W 100 kg / 220.5 lb

WW 56×E14×40 W max (not included)
 USA 56×E12×40 W max (not included)

RW-DW 56×LED source -224 W tot




VE 910/56

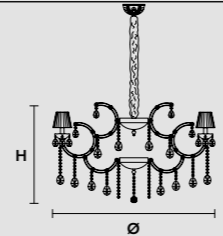


VE 929/24	CE	VE 929/36	CE
<p>Ø 120 cm / 47.24"</p> <p>H 120 cm / 47.24"</p> <p>W 57 kg / 125.66 lb</p> <p>WW 24×E14×40 W max (not included)</p> <p>USA 24×E12×40 W max (not included)</p> <p>RW-DW 24×LED source -96 W tot</p>		<p>Ø 165 cm / 64.96"</p> <p>H 160 cm / 62.99"</p> <p>W 90 kg / 198.41 lb</p> <p>WW 36×E14×40 W max (not included)</p> <p>USA 36×E12×40 W max (not included)</p> <p>RW-DW 36×LED source -144 W tot</p>	

VE 929/24



VE 981/12 



Ø 106 cm / 41.73"
 H 70 cm / 27.55"
 W 20 kg / 44.09 lb


WW 12×E14×40 W max (not included)
 USA 12×E12×40 W max (not included)

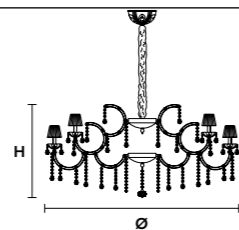
RW-DW 12×LED source - 48 W tot



VE 981/12




VE 981/24 

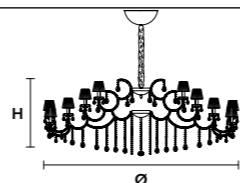


Ø 140 cm / 55.11"
H 70 cm / 27.55"
W 40 kg / 88.18 lb

WW 24×E14×40 W max (not included)
USA 24×E12×40 W max (not included)

RW-DW 24×LED source -96 W tot

VE 981/60 

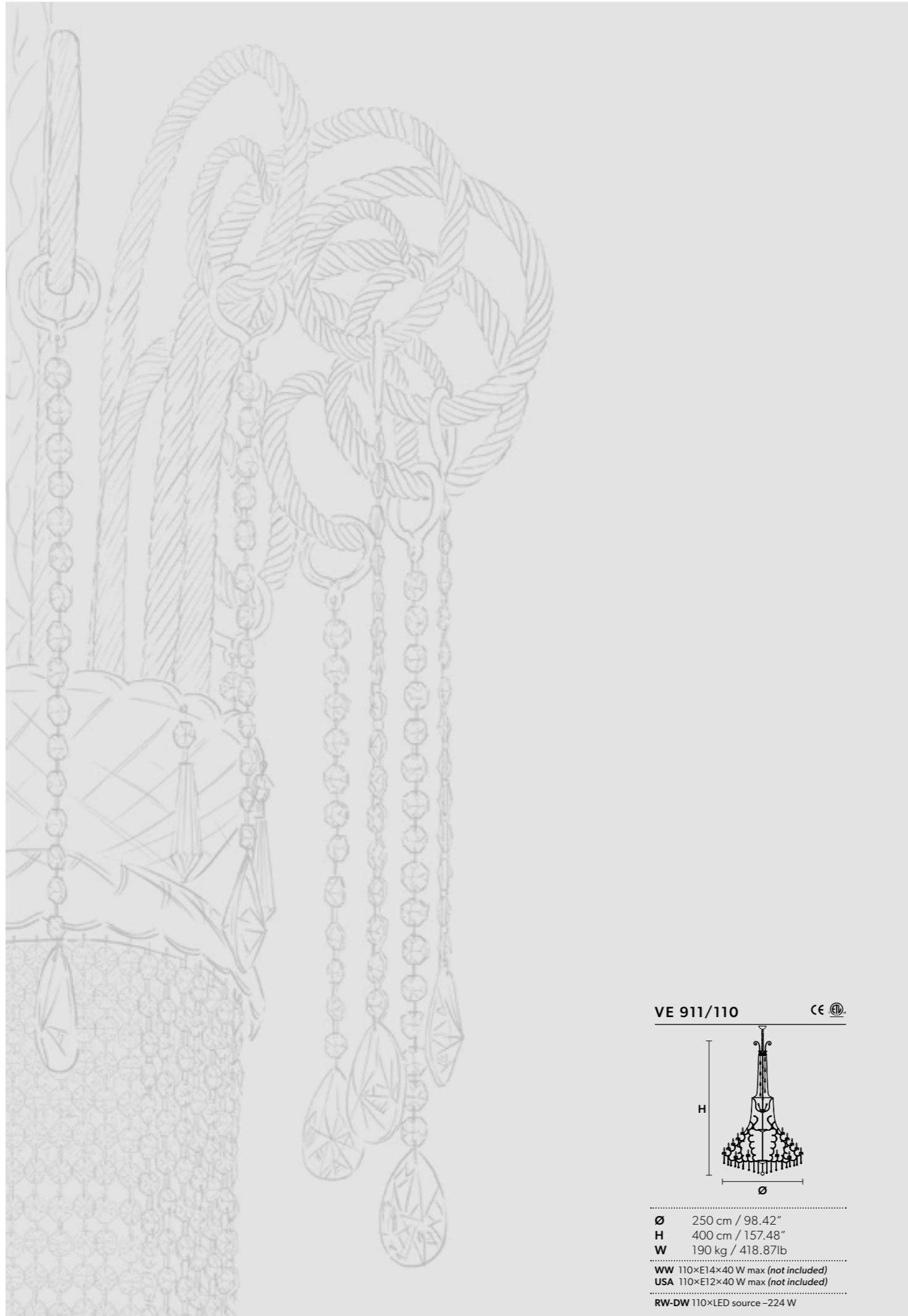


Ø 220 cm / 86.61"
H 75 cm / 29.52"
W 72 kg / 158.73 lb

WW 60×E14×40 W max (not included)
USA 60×E12×40 W max (not included)

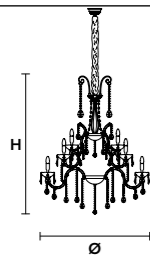
RW-DW 60×LED source - 240 W

VE 981/24 RW

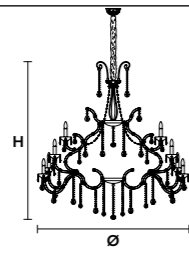




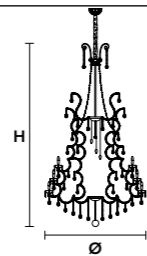
VE 911/25 CE VE 911/32 CE VE 911/45 CE VE 911/56 CE



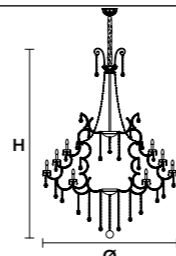
Ø 100 cm / 39.37"
 H 160 cm / 62.99"
 W 30 kg / 66.13 lb
 WW 25×E14×40 W max (not included)
 USA 25×E12×40 W max (not included)
 RW-DW 25×LED source -60 W tot



Ø 125 cm / 49.21"
 H 170 cm / 66.92"
 W 45 kg / 99.20 lb
 WW 32×E14×40 W max (not included)
 USA 32×E12×40 W max (not included)
 RW-DW 32×LED source -128 W tot



Ø 150 cm / 59.05"
 H 270 cm / 106.29"
 W 80 kg / 176.36 lb
 WW 45×E14×40 W max (not included)
 USA 45×E12×40 W max (not included)
 RW-DW 45×LED source -168 W tot

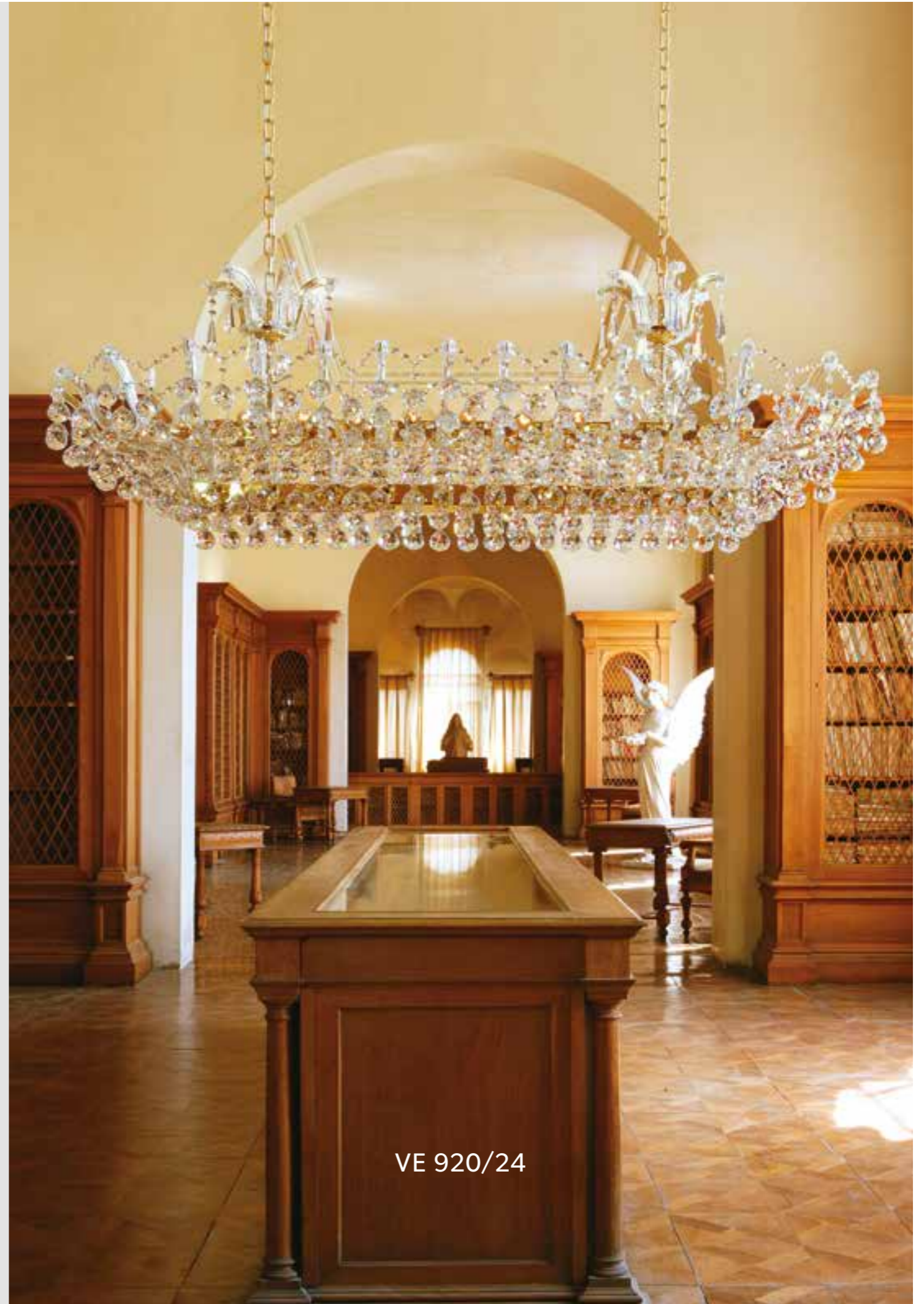


Ø 185 cm / 72.83"
 H 240 cm / 94.48"
 W 110 kg / 242.5 lb
 WW 56×E14×40 W max (not included)
 USA 56×E12×40 W max (not included)
 RW-DW 56×LED source -196 W tot

VE 911/56



VE 920/14	VE 920/24	VE 920/30
L 90 cm / 35.43"	L 160 cm / 62.99"	L 200 cm / 78.74"
SP 45 cm / 17.72"	SP 70 cm / 27.55"	SP 70 cm / 27.55"
H 50 cm / 19.69"	H 60 cm / 23.62"	H 60 cm / 23.62"
W 48 kg / 105.82 lb	W 77.5 kg / 170.8 lb	W 100 kg / 220.4 lb
WW 14×E14×40 W max (not included) USA 14×E12×40 W max (not included)	WW 24×E14×40 W max (not included) USA 24×E12×40 W max (not included)	WW 30×E14×40 W max (not included) USA 30×E12×40 W max (not included)
RW-DW 14×LED source -56 W tot	RW-DW 24×LED source -96 W tot	RW-DW 30×LED source -120 W tot



VE 920/24

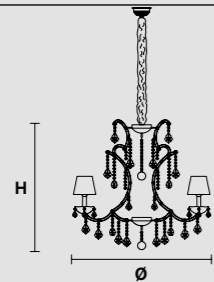


VE 980/12	VE 980/24	VE 980/60
<p>Ø 106 cm / 41.73"</p> <p>H 70 cm / 27.55"</p> <p>W 16 kg / 35.27 lb</p> <p>WW 12×E14×40 W max (not included)</p> <p>USA 12×E12×40 W max (not included)</p> <p>RW-DW 12×LED source - 48 W tot</p>	<p>Ø 140 cm / 55.11"</p> <p>H 70 cm / 27.55"</p> <p>W 37 kg / 81.57 lb</p> <p>WW 24×E14×40 W max (not included)</p> <p>USA 24×E12×40 W max (not included)</p> <p>RW-DW 24×LED source - 96 W tot</p>	<p>Ø 220 cm / 86.61"</p> <p>H 75 cm / 29.52"</p> <p>W 67 kg / 147.70 lb</p> <p>WW 60×E14×40 W max (not included)</p> <p>USA 60×E12×40 W max (not included)</p> <p>RW-DW 60×LED source - 240 W</p>

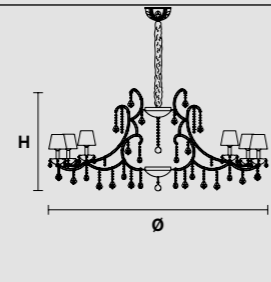
VE 980/24



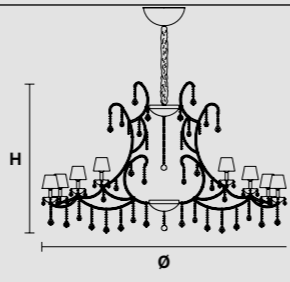
VE 915/12 CE VE 915/36 CE VE 915/48 CE



Ø 95 cm / 37.40"
 H 82 cm / 32.28"
 W 25 kg / 55.11 lb
 WW 12×E14×40 W max (not included)
 USA 12×E12×40 W max (not included)
 RW-DW 12×LED source – 48 W tot



Ø 170 cm / 66.92"
 H 90 cm / 35.43"
 W 60 kg / 132.27 lb
 WW 36×E14×40 W max (not included)
 USA 36×E12×40 W max (not included)
 RW-DW 36×LED source – 144 W



Ø 205 cm / 80.70"
 H 140 cm / 55.11"
 W 95 kg / 209.43 lb
 WW 48×E14×40 W max (not included)
 USA 48×E12×40 W max (not included)
 RW-DW 48×LED source – 192

VE 915/12

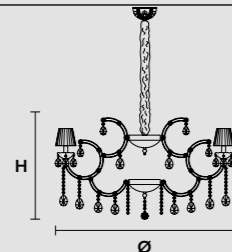


<p>VE 988/32 </p>	<p>VE 988/48 </p>
<p>Ø 130 cm / 51.18" H 90 cm / 35.43" W 30 kg / 66.13 lb</p> <p>WW 32×E14×40 W max (not included) USA 32×E12×40 W max (not included) RW-DW 32×LED source -128 W tot</p>	<p>Ø 130 cm / 51.18" H 90 cm / 35.43" W 51 kg / 112.43 lb</p> <p>WW 48×E14×40 W max (not included) USA 48×E12×40 W max (not included) RW-DW 48×LED source -192 W tot</p>

VE 988/48



VE 984/12

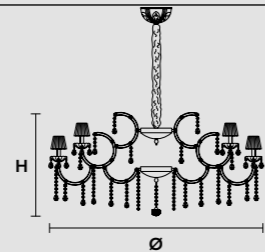


Ø 106 cm / 41.73"
H 70 cm / 27.55"
W 18 kg / 39.68 lb

WW 12×E14×40 W max (not included)
USA 12×E12×40 W max (not included)

RW-DW 12×LED source - 48 W tot

VE 984/24

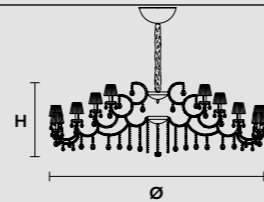


Ø 140 cm / 55.11"
H 70 cm / 27.55"
W 37 kg / 81.57 lb

WW 24×E14×40 W max (not included)
USA 24×E12×40 W max (not included)

RW-DW 24×LED source - 96 W tot

VE 984/60

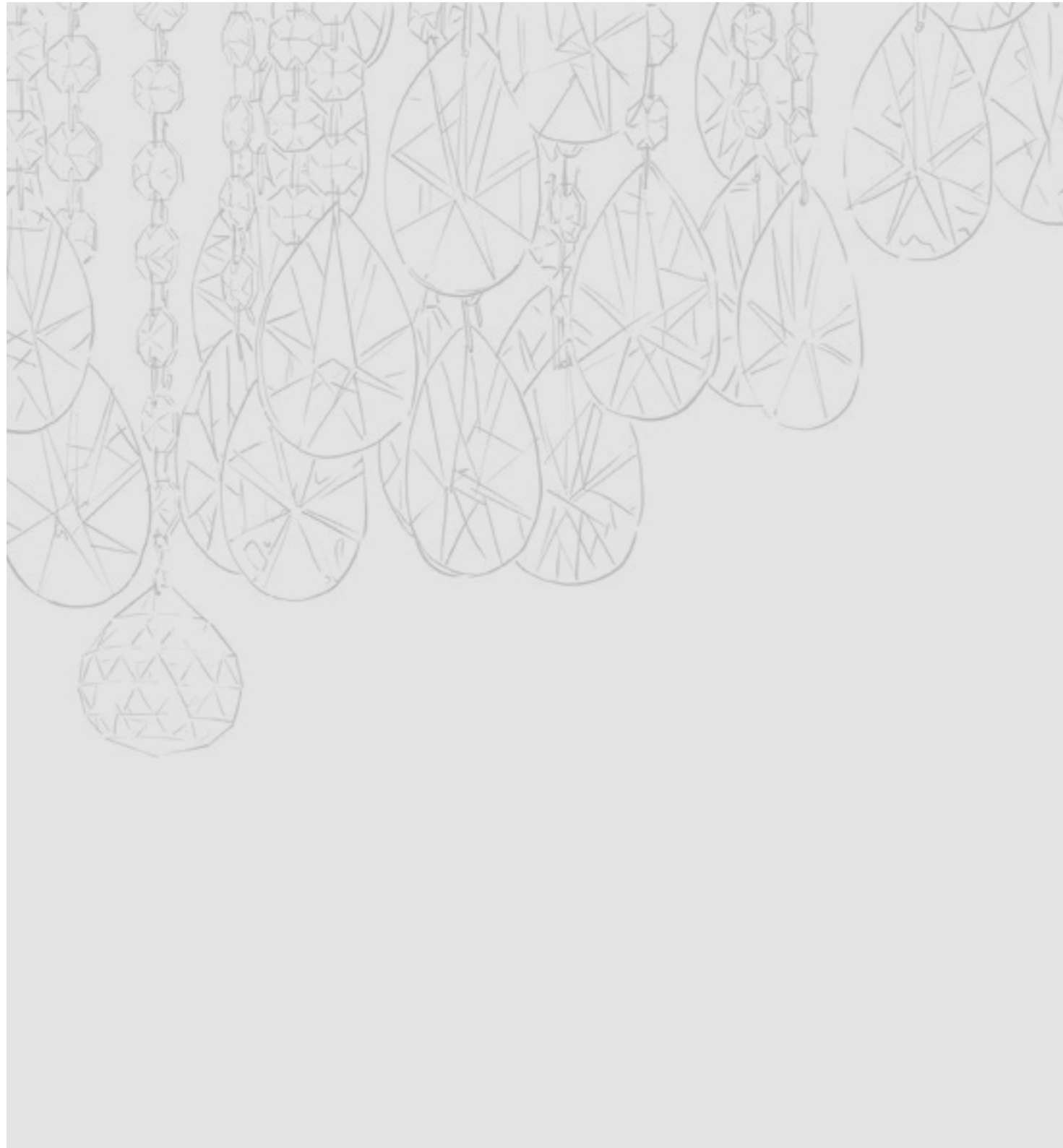


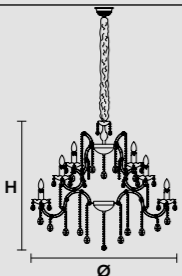
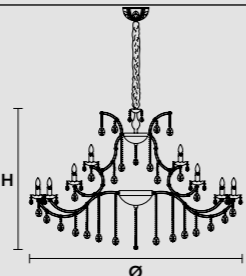
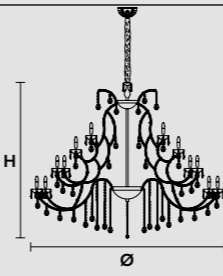
Ø 220 cm / 86.61"
H 75 cm / 29.52"
W 69 kg / 152.11 lb

WW 60×E14×40 W max (not included)
USA 60×E12×40 W max (not included)

RW-DW 60×LED source - 240 W

VE 984/60

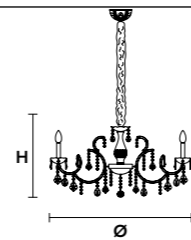


VE 918/30	VE 918/48	VE 918/72
		
<p>Ø 100 cm / 39.37"</p> <p>H 90 cm / 35.43"</p> <p>W 28 kg / 61.72 lb</p> <p>WW 30×E14×40 W max (not included)</p> <p>USA 30×E12×40 W max (not included)</p> <p>RW-DW 30×LED source -120 W tot</p>	<p>Ø 165 cm / 64.96"</p> <p>H 110 cm / 43.30"</p> <p>W 50 kg / 110.23 lb</p> <p>WW 48×E14×40 W max (not included)</p> <p>USA 48×E12×40 W max (not included)</p> <p>RW-DW 48×LED source -192 W tot</p>	<p>Ø 200 cm / 78.74"</p> <p>H 160 cm / 62.99"</p> <p>W 90 kg / 198.41 lb</p> <p>WW 72×E14×40 W max (not included)</p> <p>USA 72×E12×40 W max (not included)</p> <p>RW-DW 72×LED source -288 W tot</p>

VE 918/30



VE 931/12 CE




Ø 100 cm / 39.37"
 H 46 cm / 18.11"
 W 18 kg / 39.68 lb

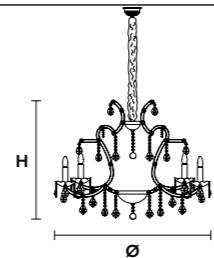
WW 12×E14×40 W max (not included)
 USA 12×E12×40 W max (not included)

RW-DW 12×LED source - 48 W tot

VE 931/12

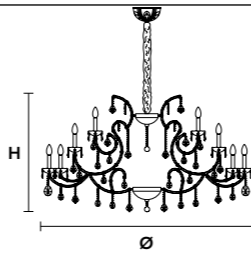


VE 934/12 



Ø 95 cm / 37.40"
H 80 cm / 31.49"
W 17 kg / 37.47 lb
WW 12×E14×40 W max (not included)
USA 12×E12×40 W max (not included)
RW-DW 12×LED source – 48 W tot


VE 934/40 

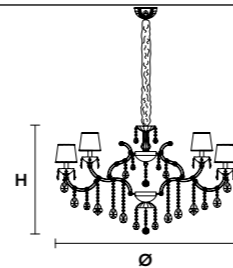


Ø 150 cm / 59.05"
H 95 cm / 37.40"
W 50 kg / 110.23 lb
WW 40×E14×40 W max (not included)
USA 40×E12×40 W max (not included)
RW-DW 40×LED source – 160 W

VE 934/40



VE 950/18 




Ø 105 cm / 41.33"
H 65 cm / 25.59"
W 18 kg / 39.68 lb

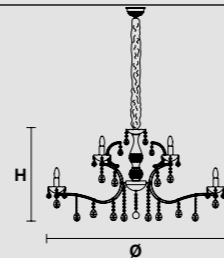
WW 18×E14×40 W max (not included)
USA 18×E12×40 W max (not included)

RW-DW 18×LED source - 72 W tot

VE 950/18



VE 917/15 CE 



Ø 85 cm / 33.46"
 H 60 cm / 23.62"
 W 18 kg / 39.68 lb

WW 15×E14×40 W max (not included)
 USA 15×E12×40 W max (not included)

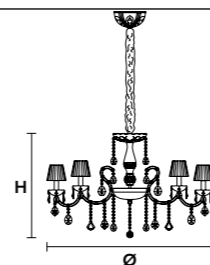
RW-DW 15×LED source - 60 W tot



VE 917/15



VE 975/16 

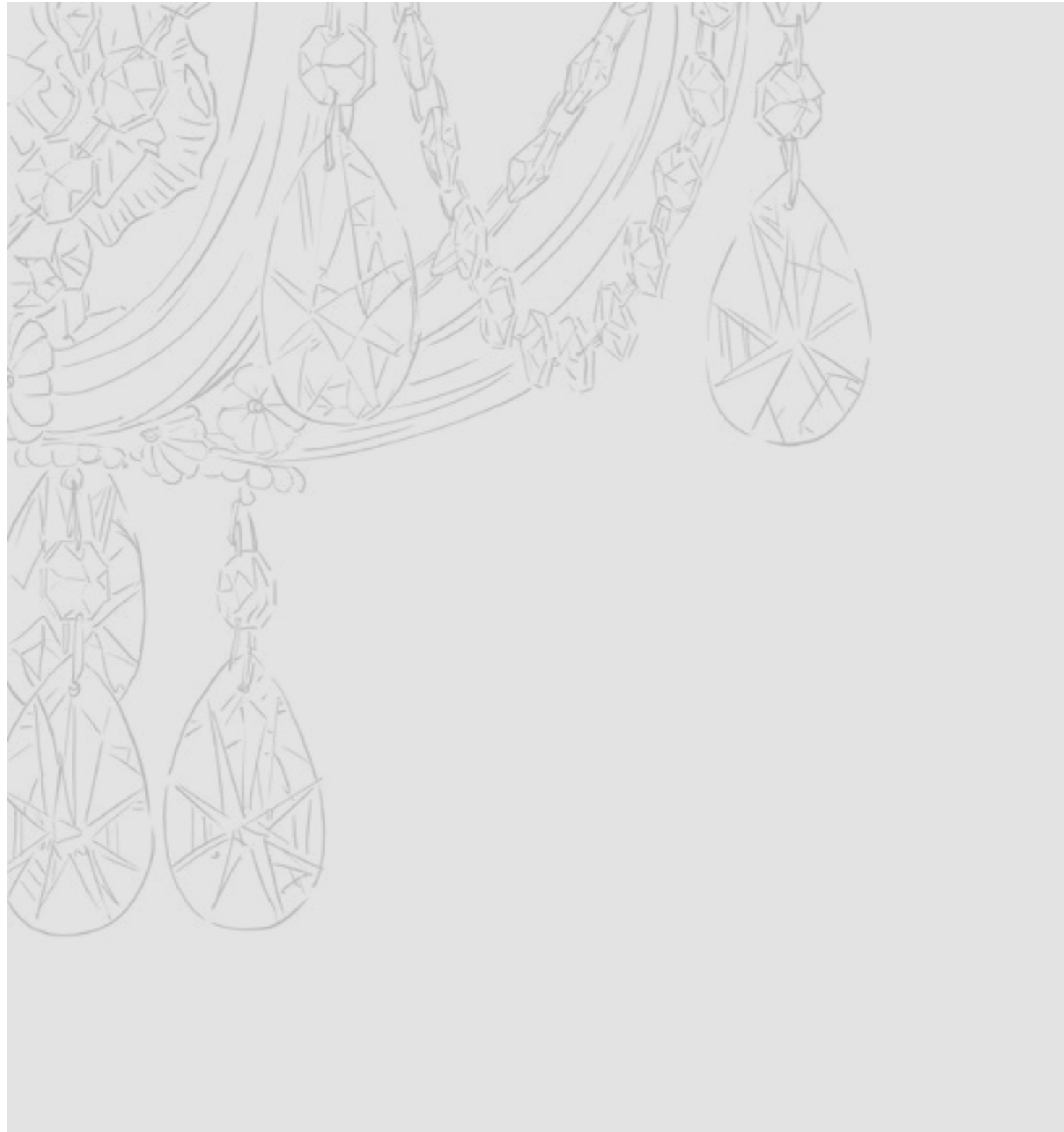



Ø 110 cm / 43.31"
H 70 cm / 27.55"
W 28 kg / 61.72 lb

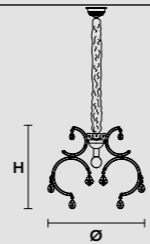
WW 16×E14×40 W max (not included)
USA 16×E12×40 W max (not included)

RW-DW 16×LED source - 64 W tot

VE 975/16

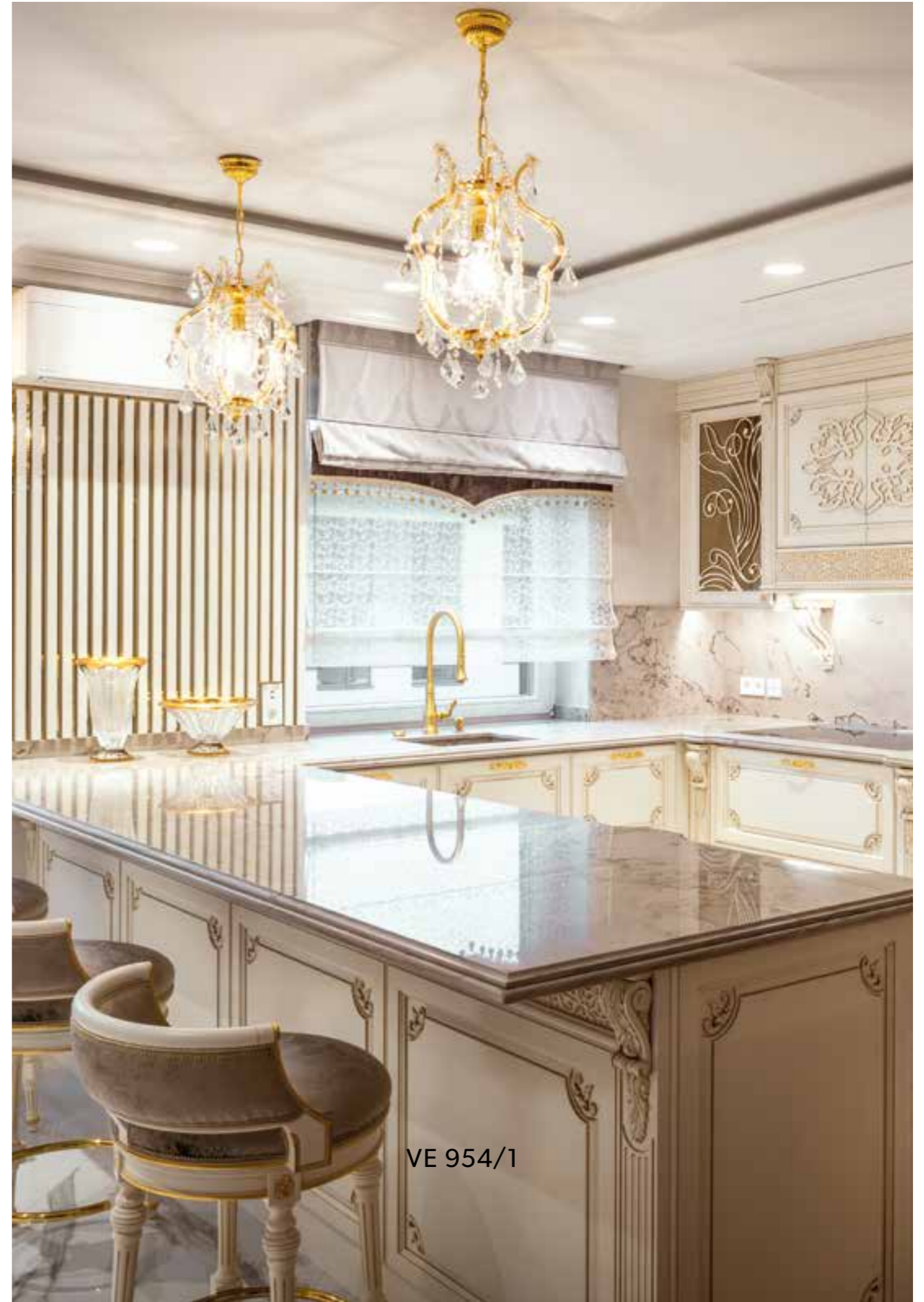


VE 956/1 CE 

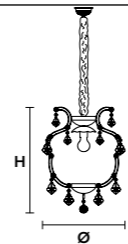


Ø 40 cm / 15.75"
 H 40 cm / 15.75"
 W 7 kg / 15.43 lb
 WW 1xE27x60 W max (not included)
 USA 1xE26x60 W max (not included)
 RW-DW 1xLED source -4 W tot

VE 956/1




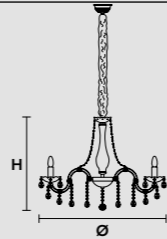
VE 954/1 




- Ø 40 cm / 15.75"
- H 50 cm / 19.69"
- W 6 kg / 13.22 lb
- WW 1x E27x60 W max (not included)
- USA 1x E26x60 W max (not included)
- RW-DW 1x LED source - 4 W tot

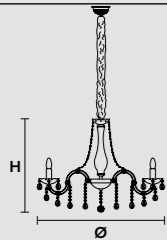


VE 940/5 




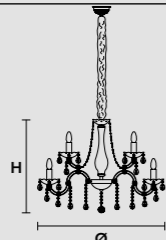
Ø 60 cm / 23.62"
 H 50 cm / 19.68"
 W 7 kg / 15.43 lb
 WW 5×E14×40 W max (not included)
 USA 5×E12×40 W max (not included)
 RW-DW 5×LED source – 20 W tot

VE 940/8 




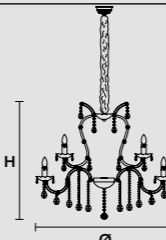
Ø 62 cm / 24.40"
 H 50 cm / 19.68"
 W 8.3 kg / 18.29 lb
 WW 8×E14×40 W max (not included)
 USA 8×E12×40 W max (not included)
 RW-DW 8×LED source – 32 W tot

VE 940/12 




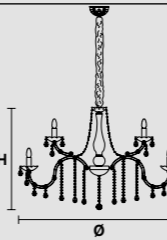
Ø 65 cm / 25.59"
 H 57 cm / 22.44"
 W 12 kg / 26.45 lb
 WW 12×E14×40 W max (not included)
 USA 12×E12×40 W max (not included)
 RW-DW 12×LED source – 48 W tot

VE 940/18 



Ø 105 cm / 41.33"
 H 85 cm / 33.46"
 W 25 kg / 55.11 lb
 WW 18×E14×40 W max (not included)
 USA 18×E12×40 W max (not included)
 RW-DW 18×LED source – 72 W tot

VE 940/24 



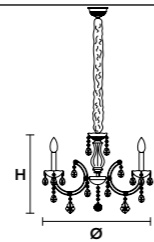
Ø 100 cm / 39.37"
 H 70 cm / 27.55"
 W 20 kg / 44.09 lb
 WW 24×E14×40 W max (not included)
 USA 24×E12×40 W max (not included)
 RW-DW 24×LED source – 96 W tot



VE 940/5

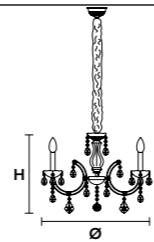


VE 944/3 



Ø 47 cm / 18.50"
H 42 cm / 16.53"
W 3.5 kg / 7.71 lb
WW 3×E14×40 W max (not included)
USA 3×E12×40 W max (not included)
RW-DW 3×LED source -12 W tot

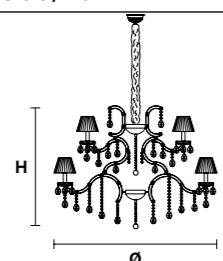
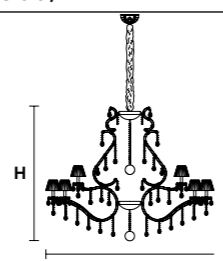
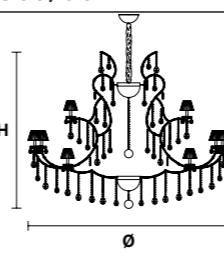
VE 944/5 



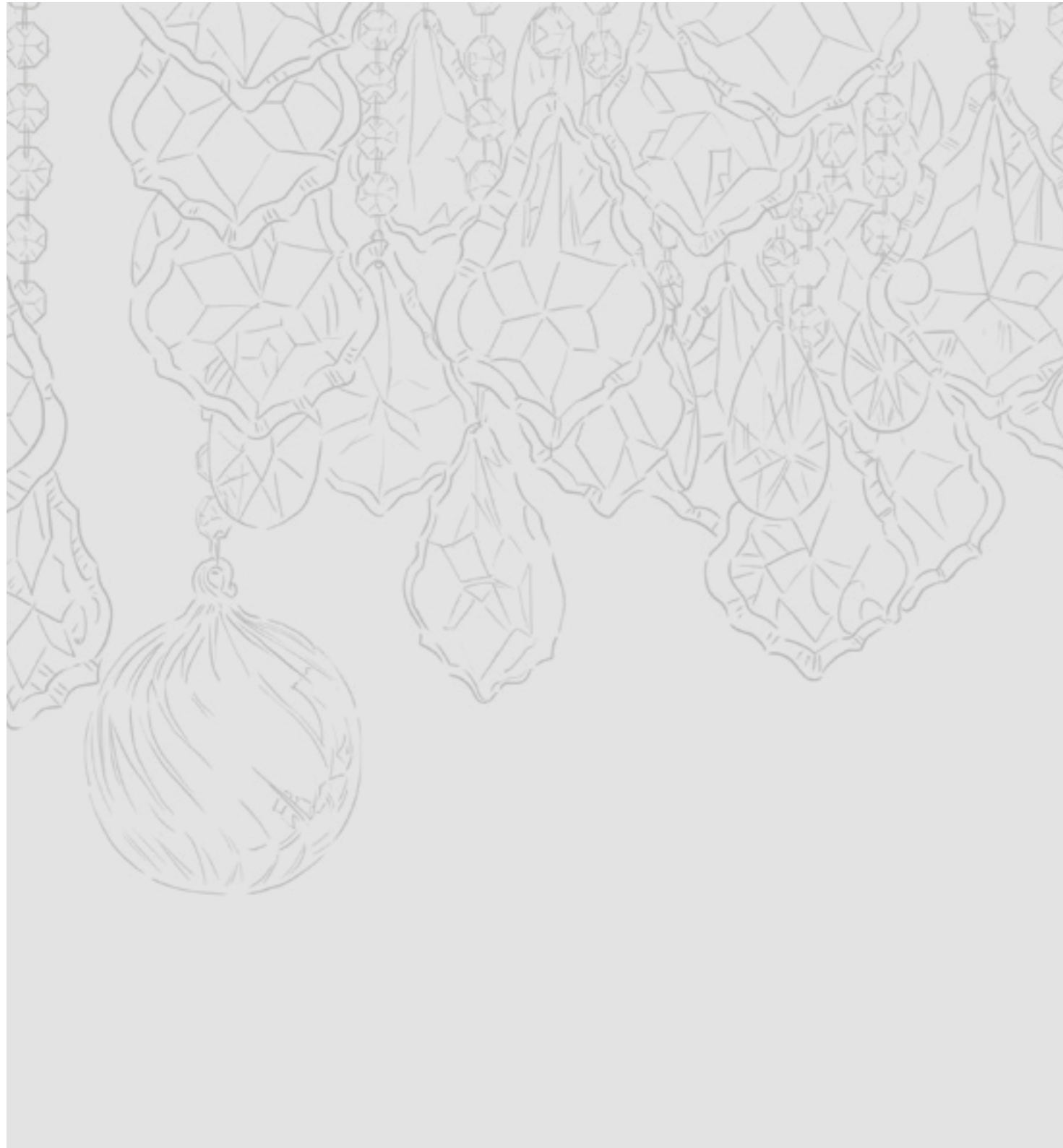
Ø 47 cm / 18.50"
H 42 cm / 16.53"
W 5 kg / 11.02 lb
WW 5×E14×40 W max (not included)
USA 5×E12×40 W max (not included)
RW-DW 5×LED source -20 W tot

VE 944/5

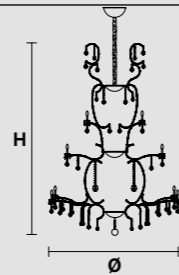


VE 903/15	VE 903/24	VE 903/56
		
<p>Ø 90 cm / 35.43"</p> <p>H 70 cm / 27.55"</p> <p>W 30 kg / 66.13 lb</p> <p>WW 15×E14×40 W max (not included)</p> <p>USA 15×E12×40 W max (not included)</p> <p>RW-DW 15×LED source - 60 W tot</p>	<p>Ø 150 cm / 59.05"</p> <p>H 120 cm / 47.24"</p> <p>W 48 kg / 105.82 lb</p> <p>WW 24×E14×40 W max (not included)</p> <p>USA 24×E12×40 W max (not included)</p> <p>RW-DW 24×LED source - 96 W tot</p>	<p>Ø 210 cm / 82.67"</p> <p>H 180 cm / 70.86"</p> <p>W 140 kg / 308.6 lb</p> <p>WW 56×E14×40 W max (not included)</p> <p>USA 56×E12×40 W max (not included)</p> <p>RW-DW 56×LED source - 224</p>

VE 903/56 CG



VE 901/70 CE



Ø 260 cm / 102.40"
 H 300 cm / 118.20"
 W 120 kg / 264.5 lb

WW 70×E14×40 W max (not included)
 USA 70×E12×40 W max (not included)

RW-DW 70×LED source -280 W tot



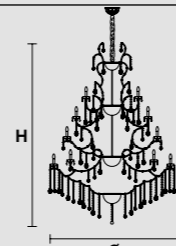
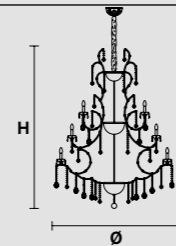
VE 901/70 DW



VE 907/35



VE 907/65



Ø 140 cm / 55.10"
H 210 cm / 82.70"
W 80 kg / 176.5 lb

WW 35×E14×40 W max (not included)
USA 35×E12×40 W max (not included)

RW-DW 35×LED source -140 W tot

Ø 170 cm / 66.92"
H 250 cm / 98.42"
W 120 kg / 264.5 lb

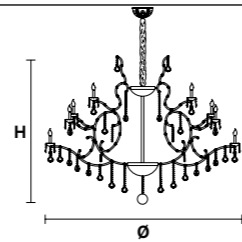
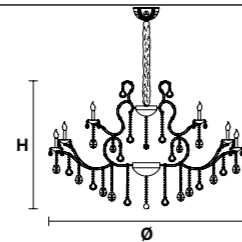
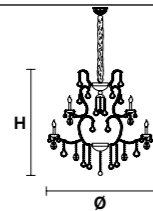
WW 65×E14×40 W max (not included)
USA 65×E12×40 W max (not included)

RW-DW 65×LED source -260 W tot

VE 907/65 RW



VE 909/15 CE VE 909/30 CE VE 909/60 CE

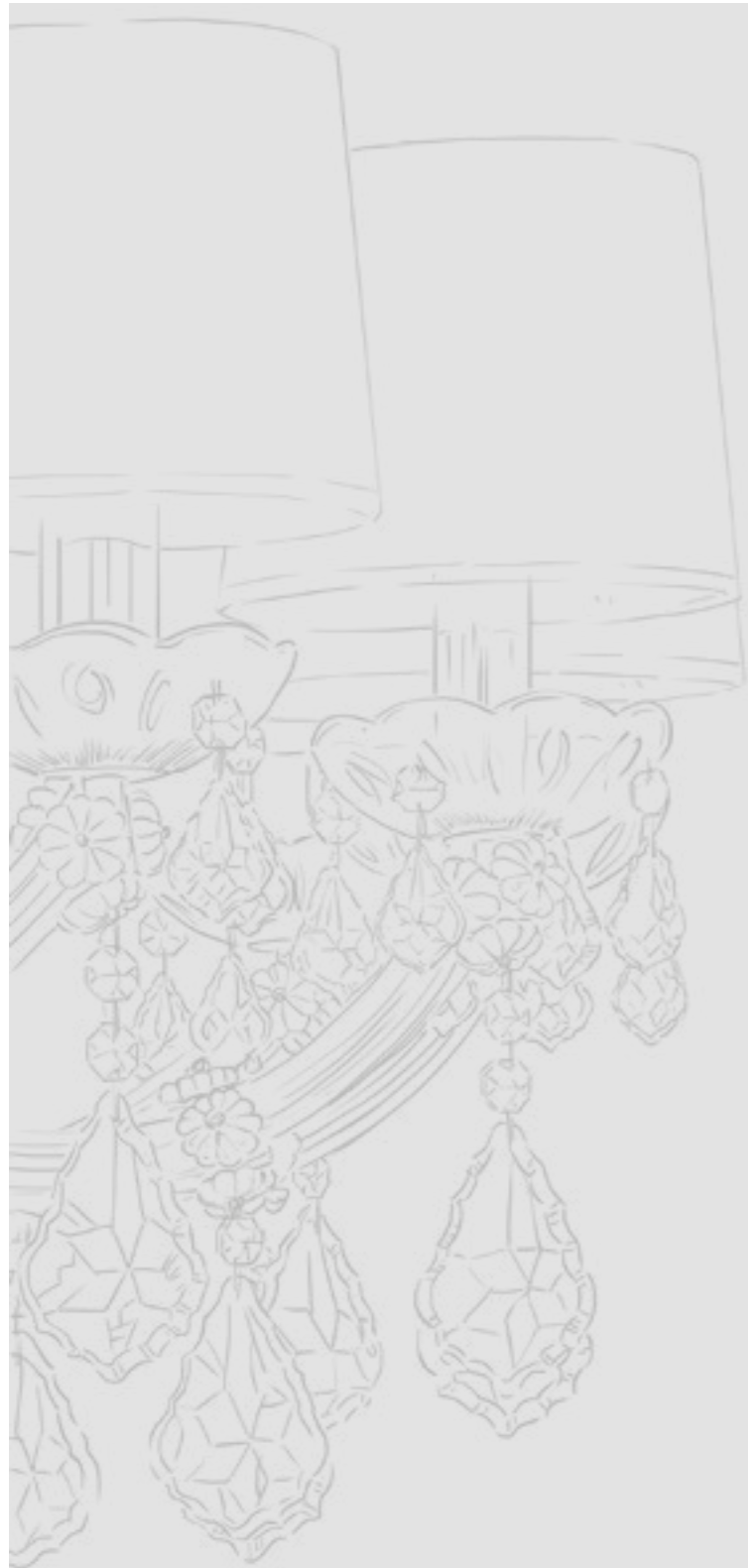


Ø 110 cm / 43.30"
H 110 cm / 43.30"
W 35 kg / 77.16 lb
WW 15×E14×40 W max (not included)
USA 15×E12×40 W max (not included)
RW-DW 15×LED source – 60 W tot

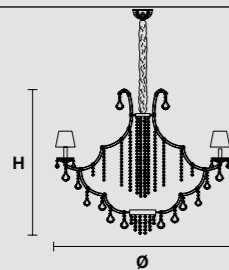
Ø 144 cm / 56.69"
H 102 cm / 40.15"
W 55 kg / 121.25 lb
WW 30×E14×40 W max (not included)
USA 30×E12×40 W max (not included)
RW-DW 30×LED source – 120 W tot

Ø 190 cm / 74.80"
H 145 cm / 57.80"
W 110 kg / 242.5 lb
WW 60×E14×40 W max (not included)
USA 60×E12×40 W max (not included)
RW-DW 60×LED source – 240 W tot

VE 909/30 DW



VE 913/12

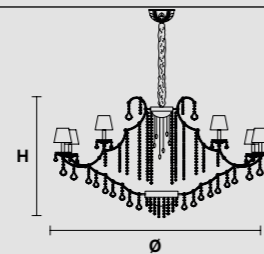


Ø 110 cm / 43.30"
H 95 cm / 37.40"
W 38 kg / 83.77 lb

WW 12×E14×40 W max (not included)
USA 12×E12×40 W max (not included)

RW-DW 12×LED source – 48 W tot

VE 913/36

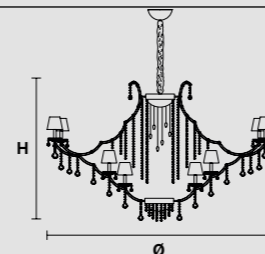


Ø 167 cm / 65.74"
H 98 cm / 38.58"
W 58 kg / 127.86 lb

WW 36×E14×40 W max (not included)
USA 36×E12×40 W max (not included)

RW-DW 36×LED source – 144 W

VE 913/46



Ø 205 cm / 80.70"
H 120 cm / 47.24"
W 100 kg / 220.4 lb

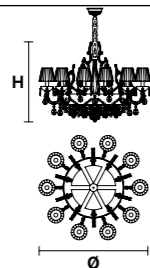
WW 46×E14×40 W max (not included)
USA 46×E12×40 W max (not included)

RW-DW 46×LED source – 184 W

VE 913/36



VE 923/13

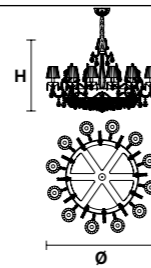


Ø 80 cm / 31.49"
H 65 cm / 25.59"
W 19 kg / 41.88 lb

WW 10×E14×40 W max (not included)
3×E27×60 W max (not included)
USA 10×E12×40 W max (not included)
3×E26×60 W max (not included)

RW-DW 13×LED source -52 W tot

VE 923/18

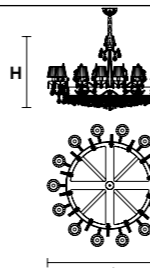


Ø 100 cm / 39.37"
H 65 cm / 25.59"
W 40 kg / 88.18 lb

WW 12×E14×40 W max (not included)
6×E27×60 W max (not included)
USA 12×E12×40 W max (not included)
6×E26×60 W max (not included)

RW-DW 18×LED source -72 W tot

VE 923/21



Ø 125 cm / 49.21"
H 75 cm / 29.52"
W 80 kg / 176.36 lb

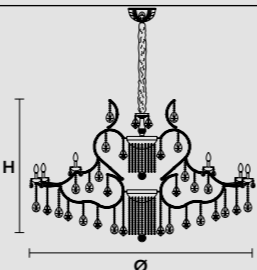
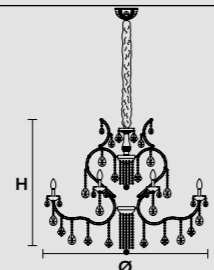
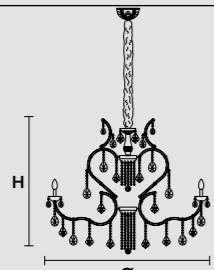
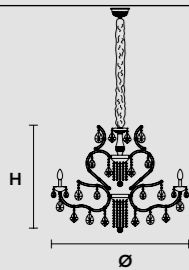
WW 14×E14×40 W max (not included)
7×E27×60 W max (not included)
USA 14×E12×40 W max (not included)
7×E26×60 W max (not included)

RW-DW 21×LED source -84 W tot

VE 923/13



VE 927/12 CE VE 927/16 CE VE 927/24 CE VE 927/30 CE



Ø 85 cm / 33.46"
H 70 cm / 27.55"
W 25 kg / 55.11 lb

Ø 118 cm / 46.45"
H 84 cm / 33.07"
W 33 kg / 72.75 lb

Ø 118 cm / 46.45"
H 84 cm / 33.07"
W 40 kg / 88.18 lb

Ø 165 cm / 64.96"
H 105 cm / 41.38"
W 82 kg / 180.77 lb

WW 12×E14×40 W max (not included)
USA 12×E12×40 W max (not included)
RW-DW 12×LED source - 48W tot

WW 16×E14×40 W max (not included)
USA 16×E12×40 W max (not included)
RW-DW 16×LED source - 64 W tot

WW 24×E14×40 W max (not included)
USA 24×E12×40 W max (not included)
RW-DW 24×LED source - 96 W tot

WW 30×E14×40 W max (not included)
USA 30×E12×40 W max (not included)
RW-DW 30×LED source - 120 W tot

VE 927/16

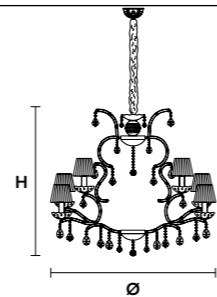


VE 935/12	VE 935/18	VE 935/30
<p>Ø 75 cm / 29.52"</p> <p>H 60 cm / 23.62"</p> <p>W 20 kg / 44.09 lb</p>	<p>Ø 120 cm / 47.24"</p> <p>H 75 cm / 29.52"</p> <p>W 30 kg / 66.13 lb</p>	<p>Ø 170 cm / 66.92"</p> <p>H 85 cm / 33.46"</p> <p>W 50 kg / 110.23 lb</p>
<p>WW 12×E14×40 W max (not included)</p> <p>USA 12×E12×40 W max (not included)</p> <p>RW-DW 12×LED source - 48 W tot</p>	<p>WW 18×E14×40 W max (not included)</p> <p>USA 18×E12×40 W max (not included)</p> <p>RW-DW 18×LED source - 72 W tot</p>	<p>WW 30×E14×40 W max (not included)</p> <p>USA 30×E12×40 W max (not included)</p> <p>RW-DW 30×LED source - 120 W tot</p>

VE 935/30

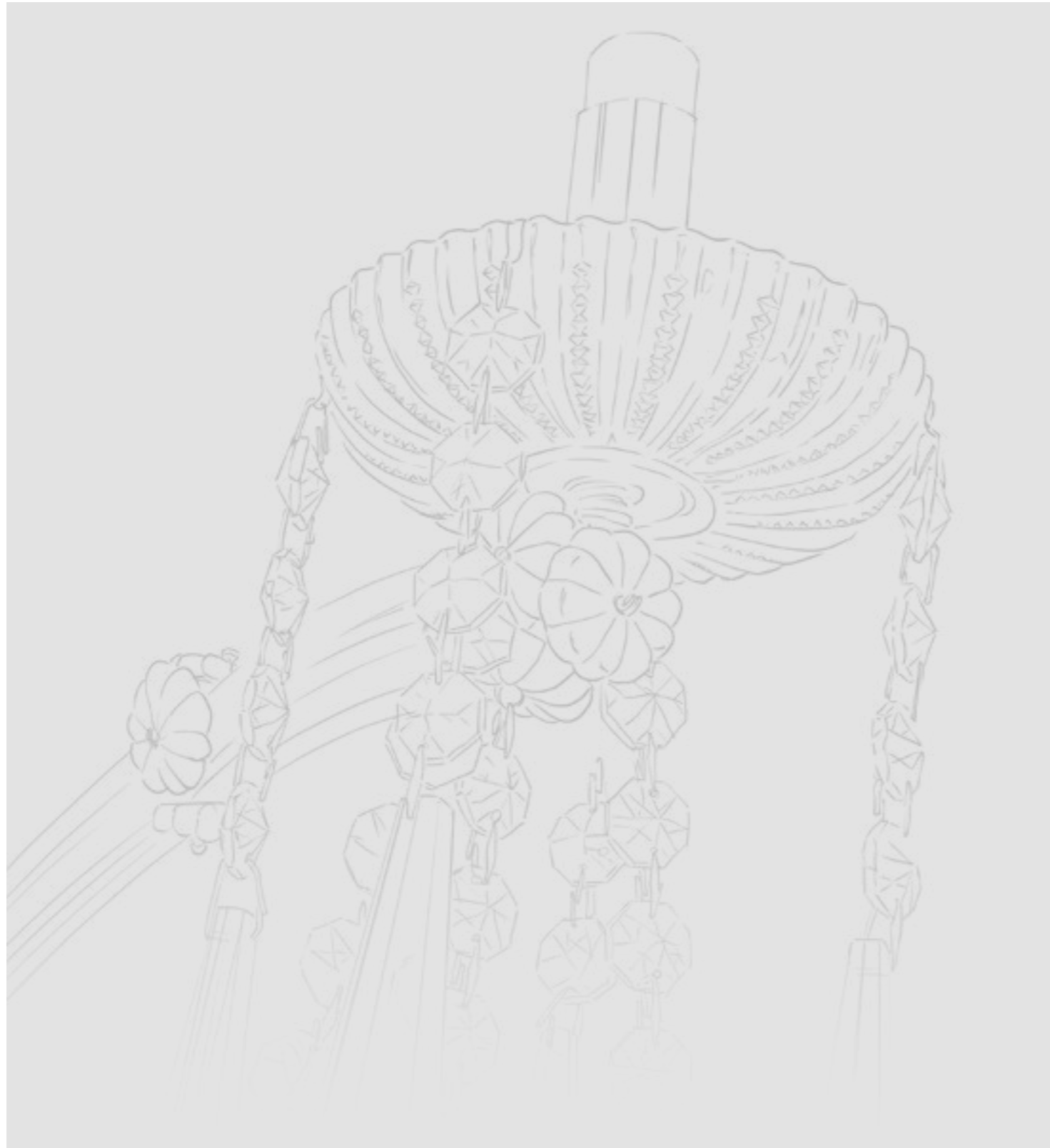


VE 925/15 CE

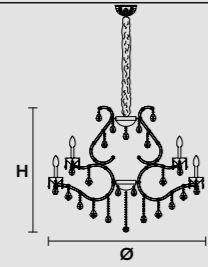


- Ø 100 cm / 39.37"
- H 80 cm / 31.49"
- W 24 kg / 52.91 lb
- WW 15×E14×40 W max (not included)
- USA 15×E12×40 W max (not included)
- RW-DW 15×LED source - 60 W tot

VE 925/15



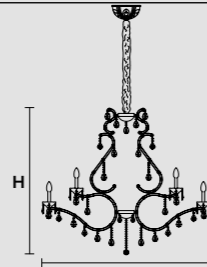
VE 951/15 CE VE 951/24 CE VE 951/40 CE



Ø 105 cm / 41.33"
H 85 cm / 33.46"
W 20 kg / 44.09 lb

WW 15×E14×40 W max (not included)
USA 15×E12×40 W max (not included)

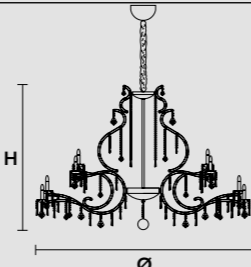
RW-DW 15×LED source -60 W tot



Ø 145 cm / 57.09"
H 125 cm / 49.21"
W 42.5 kg / 93.69 lb

WW 24×E14×40 W max (not included)
USA 24×E12×40 W max (not included)

RW-DW 24×LED source -96 W tot



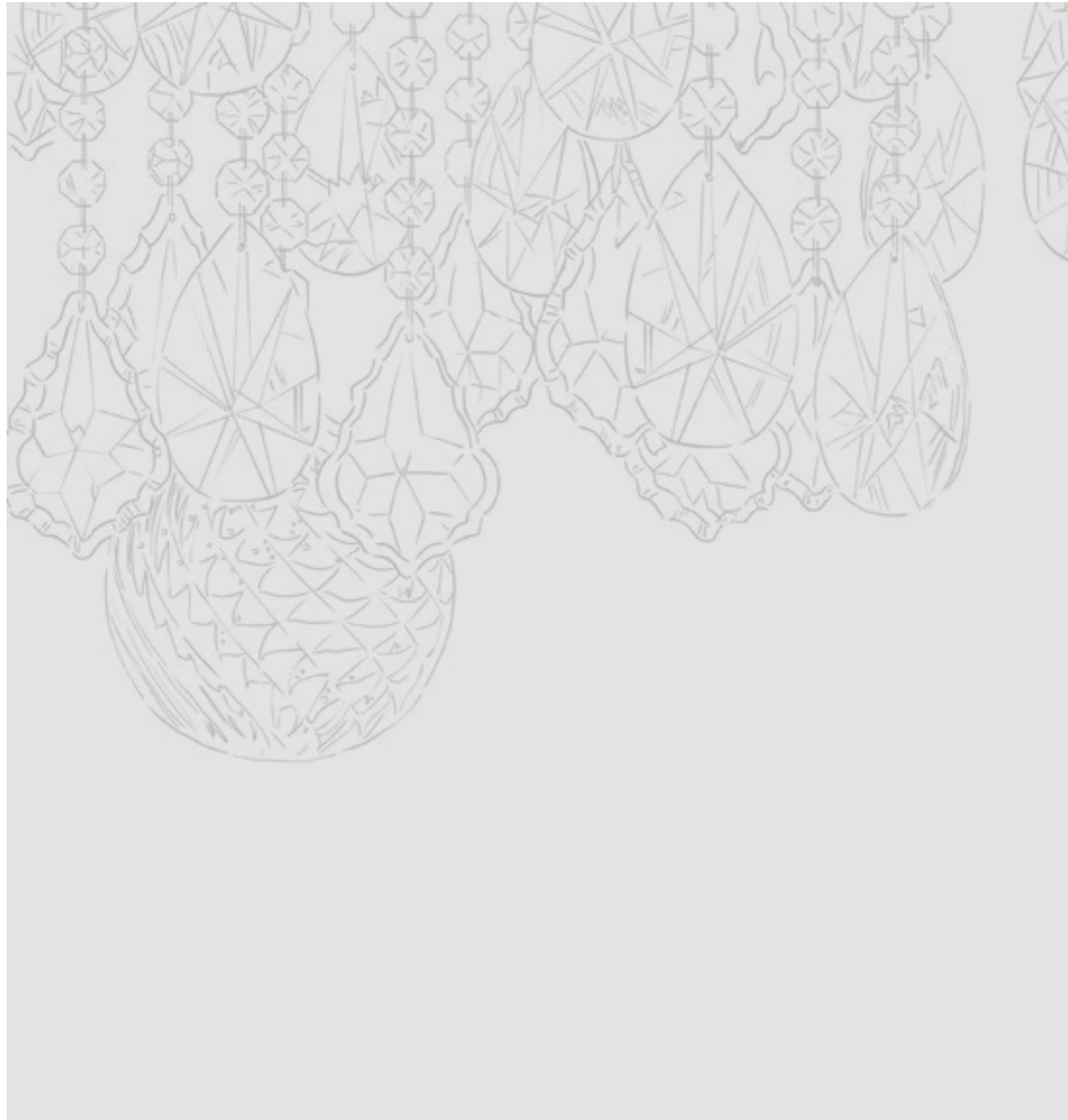
Ø 200 cm / 78.74"
H 135 cm / 53.14"
W 80 kg / 176.36 lb

WW 40×E14×40 W max (not included)
USA 40×E12×40 W max (not included)

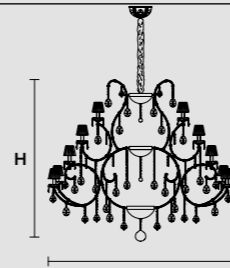
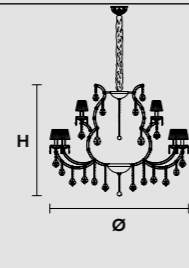
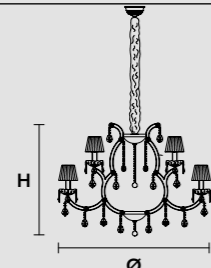
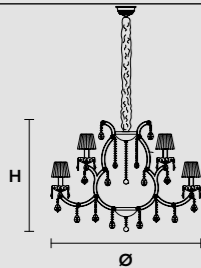
RW-DW 40×LED source -160 W tot



VE 951/24 RW



VE 933/12 CE VE 933/15 CE VE 933/24 CE VE 933/50 CE



Ø 80 cm / 31.49"
 H 65 cm / 25.59"
 W 20 kg / 44.09 lb
 WW 12×E14×40 W max (not included)
 USA 12×E12×40 W max (not included)
 RW-DW 12×LED source – 48 W tot

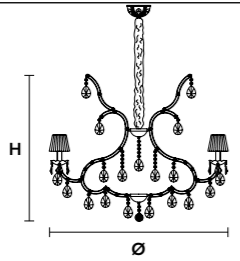
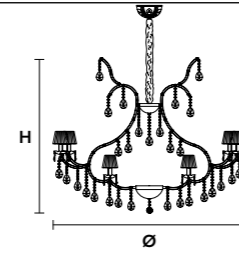
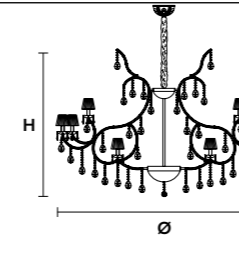
Ø 80 cm / 31.49"
 H 65 cm / 25.59"
 W 20 kg / 44.09 lb
 WW 15×E14×40 W max (not included)
 USA 15×E12×40 W max (not included)
 RW-DW 15×LED source – 40 W tot

Ø 120 cm / 47.24"
 H 110 cm / 43.30"
 W 45 kg / 99.20 lb
 WW 24×E14×40 W max (not included)
 USA 24×E12×40 W max (not included)
 RW-DW 24×LED source – 96 W tot

Ø 160 cm / 62.99"
 H 155 cm / 61.02"
 W 83 kg / 182.98 lb
 WW 50×E14×40 W max (not included)
 USA 50×E12×40 W max (not included)
 RW-DW 50×LED source – 200W tot

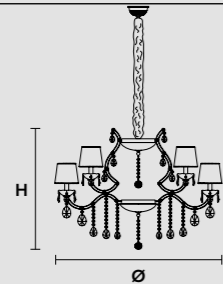
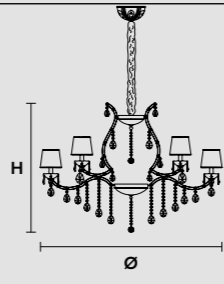
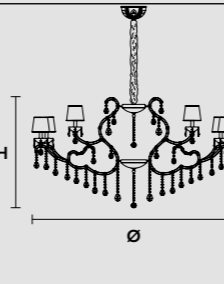
VE 933/50



VE 959/12	VE 959/30	VE 959/56
		
<p>Ø 115 cm / 45.27"</p> <p>H 95 cm / 37.40"</p> <p>W 30 kg / 66.13 lb</p> <p>WW 12×E14×40 W max (not included) USA 12×E12×40 W max (not included)</p> <p>RW-DW 12×LED source – 48 W tot</p>	<p>Ø 155 cm / 61.02"</p> <p>H 125 cm / 49.21"</p> <p>W 48 kg / 105.82 lb</p> <p>WW 30×E14×40 W max (not included) USA 30×E12×40 W max (not included)</p> <p>RW-DW 30×LED source – 120 W</p>	<p>Ø 200 cm / 78.74"</p> <p>H 140 cm / 55.11"</p> <p>W 84 kg / 185.18 lb</p> <p>WW 56×E14×40 W max (not included) USA 56×E12×40 W max (not included)</p> <p>RW-DW 56×LED source – 224 W</p>

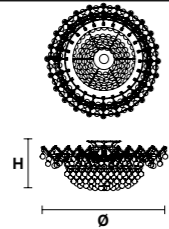
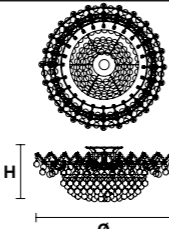
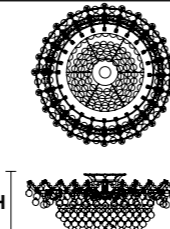
VE 959/12 CG



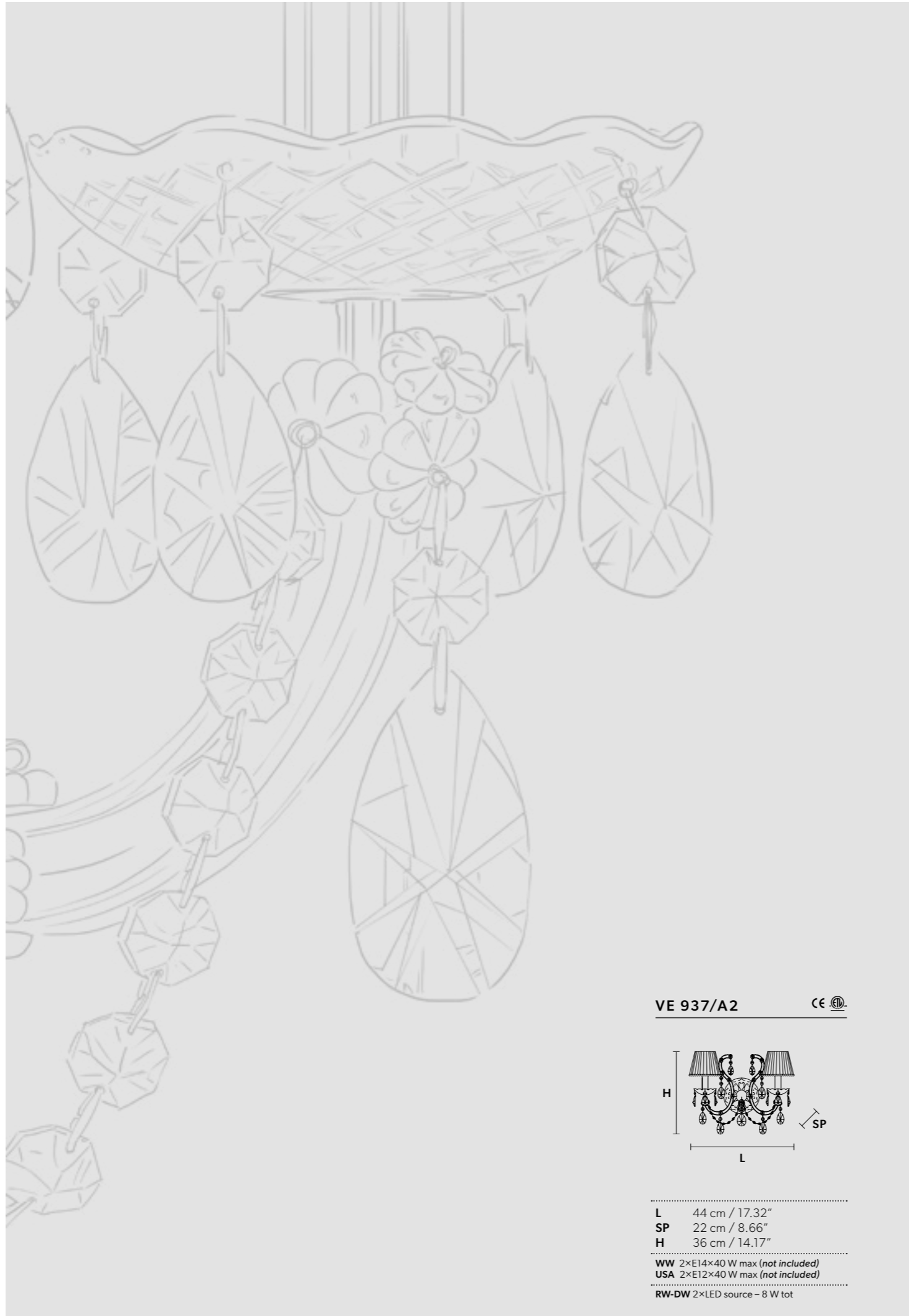
VE 989/15	VE 989/24	VE 989/36
		
<p>Ø 95 cm / 37.40"</p> <p>H 55 cm / 21.63"</p> <p>W 17 kg / 37.47 lb</p> <p>WW 15×E14×40 W max (not included)</p> <p>USA 15×E12×40 W max (not included)</p> <p>RW-DW 15×LED source – 60 W tot</p>	<p>Ø 140 cm / 55.11"</p> <p>H 80 cm / 31.49"</p> <p>W 30 kg / 66.13 lb</p> <p>WW 24×E14×40 W max (not included)</p> <p>USA 24×E12×40 W max (not included)</p> <p>RW-DW 24×LED source – 96 W tot</p>	<p>Ø 165 cm / 64.96"</p> <p>H 90 cm / 35.43"</p> <p>W 48 kg / 105.82 lb</p> <p>WW 40×E14×40 W max (not included)</p> <p>USA 40×E12×40 W max (not included)</p> <p>RW-DW 36×LED source – 144 W</p>


VE 989/15 DW

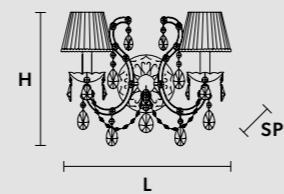


VE 919/PL10	CE	VE 919/PL12	CE	VE 919/PL20	CE
					
Ø 90 cm / 35.43"		Ø 105 cm / 41.33"		Ø 130 cm / 51.18"	
H 35 cm / 13.77"		H 35 cm / 13.77"		H 45 cm / 17.71"	
W 34 kg / 74.95 lb		W 44 kg / 97 lb		W 80 kg / 176.36 lb	
WW 10×E14×40 W max (not included) USA 10×E12×40 W max (not included)		WW 12×E14×40 W max (not included) USA 12×E12×40 W max (not included)		WW 20×E14×40 W max (not included) USA 20×E12×40 W max (not included)	
RW-DW 10×LED source -40 W tot		RW-DW 12×LED source -48 W tot		RW-DW 20×LED source -80 W tot	

VE 919/PL12



VE 937/A2 



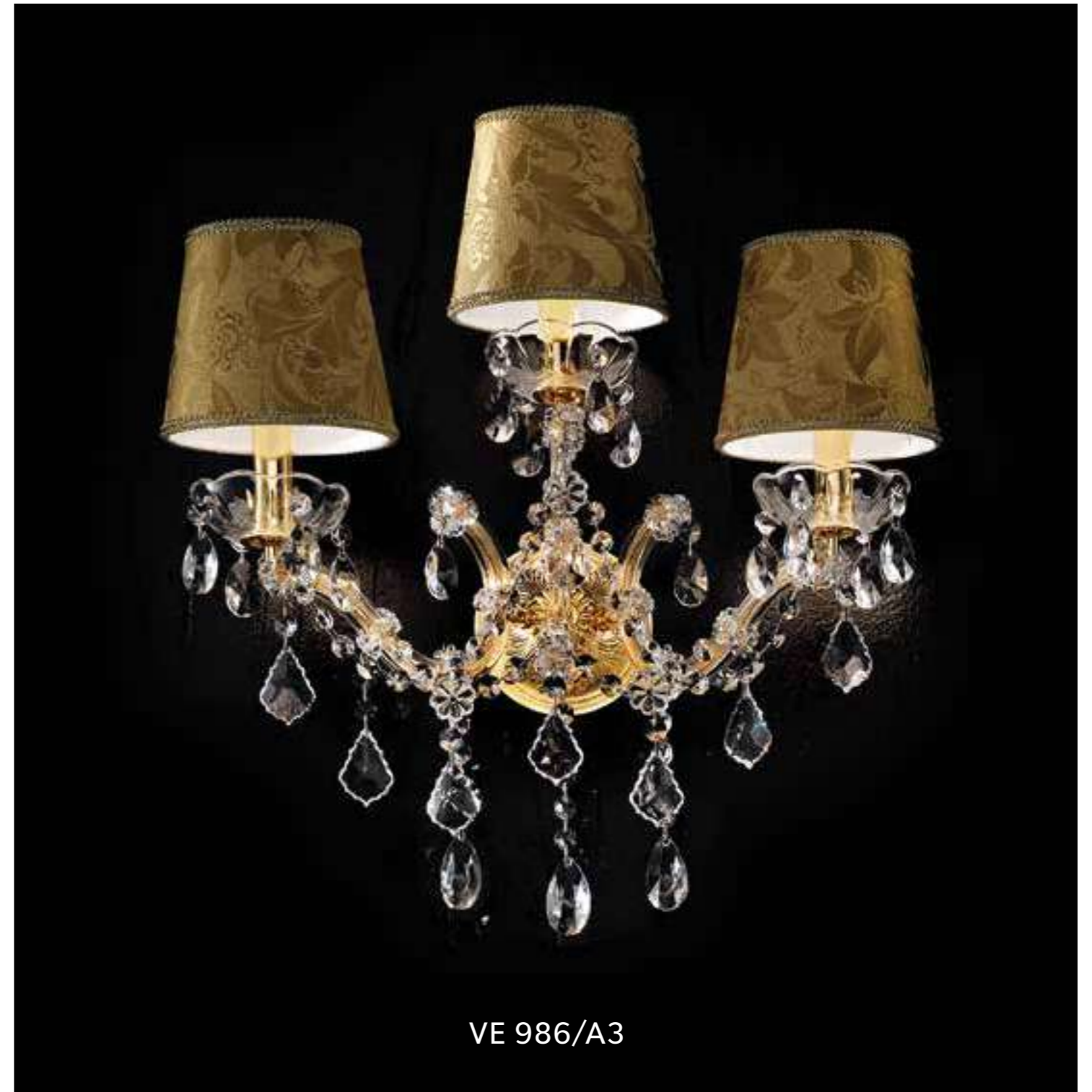
L	44 cm / 17.32"
SP	22 cm / 8.66"
H	36 cm / 14.17"
.....	
WW	2×E14×40 W max (not included)
USA	2×E12×40 W max (not included)
.....	
RW-DW	2×LED source – 8 W tot




VE 937/A2

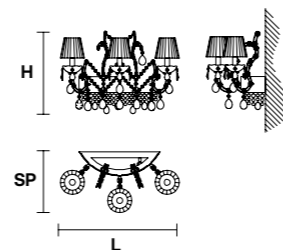


VE 921/A3+1




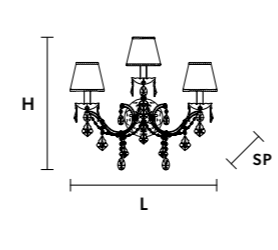
VE 986/A3

VE 921/A3+1 

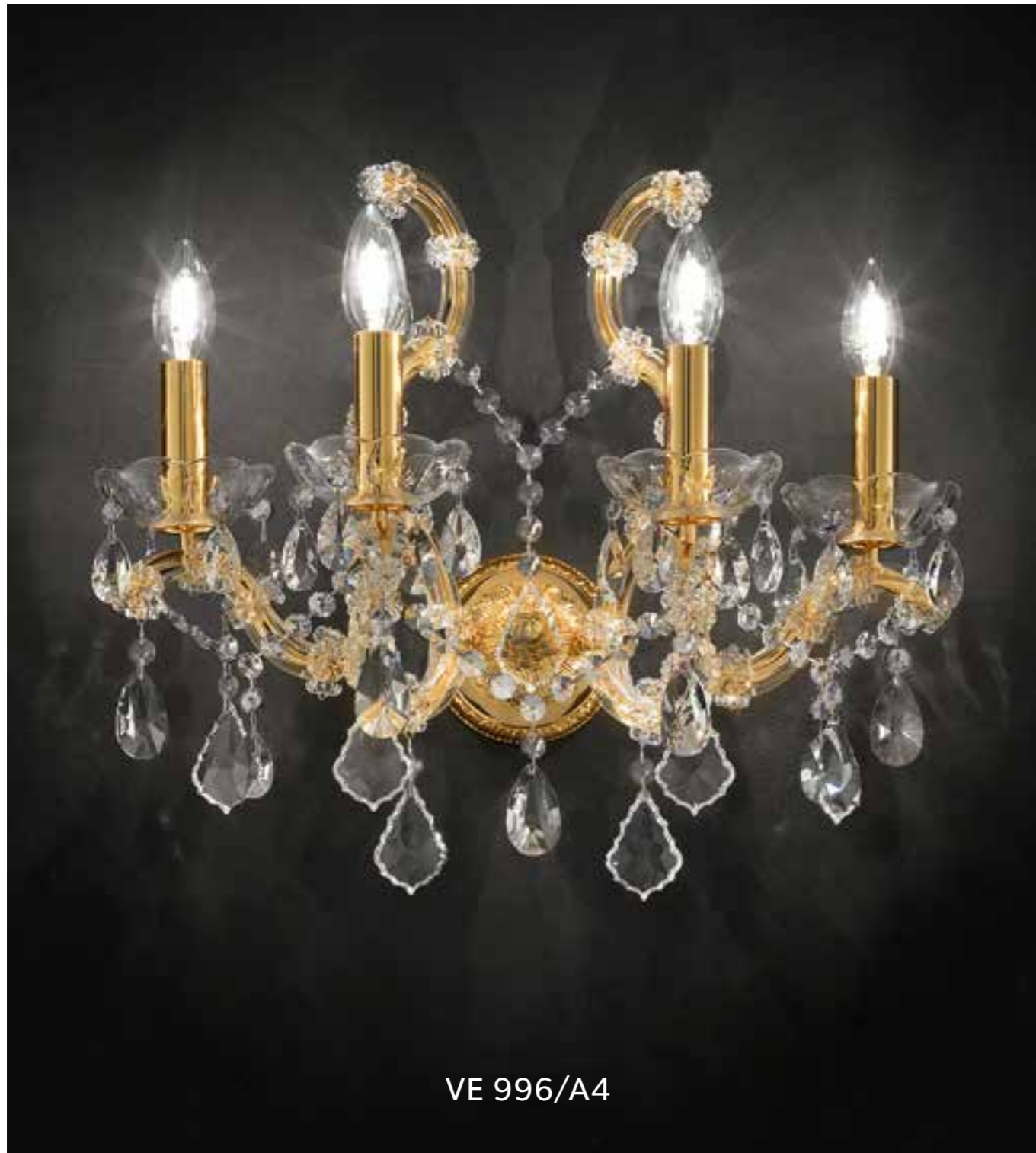


L 60 cm / 23.62"
 SP 30 cm / 11.81"
 H 40 cm / 15.75"
 WW 4×E14×40 W max (not included)
 USA 4×E12×40 W max (not included)
 RW-DW 4×LED source - 16 W tot

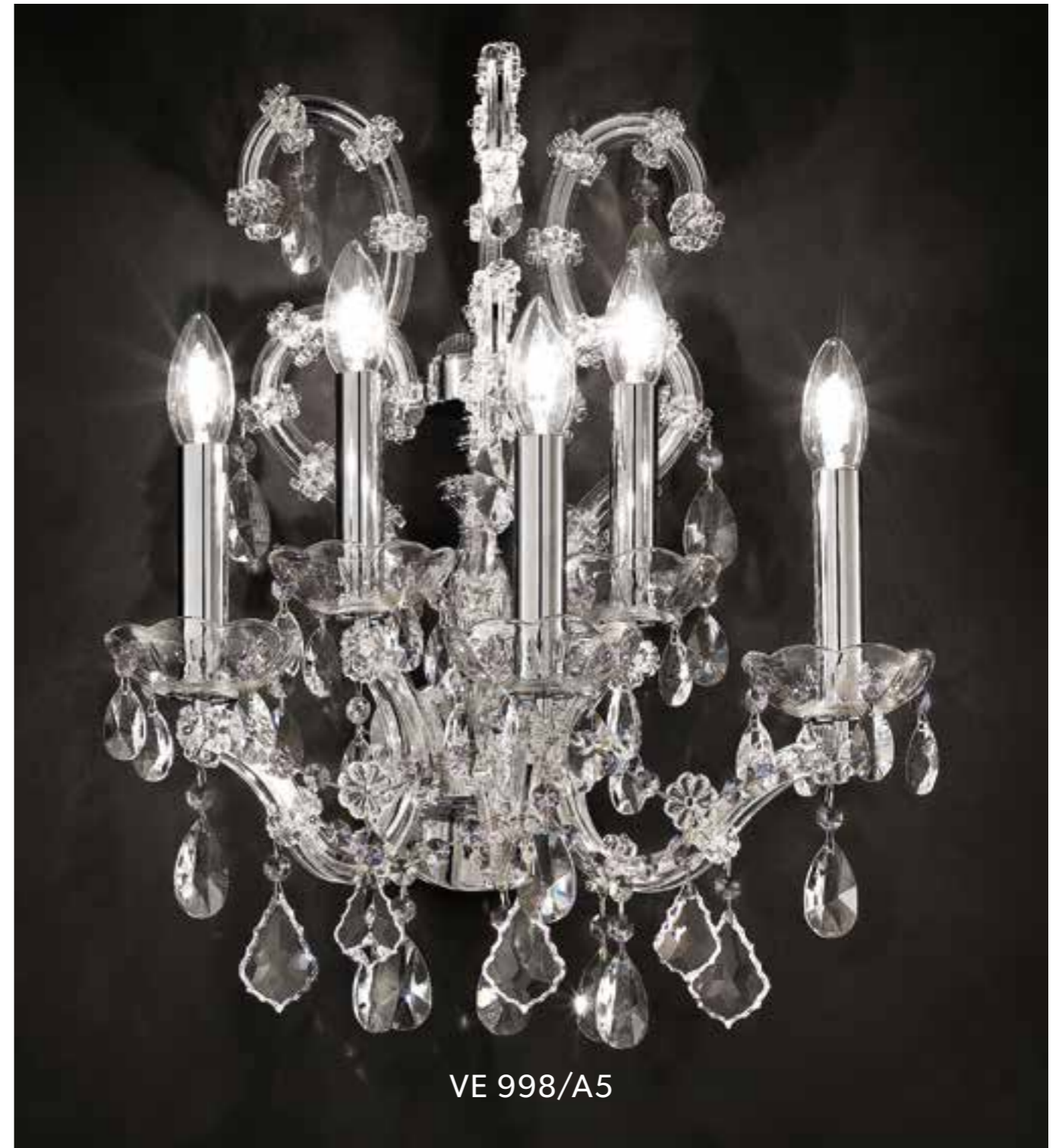
VE 986/A3 



L 50 cm / 19.69"
 SP 25 cm / 9.84"
 H 55 cm / 21.64"
 WW 3×E14×40 W max (not included)
 USA 3×E12×40 W max (not included)
 RW-DW 3×LED source - 12 W tot

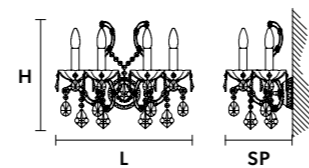


VE 996/A4



VE 998/A5


VE 996/A4 

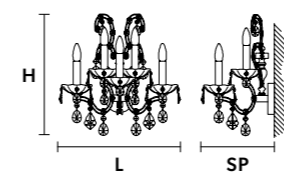


L 48 cm / 18.90"
 SP 27 cm / 10.63"
 H 41 cm / 16.14"

WW 4×E14×40 W max (not included)
 USA 4×E12×40 W max (not included)

RW-DW 4×LED source -16 W tot

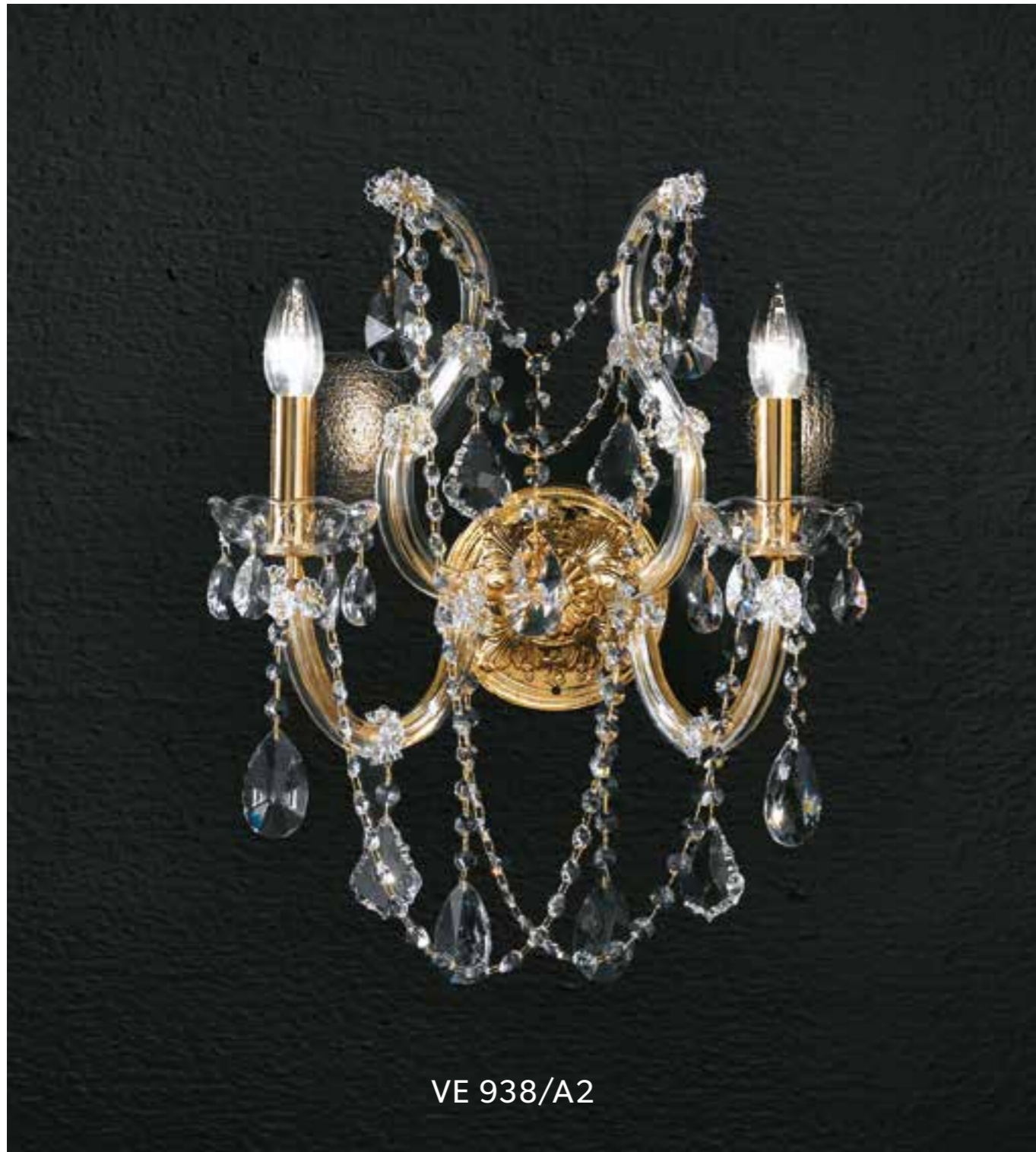
VE 998/A5 



L 42 cm / 16.54"
 SP 32 cm / 12.60"
 H 53 cm / 20.87"

WW 5×E14×40 W max (not included)
 USA 5×E12×40 W max (not included)

RW-DW 5×LED source - 20 W tot



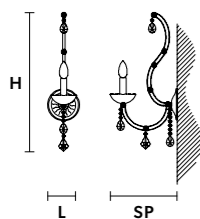
VE 938/A2



VE 938/TL5

VE 938/STL5

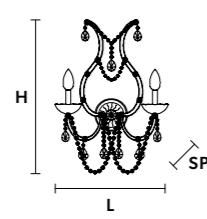
VE 938/A1 CE VE 938/A2 CE VE 938/STL5 CE VE 938/TL5 CE



L 15 cm / 5.91"
SP 22 cm / 8.66"
H 40 cm / 15.75"

WW 1x E14x40 W max (not included)
USA 1x E12x40 W max (not included)

RW-DW 1x LED source - 4 W tot



L 30 cm / 11.81"
SP 22 cm / 8.66"
H 50 cm / 19.69"

WW 2x E14x40 W max (not included)
USA 2x E12x40 W max (not included)

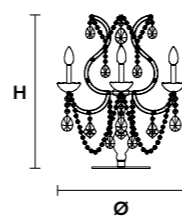
RW-DW 2x LED source - 8 W tot



Ø 50 cm / 19.69"
H 185 cm / 72.83"

WW 5x E14x40 W max (not included)
USA 5x E12x40 W max (not included)

RW-DW 5x LED source - 20 W tot



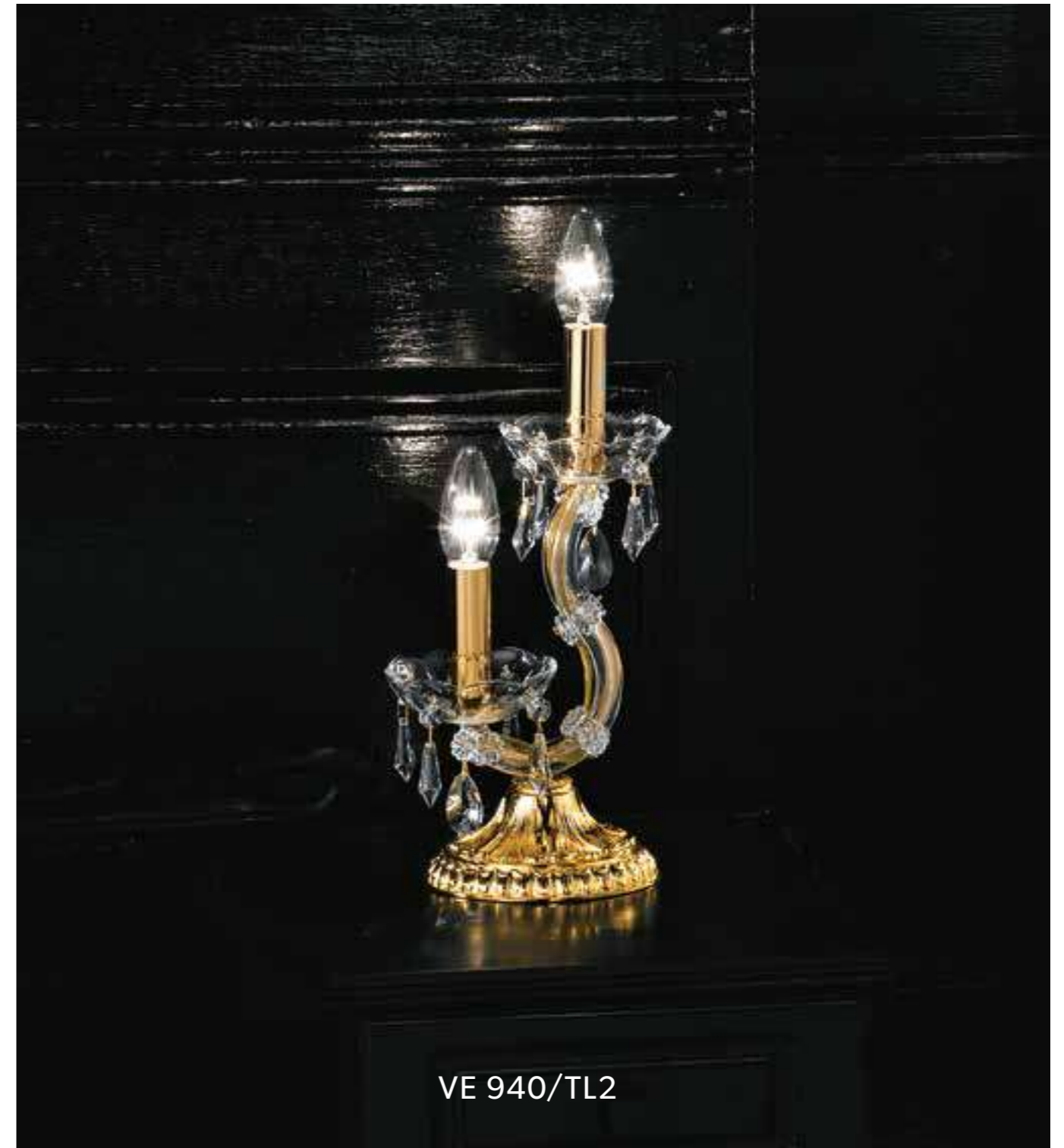
Ø 50 cm / 19.69"
H 65 cm / 25.59"

WW 5x E14x40 W max (not included)
USA 5x E12x40 W max (not included)

RW-DW 5x LED source - 20 W tot



VE 940/A5



VE 940/TL2

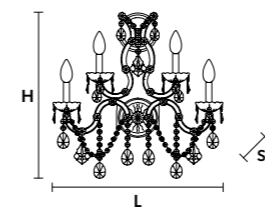
VE 940/A5



VE 940/TL1



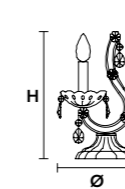
VE 940/TL2



L 35 cm / 13.77"
 SP 35 cm / 13.77"
 H 50 cm / 19.68"

WW 5×E14×40 W max (not included)
 USA 5×E12×40 W max (not included)

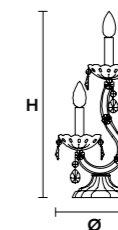
RW-DW 5×LED source -20 W tot



Ø 20 cm / 7.87"
 H 25 cm / 9.84"

WW 1×E14×40 W max (not included)
 USA 1×E12×40 W max (not included)

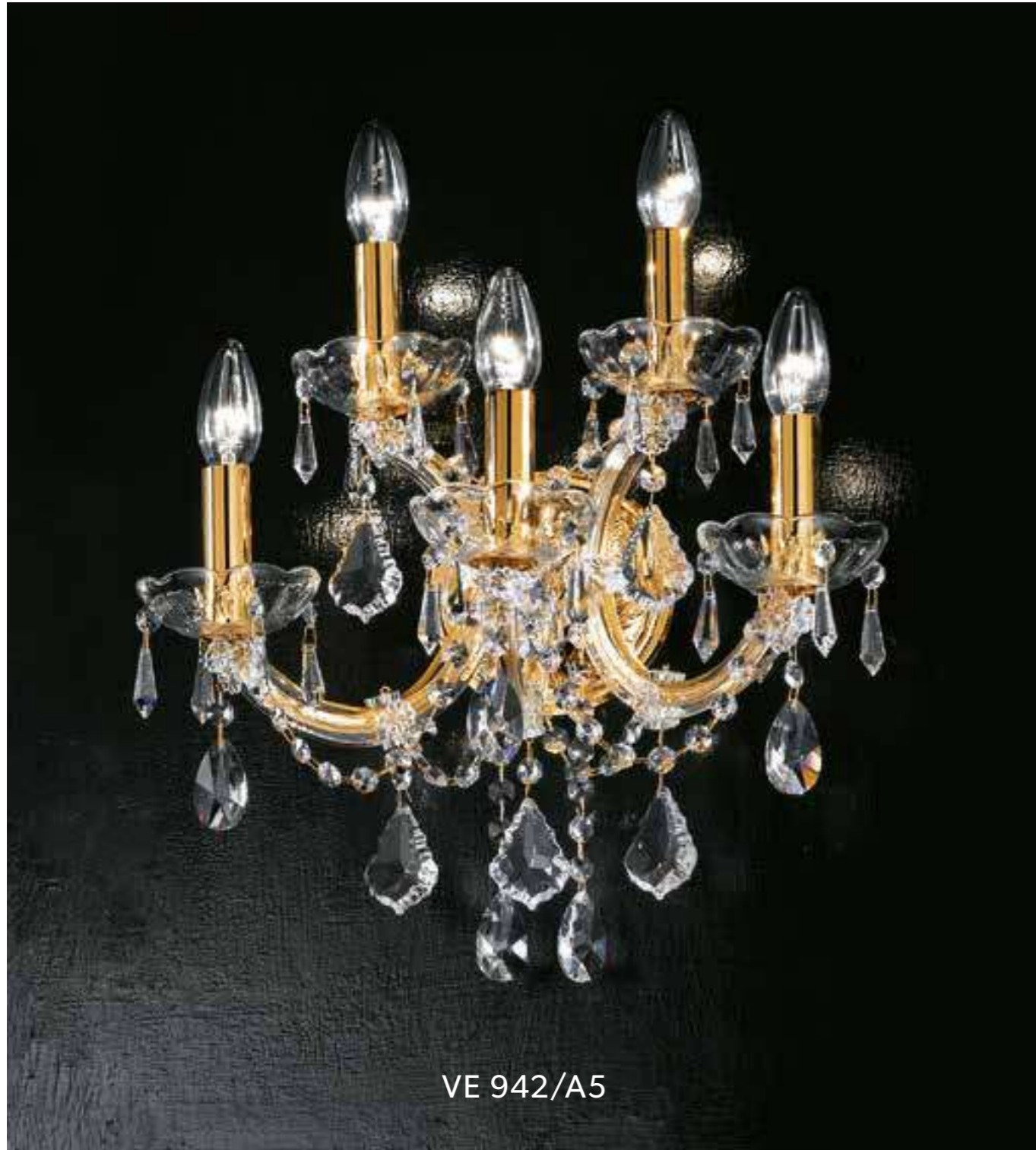
RW-DW 1×LED source -4 W tot



Ø 20 cm / 7.87"
 H 35 cm / 13.78"

WW 2×E14×40 W max (not included)
 USA 2×E12×40 W max (not included)

RW-DW 2×LED source -8 W tot

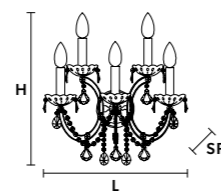


VE 942/A5



VE 942/STL5

VE 942/A5

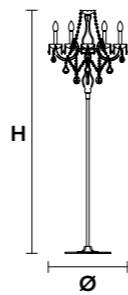


L 45 cm / 17.72"
 SP 25 cm / 9.84"
 H 40 cm / 15.75"

WW 5x E14x40 W max (not included)
 USA 5x E12x40 W max (not included)

RW-DW 5x LED source - 20 W tot

VE 942/STL5



Ø 55 cm / 21.65"
 H 185 cm / 72.83"

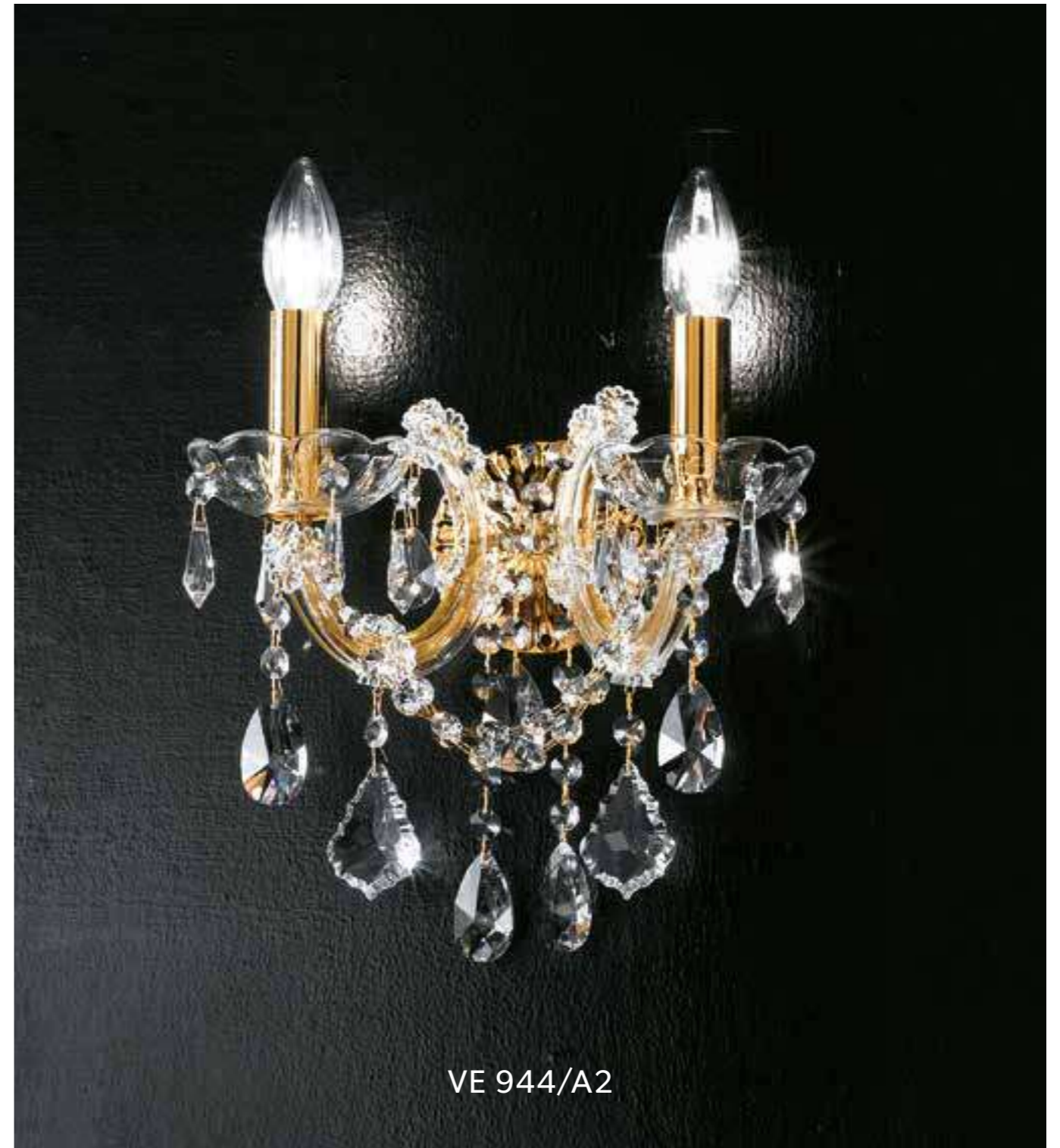
WW 5x E14x40 W max (not included)
 USA 5x E12x40 W max (not included)

RW-DW 5x LED source - 20 W tot




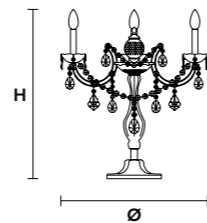
VE 944/TL3

VE 944/TL2




VE 944/A2

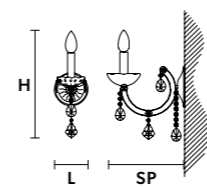
VE 944/TL3 



Ø 45 cm / 17.72"
H 60 cm / 23.62"


WW 3×E14×40 W max (not included)
USA 3×E12×40 W max (not included)
RW-DW 3×LED source - 12 W tot

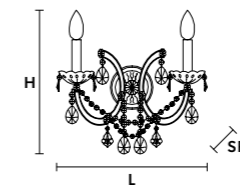
VE 944/A1 



L 12 cm / 4.72"
SP 20 cm / 7.87"
H 28 cm / 11.02"


WW 1×E14×40 W max (not included)
USA 1×E12×40 W max (not included)
RW-DW 1×LED source - 4 W tot

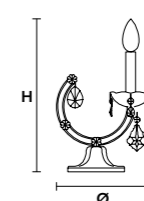
VE 944/A2 



L 28 cm / 11.02"
SP 20 cm / 7.87"
H 28 cm / 11.02"


WW 2×E14×40 W max (not included)
USA 2×E12×40 W max (not included)
RW-DW 2×LED source - 8 W tot

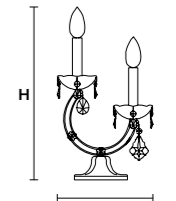
VE 944/TL1 



Ø 20 cm / 7.87"
H 28 cm / 11.02"

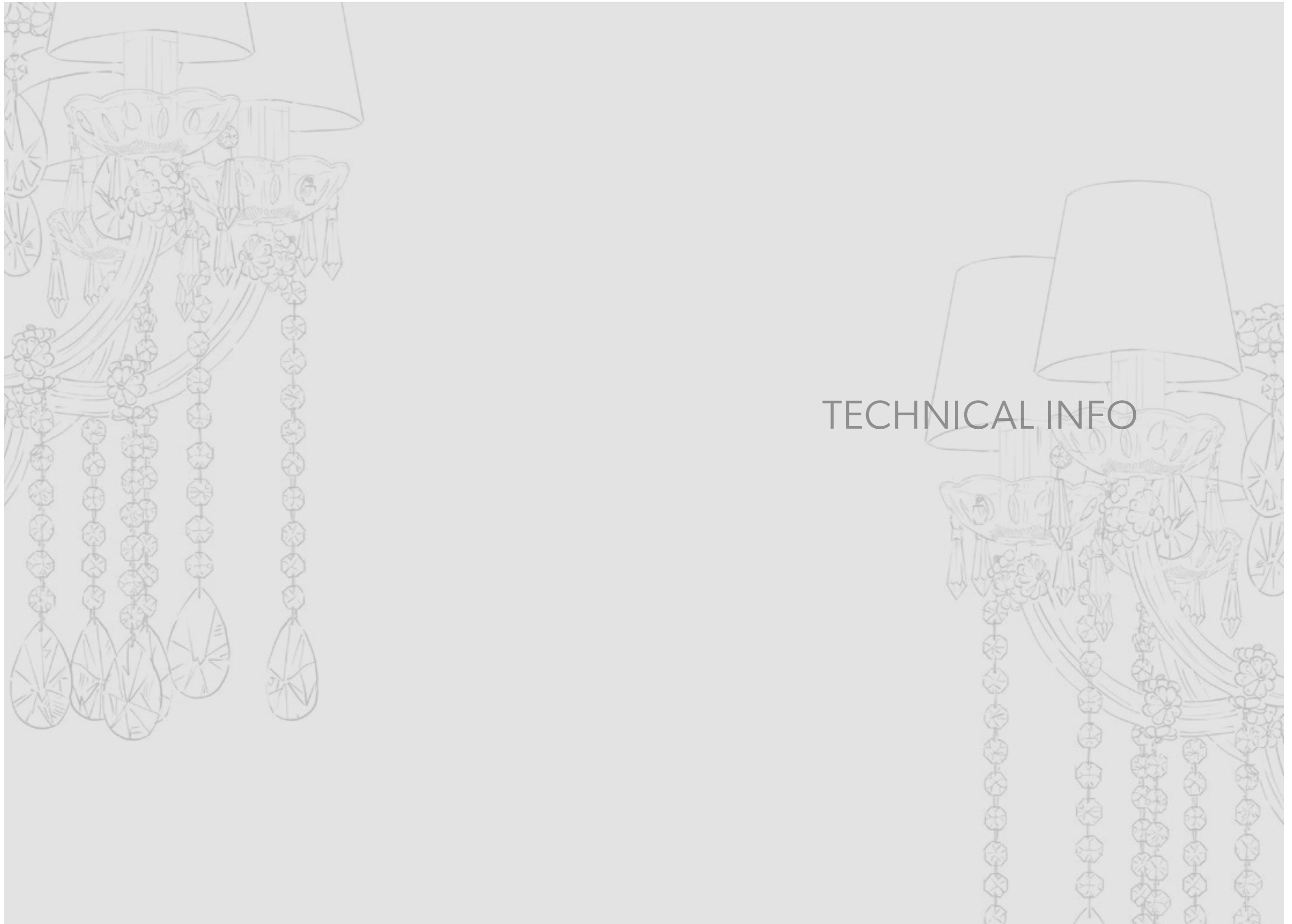
WW 1×E14×40 W max (not included)
USA 1×E12×40 W max (not included)
RW-DW 1×LED source - 4 W tot

VE 944/TL2 



Ø 20 cm / 7.87"
H 35 cm / 13.78"

WW 2×E14×40 W max (not included)
USA 2×E12×40 W max (not included)
RW-DW 2×LED source - 8 W tot



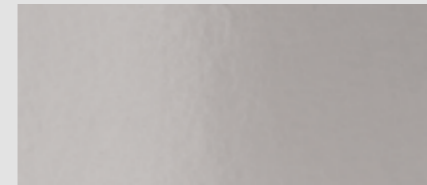
TECHNICAL INFO

FINITURE / FINISHING

Bagno galvanico / Galvanic Bath



G03 Oro lucido
Shiny gold



G04 Cromo lucido
Shiny chrome

Verniciati / Painted



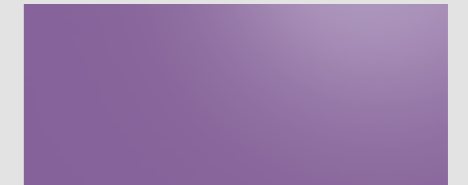
V31 Rosso lucido
Shiny red



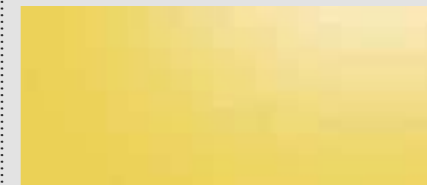
V42 Melanzana lucido
Shiny aubergine



V23 Arancio lucido
Shiny orange



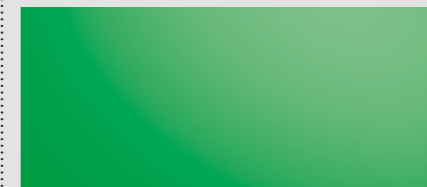
V41 Lilla lucido
Shiny lilac



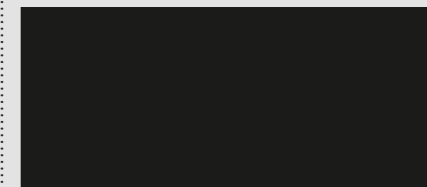
V22 Giallo lucido
Shiny yellow



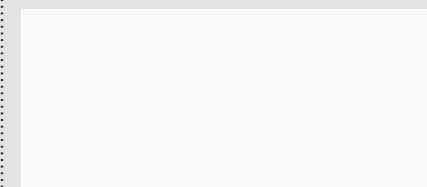
V53 Blu lucido
Shiny blue



V63 Verde lucido
Shiny green



V9L Nero lucido
Shiny black



V92 Bianco lucido
Shiny white

Verificare la disponibilità di ciascuna finitura per specifici articoli / Availability of each finish to be confirmed for specific items.

Indice/Index

ART.	LIGHTS	Ø/L-SP	H	PAG.
VE 901	70	260 cm	300 cm	97
VE 903	15	90 cm	70 cm	94
	24	150 cm	120 cm	94
	56	210 cm	180 cm	95
VE 905	15	90 cm	80 cm	46
	24	145 cm	120 cm	46
	56	210 cm	195 cm	47
VE 906	15	100 cm	78 cm	44
	32	125 cm	90 cm	44
	42	150 cm	180 cm	44
	49	190 cm	170 cm	45
VE 907	35	140 cm	210 cm	98
	65	170 cm	250 cm	99
VE 909	15	110 cm	110 cm	100
	30	144 cm	102 cm	101
	60	190 cm	145 cm	100
VE 910	25	100 cm	75 cm	52
	32	125 cm	90 cm	52
	42	150 cm	180 cm	52
	49	185 cm	165 cm	52
	56	185 cm	165 cm	53
VE 911	25	100 cm	160 cm	62
	32	125 cm	170 cm	62
	45	150 cm	270 cm	62
	56	185 cm	240 cm	63
	110	250 cm	400 cm	61
VE 913	12	110 cm	95 cm	102
	36	167 cm	98 cm	103
	46	205 cm	120 cm	102
VE 915	12	95 cm	82 cm	69
	36	170 cm	90 cm	68
	48	205 cm	140 cm	68
VE 917	15	85 cm	60 cm	83
VE 918	30	100 cm	90 cm	75
	48	165 cm	110 cm	74
	72	200 cm	160 cm	74
VE 919	PL10	90 cm	35 cm	120
	PL12	105 cm	35 cm	121
	PL20	130 cm	45 cm	120
VE 920	14	90 x 45 cm	50 cm	64
	24	160 x 70 cm	60 cm	65
	30	200 x 70 cm	60 cm	64
VE 921	24	150 x 85 cm	68 cm	31
	32	200 x 110 cm	65 cm	30
	A3+1	60 x 30 cm	40 cm	124
VE 923	13	80 cm	65 cm	105
	18	100 cm	65 cm	104
	21	125 cm	75 cm	104
VE 925	15	100 cm	80 cm	111
VE 927	12	85 cm	70 cm	106
	16	118 cm	84 cm	107
	24	118 cm	84 cm	106
	30	165 cm	105 cm	106
VE 929	24	120 cm	120 cm	55
	36	165 cm	160 cm	54
VE 931	12	100 cm	46 cm	77
VE 933	12	80 cm	65 cm	114
	15	80 cm	65 cm	114
	24	120 cm	110 cm	114
	50	160 cm	155 cm	115
VE 934	12	95 cm	80 cm	78
	40	150 cm	95 cm	79
VE 935	12	75 cm	60 cm	108
	18	120 cm	75 cm	108
	30	170 cm	85 cm	109
VE 937	A2	44 x 22 cm	36 cm	123
VE 938	A1	15 x 22 cm	40 cm	128
	A2	30 x 22 cm	50 cm	128
	STL5	50 cm	185 cm	129
	TL5	50 cm	65 cm	129

ART.	LIGHTS	Ø/L-SP	H	PAG.
VE 940	5	60 cm	50 cm	91
	8	62 cm	50 cm	90
	12	62 cm	57 cm	90
	18	105 cm	85 cm	90
	24	100 cm	70 cm	90
	A5	35 x 35 cm	50 cm	130
	TL1	20 cm	25 cm	131
	TL2	20 cm	35 cm	131
VE 942	A5	45 x 25 cm	40 cm	132
	STL5	55 cm	185 cm	133
VE 944	3	47 cm	42 cm	92
	5	47 cm	42 cm	93
	A1	12 x 20 cm	28 cm	135
	A2	28 x 20 cm	28 cm	135
	TL1	20 cm	28 cm	135
	TL2	20 cm	35 cm	134
	TL3	45 cm	60 cm	134
VE 945	18	107 x 65 cm	50 cm	24
	20	153 x 93 cm	66 cm	24
	24	129 x 88 cm	69 cm	24
	32	200 x 88 cm	80 cm	25
	46	192 x 114 cm	110 cm	24
VE 950	18	105 cm	65 cm	81
VE 951	15	105 cm	85 cm	112
	24	145 cm	125 cm	113
	40	200 cm	135 cm	112
VE 954	1	40 cm	50 cm	89
VE 956	1	40 cm	40 cm	87
VE 959	12	115 cm	95 cm	117
	30	155 cm	125 cm	116
	56	200 cm	140 cm	116
VE 961	8	75 cm	42 cm	29
	10	85 cm	42 cm	28
	12	75 cm	60 cm	28
	15	85 cm	60 cm	28
	24	150 cm	105 cm	28
VE 973	70	290 cm	300 cm	51
VE 975	16	110 cm	70 cm	85
VE 980	12	106 cm	70 cm	66
	24	140 cm	70 cm	67
	60	220 cm	75 cm	66
VE 981	12	106 cm	70 cm	57
	24	140 cm	70 cm	59
	60	220 cm	75 cm	58
VE 984	12	106 cm	70 cm	72
	24	140 cm	70 cm	72
	60	220 cm	75 cm	73
VE 986	15	95 cm	70 cm	40
	18	135 cm	90 cm	41
	39	190 cm	125 cm	40
	A3	50 x 25 cm	55 cm	125
VE 987	15	95 cm	130 cm	42
	18	140 cm	200 cm	43
	39	190 cm	210 cm	42
VE 988	32	130 cm	90 cm	70
	48	130 cm	90 cm	71
VE 989	15	95 cm	55 cm	119
	24	140 cm	80 cm	118
	36	165 cm	90 cm	118
VE 991	15	95 cm	65 cm	48
	24	140 cm	100 cm	49
	36	165 cm	95 cm	48
VE 992	18	85 cm	100 cm	35
	30	115 cm	140 cm	37
	48	120 cm	240 cm	39
	70	150 cm	380 cm	38
VE 996	15	95 cm	60 cm	26
	36	165 cm	95 cm	27
	48	210 cm	110 cm	26
	A4	48 x 27 cm	41 cm	126
VE 998	18	125 cm	130 cm	33
	40	170 cm	120 cm	32
	56	215 cm	120 cm	32
	A5	42 x 32 cm	53 cm	127

CE

Attesta la conformità del prodotto alle disposizioni delle Direttive comunitarie.

It certifies the conformity of the products to the European Community provisions.

Il atteste la conformité du produit aux dispositions des directives communitaires.

Konformität des Produktes mit den Richtlinien der europäischen Gemeinschaft.

НАСТОЯЩИМ ПОДТВЕРЖДАЕТСЯ СООТВЕТСТВИЕ ПРОДУКЦИИ ПОЛОЖЕНИЯМ ДИРЕКТИВ ЕС.

Certifica la conformidad del producto según las disposiciones de las directivas comunitarias.

CE标记是指产品的制造商证明该产品符合适用的EC指令的所有基本要求。

يُشهد بمطابقة المنتج لأحكام توجيهات المجتمع الأوروبي.



Il logo "ETL" si riferisce agli articoli che possono essere modificati con componenti certificati ETL. L'elenco degli articoli ETL si riferisce a prodotti testati e valutati in base agli standard di sicurezza del mercato statunitense. Per il mercato USA fare riferimento al listino dedicato.

"ETL" logos refers to articles which can be modified with ETL- compliance components. The "ETL" listing articles stands for tested and evaluated product to recognised US safety standards. For the US market, refer to the relevant price list.

"ETL" logo se réfère aux articles qui peuvent être modifiées par des composants certifiés ETL. la liste des articles ETL se réfère à des produits testés et évalués selon les normes de sécurité du marché américain. Pour le marché américain se référer à la liste des prix.

Das "ETL"-Logo bezieht sich auf Artikel, die mit ETL-zertifizierten Komponenten modifiziert werden können. Die Liste der ETL-Artikel bezieht sich auf Produkte, die nach den Sicherheitsstandards des US-Marktes getestet und bewertet wurden. Für den US-Markt beachten Sie bitte die entsprechende Preisliste.

ЛОГОТИП «ETL» ОТНОСИТСЯ К ЭЛЕМЕНТАМ, КОТОРЫЕ МОГУТ БЫТЬ МОДИФИЦИРОВАННЫ С ПОМОЩЬЮ СЕРТИФИЦИРОВАННЫХ ETL КОМПОНЕНТОВ. СПИСОК ЭЛЕМЕНТОВ ETL ОТНОСИТСЯ К ПРОДУКЦИИ, ПРОТЕСТИРОВАННОЙ И ОЦЕНЕННОЙ В СООТВЕТСТВИИ С ПРИЗНАННЫМИ СТАНДАРТАМИ БЕЗОПАСНОСТИ США. ДЛЯ ПОТРЕБИТЕЛЕЙ НАХОДЯЩИХСЯ В США СМ. СООТВЕТСТВУЮЩИЙ ПРАЙС-ЛИСТ.

El logo "ETL" indica los artículos, que pueden modificarse con componentes certificados ETL. La lista de los artículos ETL se refiere a los productos sometidos a prueba y evaluados en función de los estándares de seguridad del mercado estadounidense. Consultar la lista de precios específica para el mercado de los Estados Unidos.

"ETL" 徽标是指可以使用ETL认证的组件进行修改的项目。 ETL项目列表是指根据美国市场的安全标准进行测试和评估的产品。 对于美国市场, 请参考美国市场价格表。

يشير شعار «ETL» إلى المنتجات التي يمكن تعديلها باستخدام مكونات مُعتمدة من ETL. تشير قائمة منتجات ETL إلى المنتجات التي تم اختبارها وتقييمها وفقًا لمعايير السلامة في السوق الأمريكي. بالنسبة لسوق الولايات المتحدة الأمريكية، يُرجى الرجوع إلى قائمة الأسعار المُخصصة.

Im

Flusso luminoso nominale. L'indicazione si riferisce al valore in assenza di rifrazione, come dichiarato dal produttore del componente.

Nominal luminous flux. It refers to the value without any refraction, as declared by the component manufacturer.

L'unité SI de flux lumineux. L'indication correspond à la valeur en l'absence de réfraction, comme indiqué par le fabricant du composant.

Die Maßeinheit für den Lichtstrom. Die Angabe bezieht sich auf den Wert in der Abwesenheit von Brechung, wie vom Hersteller der Komponente angegeben.

НОМИНАЛЬНЫЙ СВЕТОВОЙ ПОТОК. УКАЗАНИЕ ОТНОСИТСЯ К ЗНАЧЕНИЮ В ОТСУТСТВИЕ РЕФРАКЦИИ, КАК ЗАЯВЛЕНО ПРОИЗВОДИТЕЛЕМ КОМПОНЕНТОВ.

Flujo luminoso nominal. La indicación se refiere al valor sin refracción, como declarado por el fabricante del componente.

标称光通量。指示是指组件制造商声明的没有折射的值。

التدفق الضوئي الاسمي. يشير المؤشر إلى القيمة في حالة عدم وجود انكسار للضوء، كما هو مُعلن من قبل الشركة المصنعة للعنصر.

MASIERO

Masiero si riserva il diritto di apportare ai propri articoli, senza nessun preavviso, qualsiasi modifica ritenesse opportuna.

Masiero reserves the right to introduce any changes to its own products, without notice in advance.

Masiero se réserve le droit d'apporter une quelconque modification à les modèles sans préavis.

Masiero behält sich das Recht vor Änderungen vorzunehmen, ohne sofortige Benachrichtigung.

КОМПАНИЯ MASIERO ОСТАВЛЯЕТ ЗА СОБОЙ ПРАВО БЕЗ ПРЕДВАРИТЕЛЬНОГО УВЕДОМЛЕНИЯ, ЕСЛИ ЭТО БУДЕТ СОЧТЕНО ЦЕЛЕСООБРАЗНЫМ, ВНОСИТЬ В СОБСТВЕННЫЕ МОДЕЛИ ЛЮБЫЕ ИЗМЕНЕНИЯ.

Masiero se reserva el derecho de aportar modificaciones consideradas oportunas a sus artículos sin preaviso.

Masiero 保留对其认为适当的任何更改的权利, 恕不另行通知。

تحتفظ شركة مازيرو "Masiero" بالحق في إجراء أي تعديلات تراها مناسبة على منتجاتها، دون إشعار مسبق.

Masiero srl

via Peschiere, 53
31032 Casale sul Sile
Treviso, Italy
T +39 0422 7861
F +39 0422 786250

info@masierogroup.com
masierogroup.com

Design by Masiero
Photo, Studio Pointer
Print Italy, April 2021
by Grafica Antiga

The background is a solid teal color with a faint, light-colored line drawing of a classical column. The column is positioned on the right side of the page, extending from the top to the bottom. It features a capital with acanthus leaves and a shaft with a repeating circular pattern.

IMPERO&DECO
ATELIER

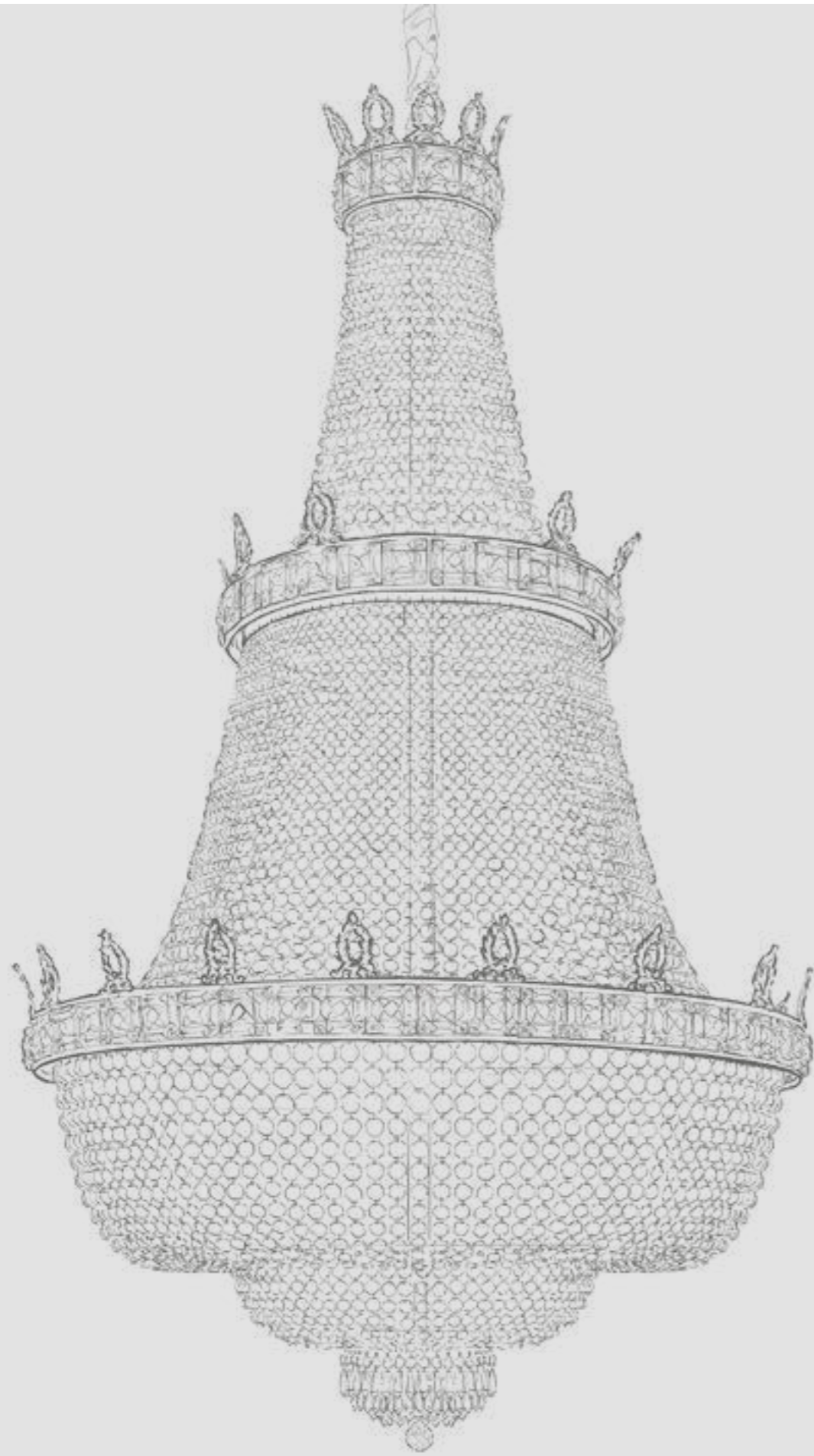
MASIERO



IMPERO&DECO

ATELIER

MASIERO



IMPERO&DECO

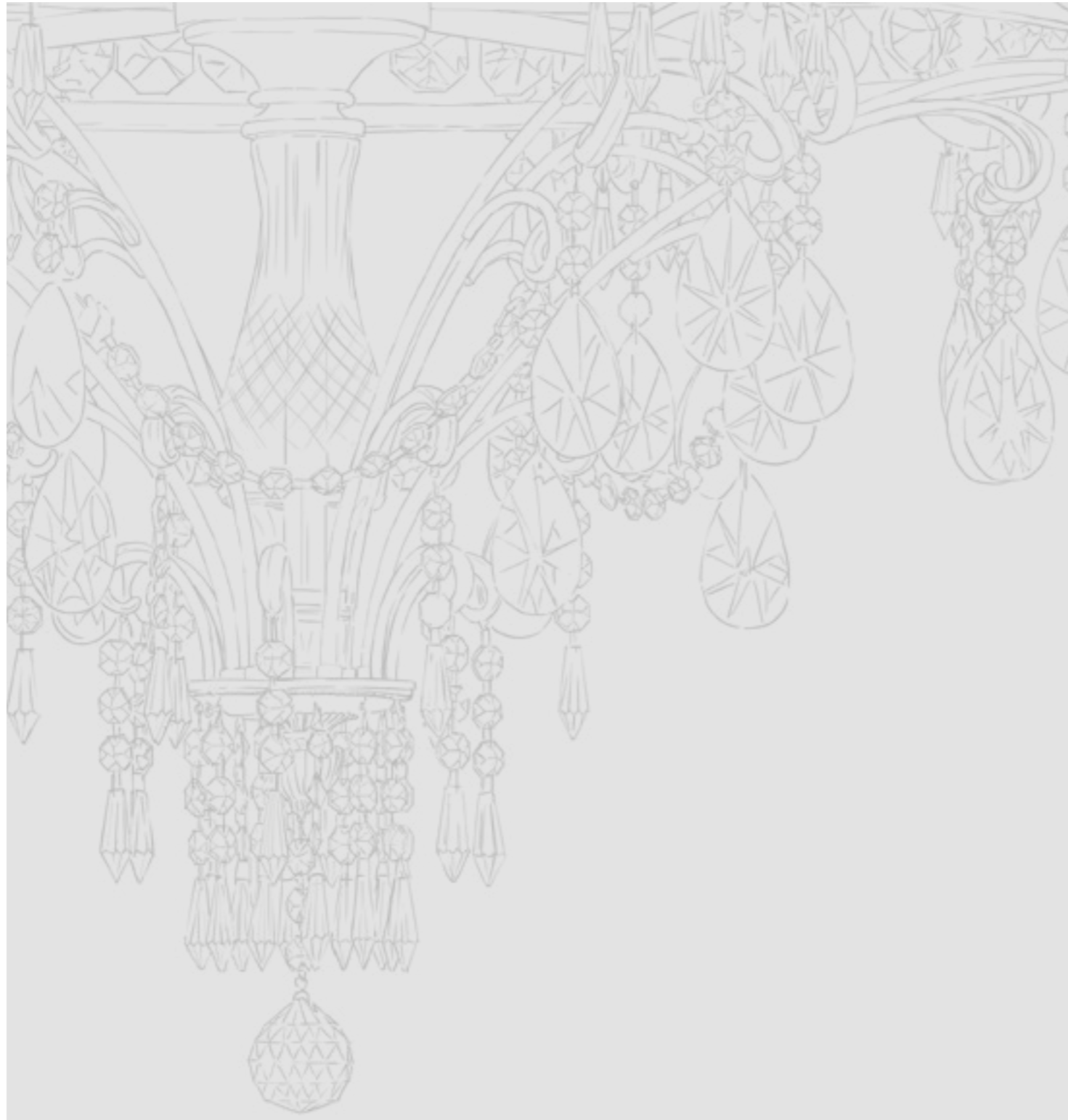
L'eleganza inconfondibile di un lusso contemporaneo che prende ispirazione dal gusto rinascimentale, per evolversi in un classico senza tempo.


Cadute di cristallo di varie forme e dimensioni riflettono la luce, moltiplicandola all'infinito.

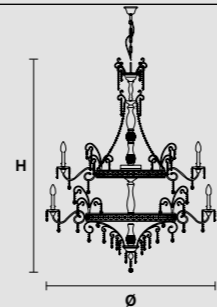
Lampadari unici che ricordano una nobile storia, celebrando il bello di un oggetto d'arte.

The unmistakable elegance of a contemporary luxury that takes its inspiration from Renaissance taste and evolves it into a timeless classic.

Crystal pendants in various shapes and sizes reflect the light and multiply it to infinity. Unique chandeliers revive the noblest history and celebrate the true beauty of a piece of art.



VE 802/12+6 

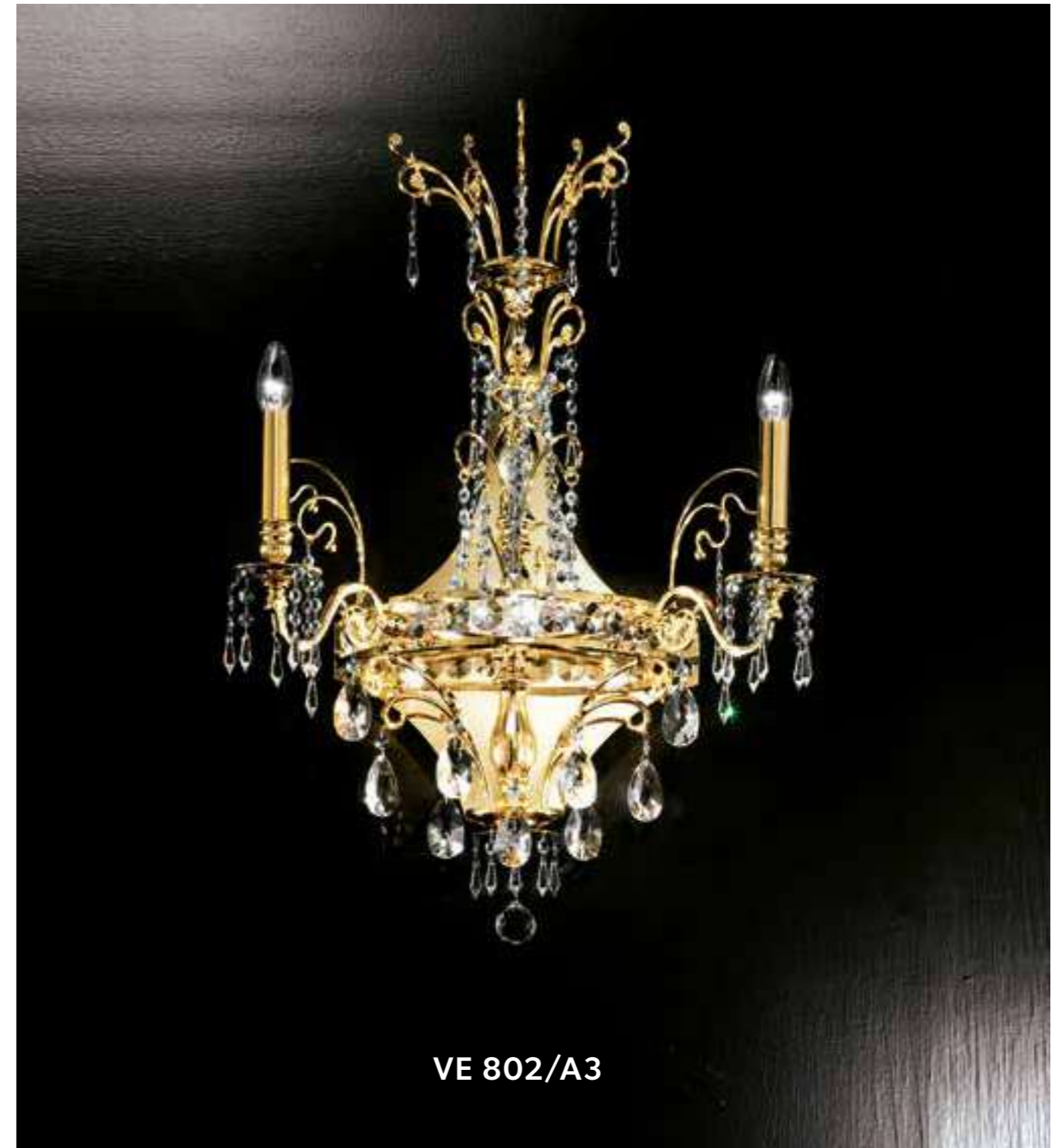


Ø 110 cm / 43.31"
 H 150 cm / 59.06"
 W 26 kg / 57.32 lb

WW 18×E14×40 W max (not included)
 USA 18×E12×40 W max (not included)



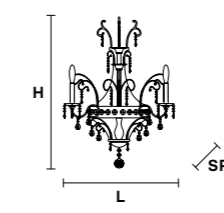
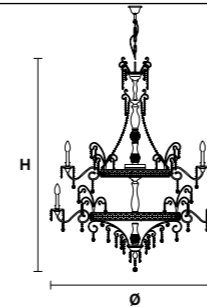
VE 802/12+6



VE 802/12+6



VE 802/A3




Ø 110 cm / 43.31"
 H 150 cm / 59.06"
 W 26 kg / 57.32 lb

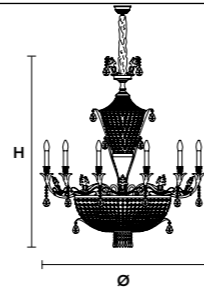
L 60 cm / 23.62"
 SP 32 cm / 12.60"
 H 90 cm / 35.43"
 W 7 kg / 15.43 lb

WW 18×E14×40 W max (not included)
 USA 18×E12×40 W max (not included)

WW 3×E14×40 W max (not included)
 USA 3×E12×40 W max (not included)



VE 803/13+6 



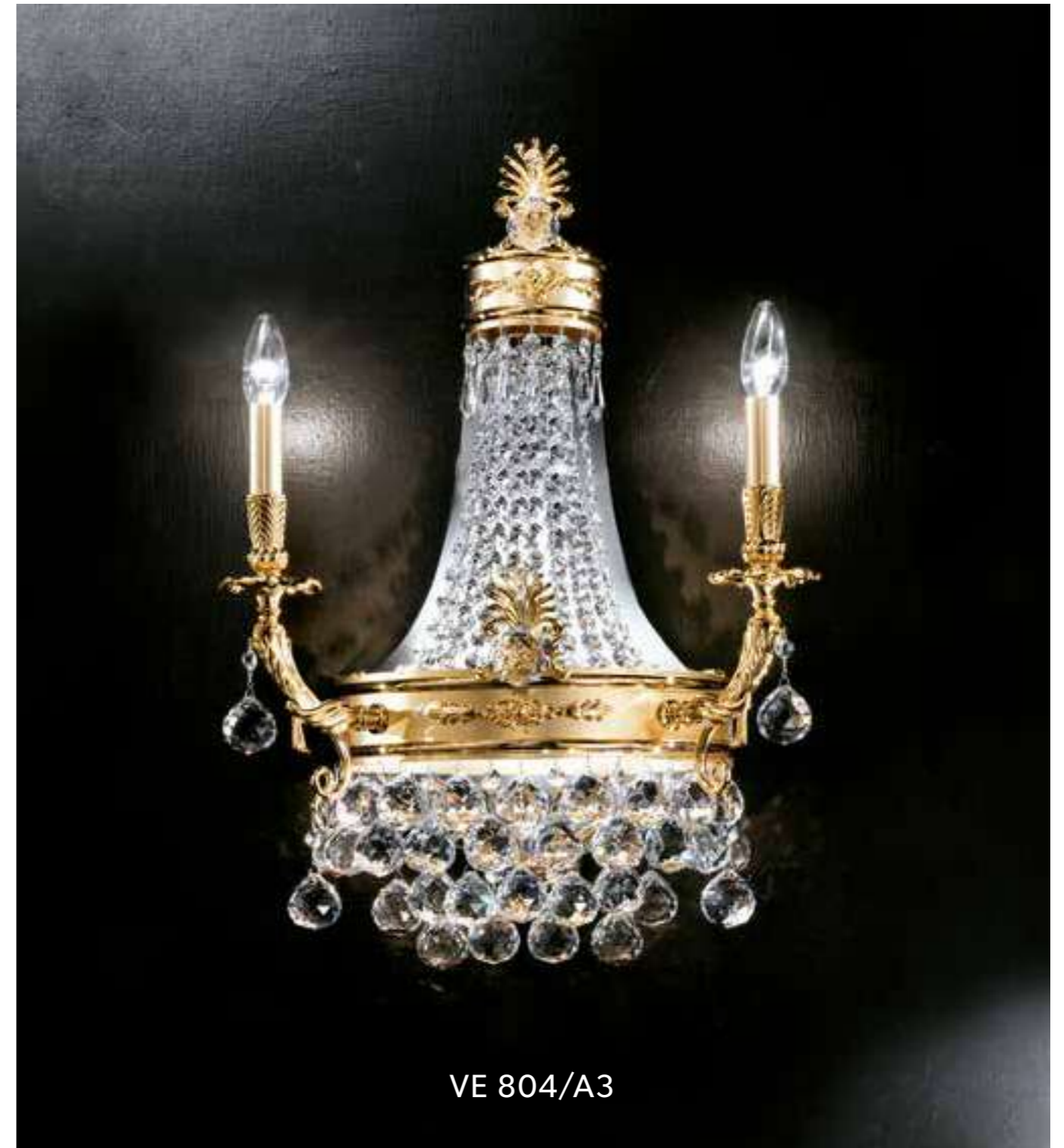
Ø 100 cm / 39.37"
 H 130 cm / 51.18"
 W 35 kg / 77.16 lb

WW 13xE14x40 W max (not included)
 6xE27x60 W max (not included)
 USA 13xE12x40 W max (not included)
 6xE26x60 W max (not included)

VE 803/13+6

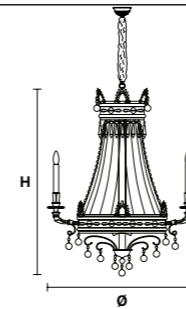


VE 804/6+3+3



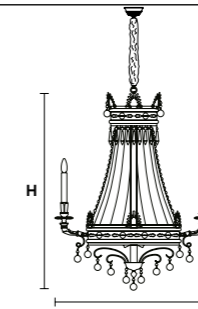
VE 804/A3

VE 804/6+3+3 CE VE 804/8 + 4 + 4 CE VE 804 / A3 CE



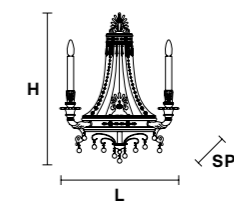
Ø 60 cm / 23.60"
H 100 cm / 39.37"
W 37 kg / 81.57 lb

WW 12×E14×40 W max (not included)
USA 12×E12×40 W max (not included)



Ø 90 cm / 35.40"
H 120 cm / 47.20"
W 45 kg / 99.00 lb


WW 16×E14×40 W max (not included)
USA 16×E12×40 W max (not included)

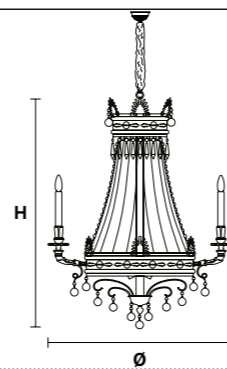


L 45 cm / 17.72"
SP 25 cm / 9.84"
H 60 cm / 23.62"
W 9 kg / 19.84 lb

WW 3×E14×40 W max (not included)
USA 3×E12×40 W max (not included)



VE 804/20 CE 

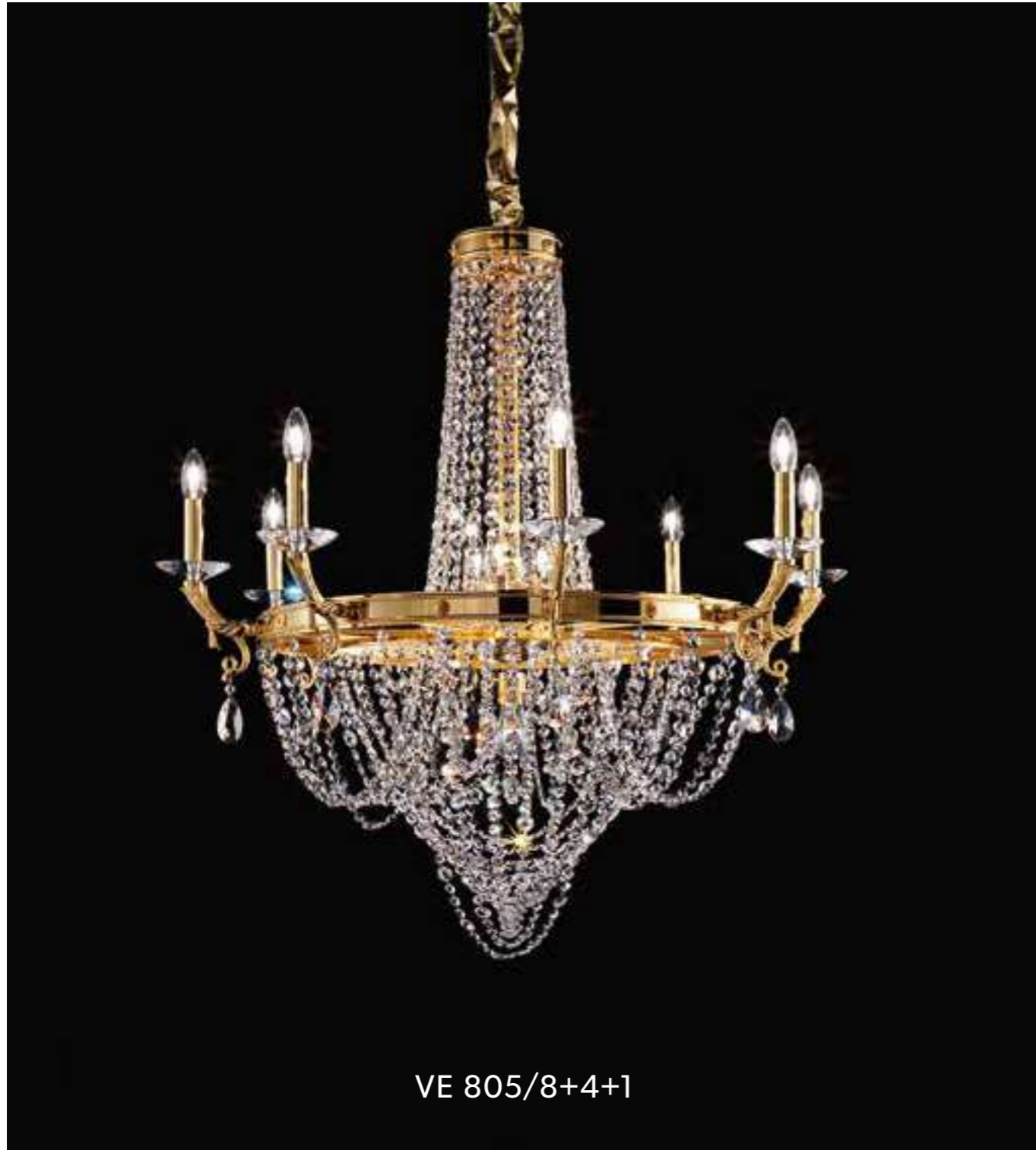


Ø 120 cm / 47.24"
 H 150 cm / 59.06"
 W 58 kg / 127.86 lb


WW 20×E14×40 W max (not included)
 USA 20×E12×40 W max (not included)

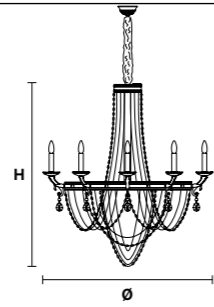


VE 804/20




VE 805/8+4+1

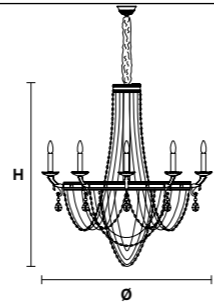
VE 805/8+4+1 



Ø 100 cm / 39.37"
 H 100 cm / 39.37"
 W 26 kg / 57.32 lb

WW 12×E14×40 W max (not included)
 1×E27×60 W max (not included)
 USA 12×E12×40 W max (not included)
 1×E26×60 W max (not included)

VE 805/12+6+1 



Ø 140 cm / 55.15"
 H 150 cm / 59.10"
 W 40 kg / 88.18 lb

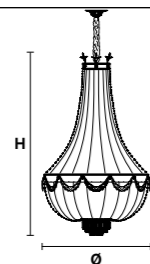
WW 18×E14×40 W max (not included)
 1×E27×60 W max (not included)
 USA 18×E12×40 W max (not included)
 1×E26×60 W max (not included)



VE 805/12+6+1

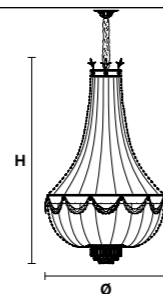


VE 818/12 VE 818/16 VE 818/18



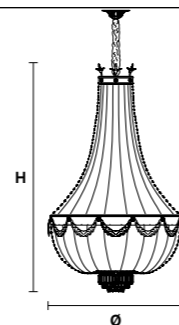
Ø 60 cm / 23.62"
H 100 cm / 39.37"
W 20 kg / 44.09 lb

WW 12×E27×60 W max (not included)
USA 12×E26×60 W max (not included)



Ø 78 cm / 30.71"
H 140 cm / 55.12"
W 30 kg / 66.13 lb

WW 16×E27×60 W max (not included)
USA 16×E26×60 W max (not included)



Ø 100 cm / 39.37"
H 165 cm / 64.96"
W 55 kg / 121.25 lb

WW 18×E27×60 W max (not included)
USA 18×E26×60 W max (not included)

VE 818/18

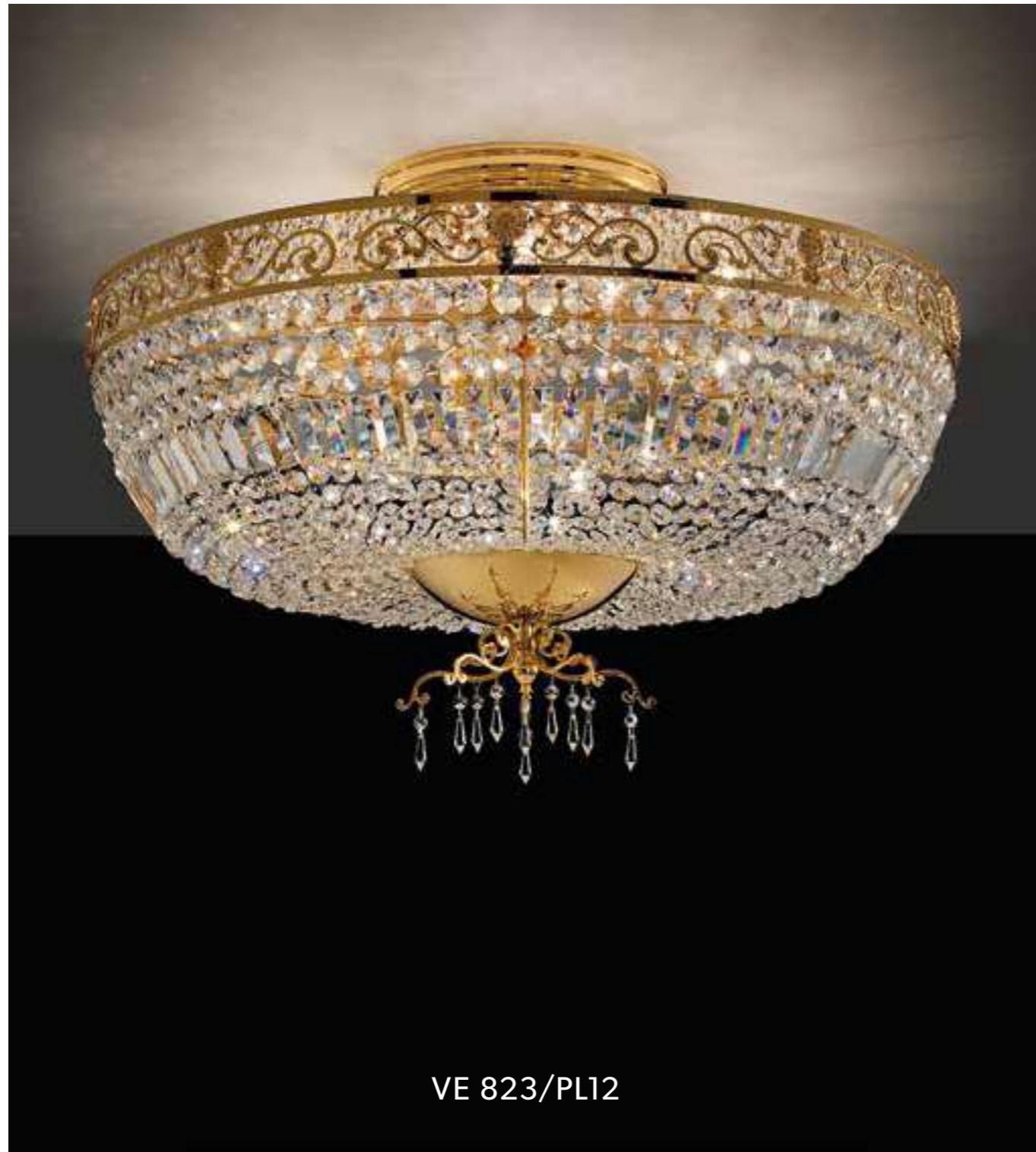


VE 818/PL18




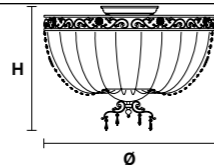
VE 818/A3

VE 818/PL12	VE 818/PL16	VE 818/PL18	VE 818/A3
<p>Ø 60 cm / 23.62"</p> <p>H 45 cm / 17.72"</p> <p>W 18 kg / 39.68 lb</p>	<p>Ø 78 cm / 30.71"</p> <p>H 60 cm / 23.62"</p> <p>W 27 kg / 59.52 lb</p>	<p>Ø 100 cm / 39.37"</p> <p>H 70 cm / 27.55"</p> <p>W 45 kg / 99.20 lb</p>	<p>L 32 cm / 12.60"</p> <p>SP 19 cm / 7.48"</p> <p>H 70 cm / 27.56"</p> <p>W 6 kg / 13.22 lb</p>
<p>WW 12×E27×60 W max (not included)</p> <p>USA 12×E26×60 W max x (not included)</p>	<p>WW 16×E27×60 W max (not included)</p> <p>USA 16×E26×60 W max (not included)</p>	<p>WW 18×E27×60 W max (not included)</p> <p>USA 18×E26×60 W max (not included)</p>	<p>WW 3×E14×40 W max (not included)</p> <p>USA 3×E12×40 W max (not included)</p>




VE 823/PL12

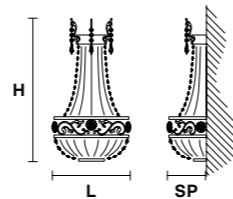
VE 823/PL12 



Ø 90 cm / 35.43"
H 60 cm / 23.62"
W 30 kg / 66.13 lb

WW 12×E27×60 W max (not included)
USA 12×E26×60 W max (not included)

VE 823/A3 




L 30 cm / 11.81"
SP 15 cm / 5.91"
H 55 cm / 21.65"
W 7 kg / 15.43 lb

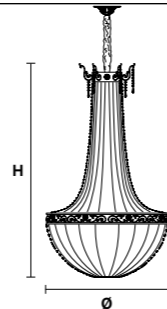
WW 3×E14×40 W max (not included)
USA 3×E12×40 W max (not included)



VE 823/A3



VE 823/20 



- Ø 90 cm / 35.43"
- H 160 cm / 62.99"
- W 48 kg / 105.82 lb

WW 20×E27×60 W max (not included)
 USA 20×E26×60 W max (not included)


VE 823/20

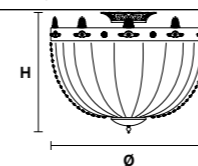


VE 827/PL10




VE 827/A4

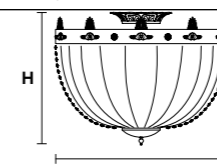
VE 827/PL8 



Ø 70 cm / 27.56"
H 55 cm / 21.65"
W 18 kg / 39.68 lb

WW 8×E27×60 W max (not included)
USA 8×E26×60 W max (not included)

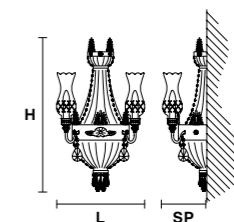
VE 827/PL10 



Ø 90 cm / 35.43"
H 70 cm / 27.56"
W 23 kg / 50.70 lb

WW 10×E27×60 W max (not included)
USA 10×E26×60 W max (not included)


VE 827/A4 

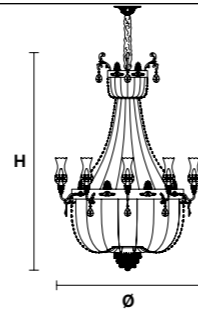


L 45 cm / 17.72"
SP 20 cm / 7.87"
H 70 cm / 27.56"
W 8 kg / 17.63 lb

WW 4×E14×40 W max (not included)
USA 4×E12×40 W max (not included)



VE 827/20 



Ø 116 cm / 45.67"
 H 160 cm / 62.99"
 W 47 kg / 103.61 lb

WW 10×E27×60 W max (not included)
 10×E14×40 W max (not included)
 USA 10×E26×60 W max (not included)
 10×E12×40 W max (not included)

VE 827/20

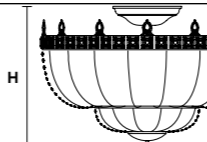
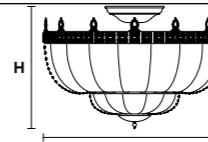
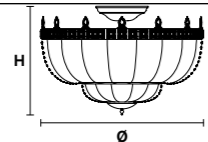
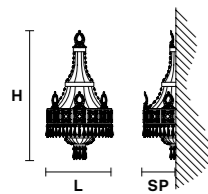


VE 829/A3



VE 829/PL12

VE 829/A3 VE 829/PL6 VE 829/PL8 VE 829/PL12



L 35 cm / 13.78"
SP 18 cm / 7.09"
H 62 cm / 24.41"
W 5 kg / 11.02 lb

WW 3×E14×40 W max (not included)
USA 3×E12×40 W max (not included)

Ø 60 cm / 23.62"
H 40 cm / 15.75"
W 18 kg / 39.68 lb

WW 6×E27×60 W max (not included)
USA 6×E26×60 W max (not included)

Ø 80 cm / 31.50"
H 50 cm / 19.69"
W 24 kg / 52.91 lb

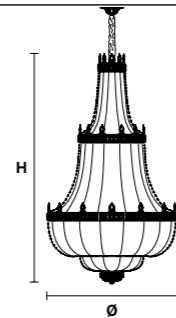
WW 8×E27×60 W max (not included)
USA 8×E26×60 W max (not included)

Ø 115 cm / 45.28"
H 70 cm / 27.56"
W 32 kg / 70.54 lb

WW 12×E27×60 W max (not included)
USA 12×E26×60 W max (not included)

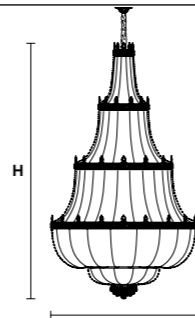


VE 829/22 CE Ⓜ VE 829/66 CE Ⓜ



Ø 115 cm / 45.28"
H 190 cm / 74.80"
W 58 kg / 127.8 lb

WW 22×E27×60 W max (not included)
USA 22×E26×60 W max (not included)

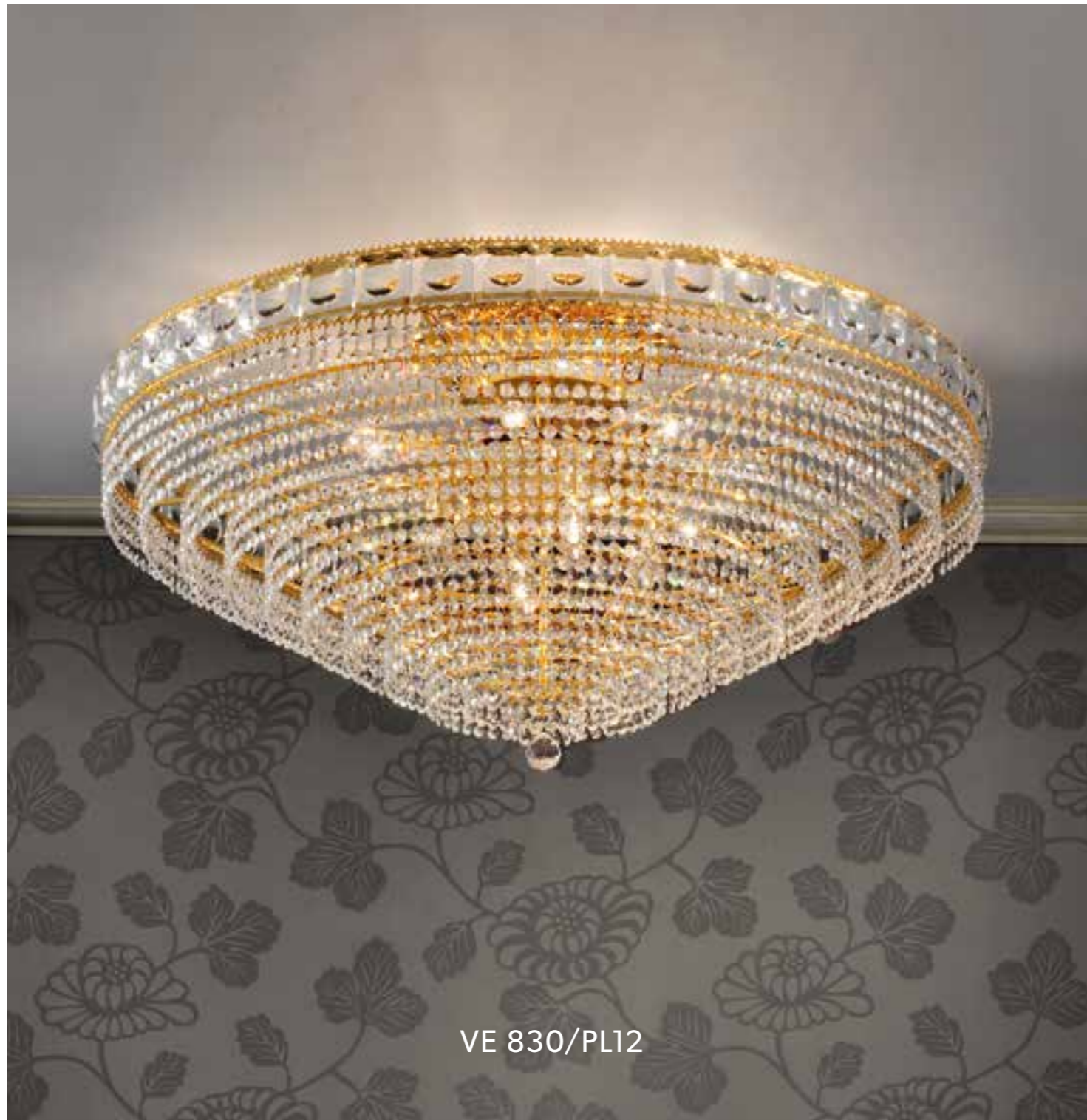


Ø 180 cm / 70.87"
H 300 cm / 118.11"
W 120 kg / 264.5 lb

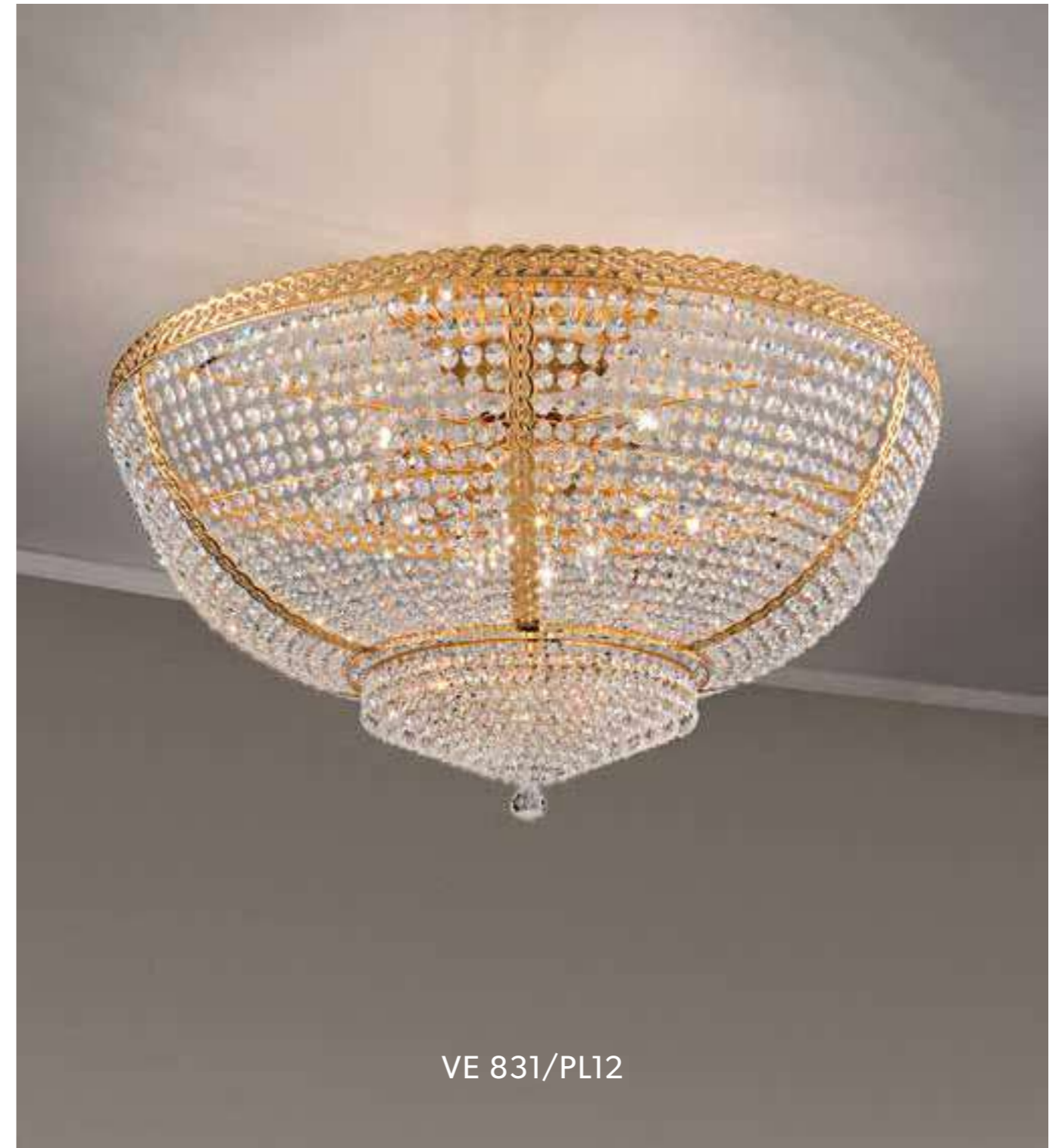
WW 66×E27×60 W max (not included)
USA 66×E26×60 W max (not included)



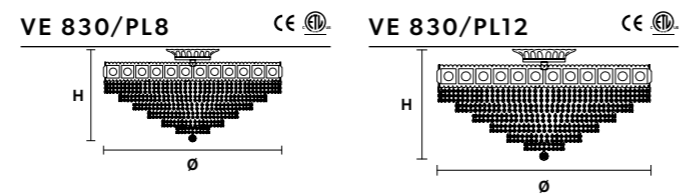
VE 829/22





VE 830/PL12





VE 831/PL12

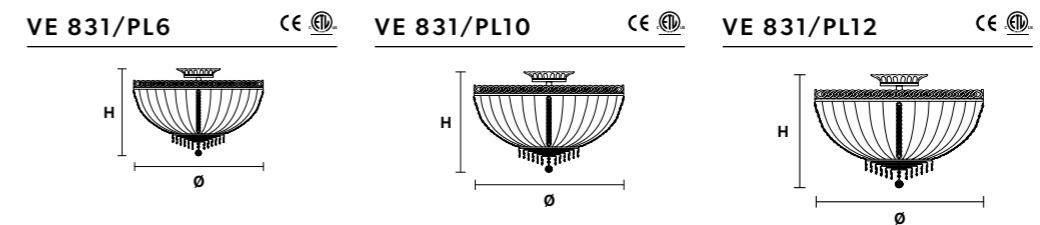




VE 830/PL8  
Ø 70 cm / 27.56"
H 40 cm / 15.75"
W 18 kg / 39.68 lb

WW 8×E14×40 W max (not included)
USA 8×E12×40 W max (not included)



VE 830/PL12  
Ø 100 cm / 39.37"
H 50 cm / 19.69"
W 28 kg / 61.72 lb

WW 12×E14×40 W max (not included)
USA 12×E12×40 W max (not included)





VE 831/PL6  
Ø 45 cm / 17.72"
H 40 cm / 15.75"
W 15 kg / 33.06 lb

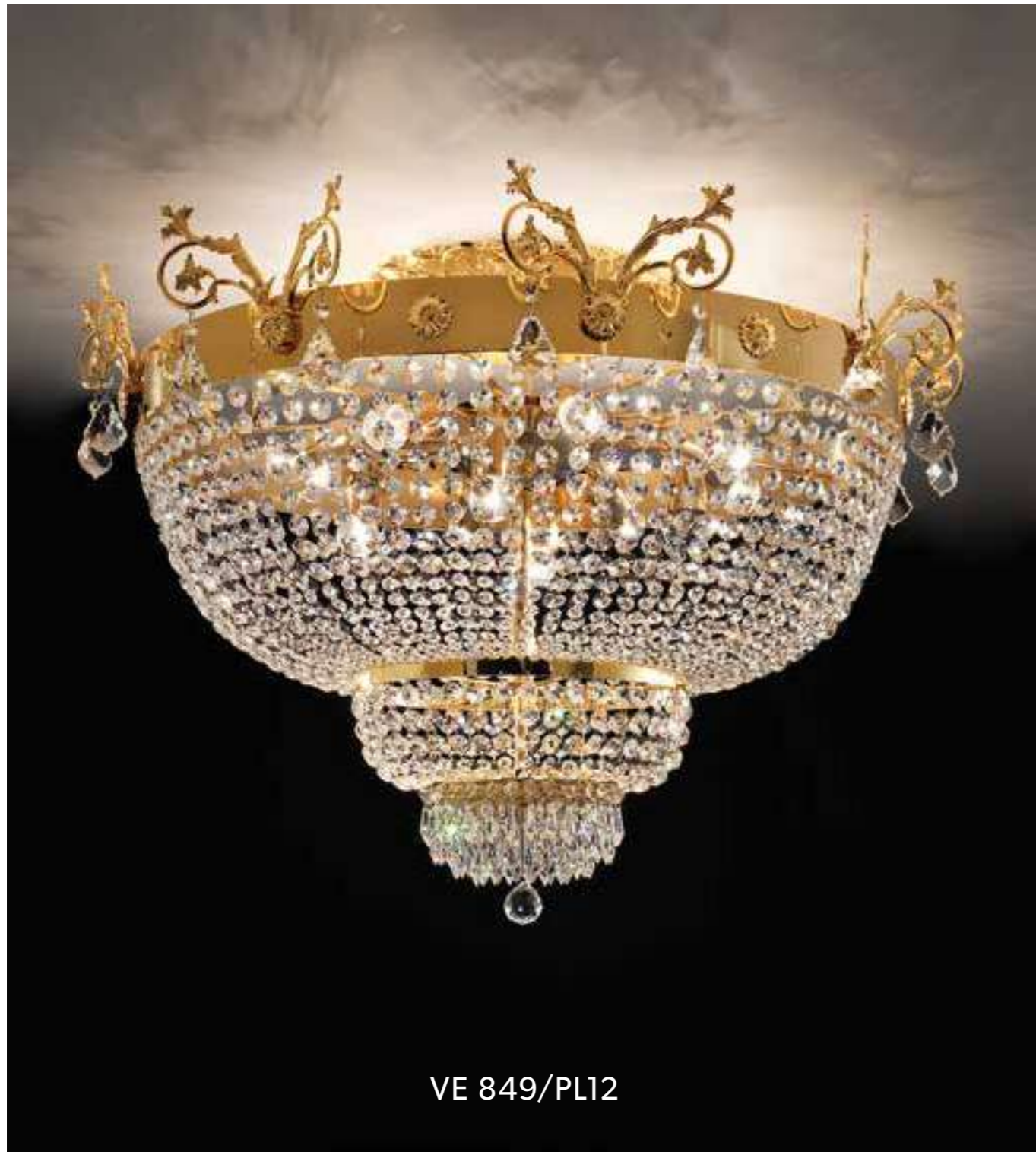
WW 6×E14×40 W max (not included)
USA 6×E12×40 W max (not included)

VE 831/PL10  
Ø 80 cm / 31.50"
H 50 cm / 19.69"
W 20 kg / 44.09 lb

WW 10×E14×40 W max (not included)
USA 10×E12×40 W max (not included)

VE 831/PL12  
Ø 100 cm / 39.37"
H 55 cm / 21.65"
W 26 kg / 57.32 lb

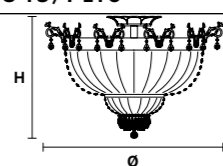
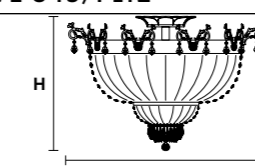
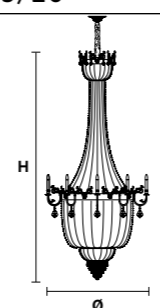
WW 12×E14×40 W max (not included)
USA 12×E12×40 W max (not included)

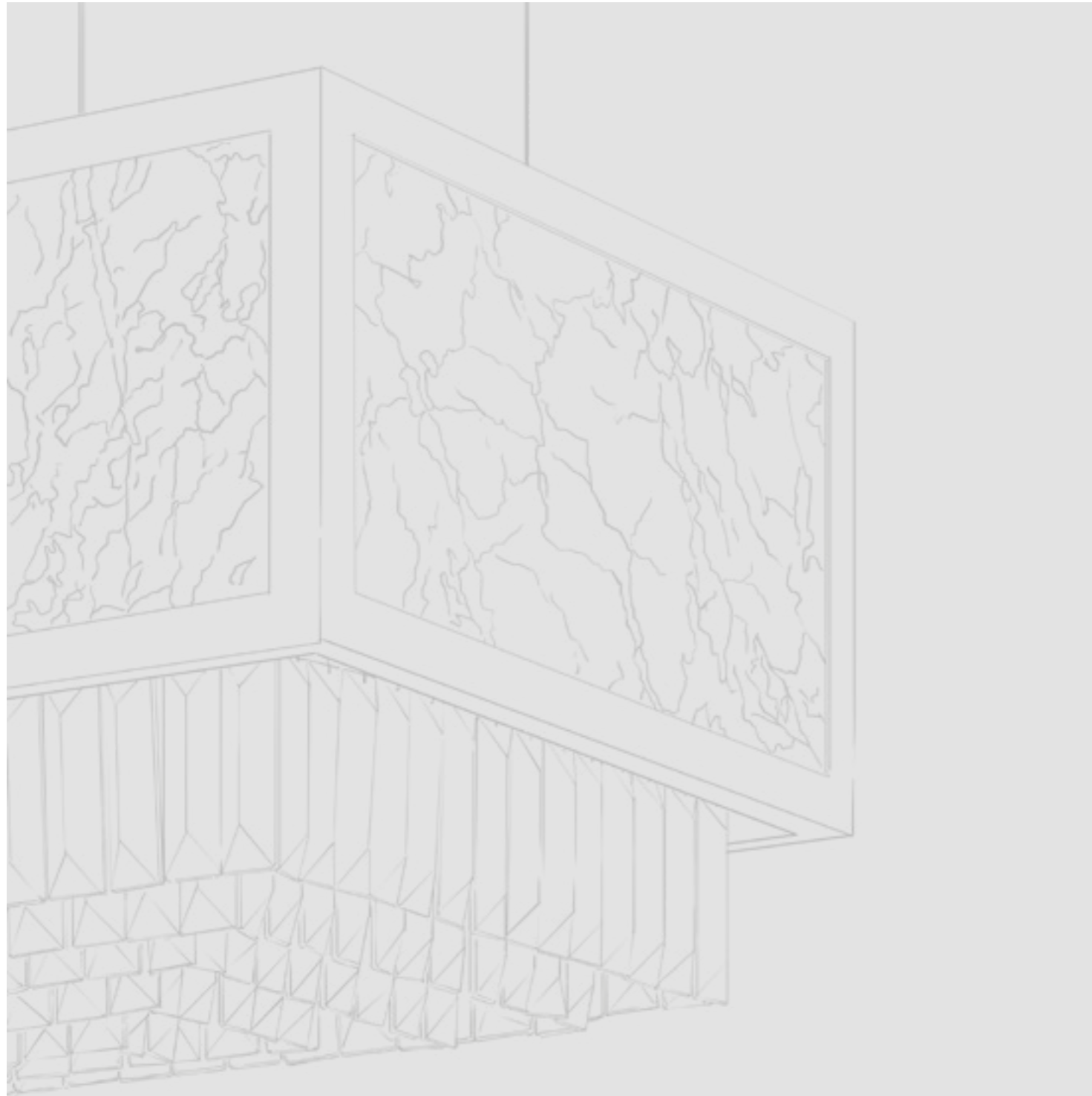


VE 849/PL12

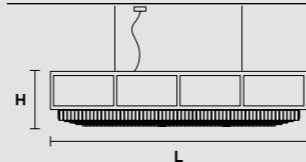


VE 849/26

VE 849/PL10	VE 849/PL12	VE 849/26
		
<p>Ø 70 cm / 27.56"</p> <p>H 55 cm / 21.65"</p> <p>W 18 kg / 39.68 lb</p>	<p>Ø 95 cm / 37.40"</p> <p>H 70 cm / 27.56"</p> <p>W 28 kg / 61.72 lb</p>	<p>Ø 120 cm / 47.30"</p> <p>H 270 cm / 106.30"</p> <p>W 60 kg / 132.27 lb</p>
<p>WW 10×E27×60 W max (not included)</p> <p>USA 10×E26×60 W max (not included)</p>	<p>WW 12×E27×60 W max (not included)</p> <p>USA 12×E26×60 W max (not included)</p>	<p>WW 15×E27×60 W max (not included)</p> <p>11×E14×40 W max (not included)</p> <p>USA 15×E26×60 W max (not included)</p> <p>11×E12×40 W max (not included)</p>



VE 770/S34 



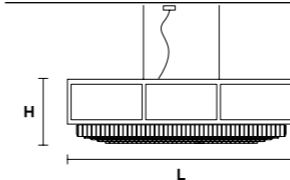
-
- L** 160 cm / 63.00"
- SP** 40 cm / 15.75"
- H** 40 cm / 15.75"
- W** 58 kg / 127.86 lb
-
- WW** 34×E14×40 W max (not included)
- USA** 34×E12×40 W max (not included)



VE 770/S34



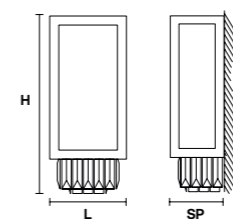
VE 770/S28



L 120 cm / 47.20"
SP 40 cm / 15.75"
H 40 cm / 15.75"
W 48 kg / 105.82 lb

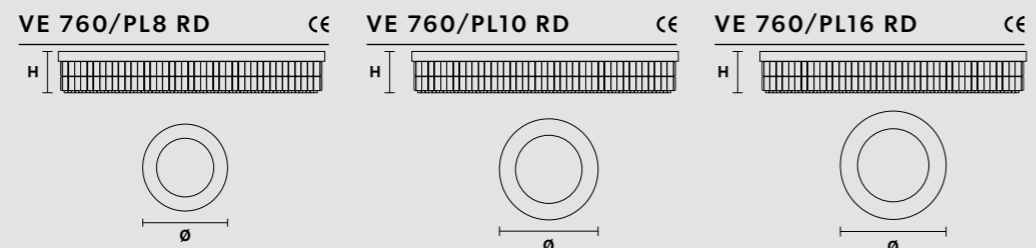
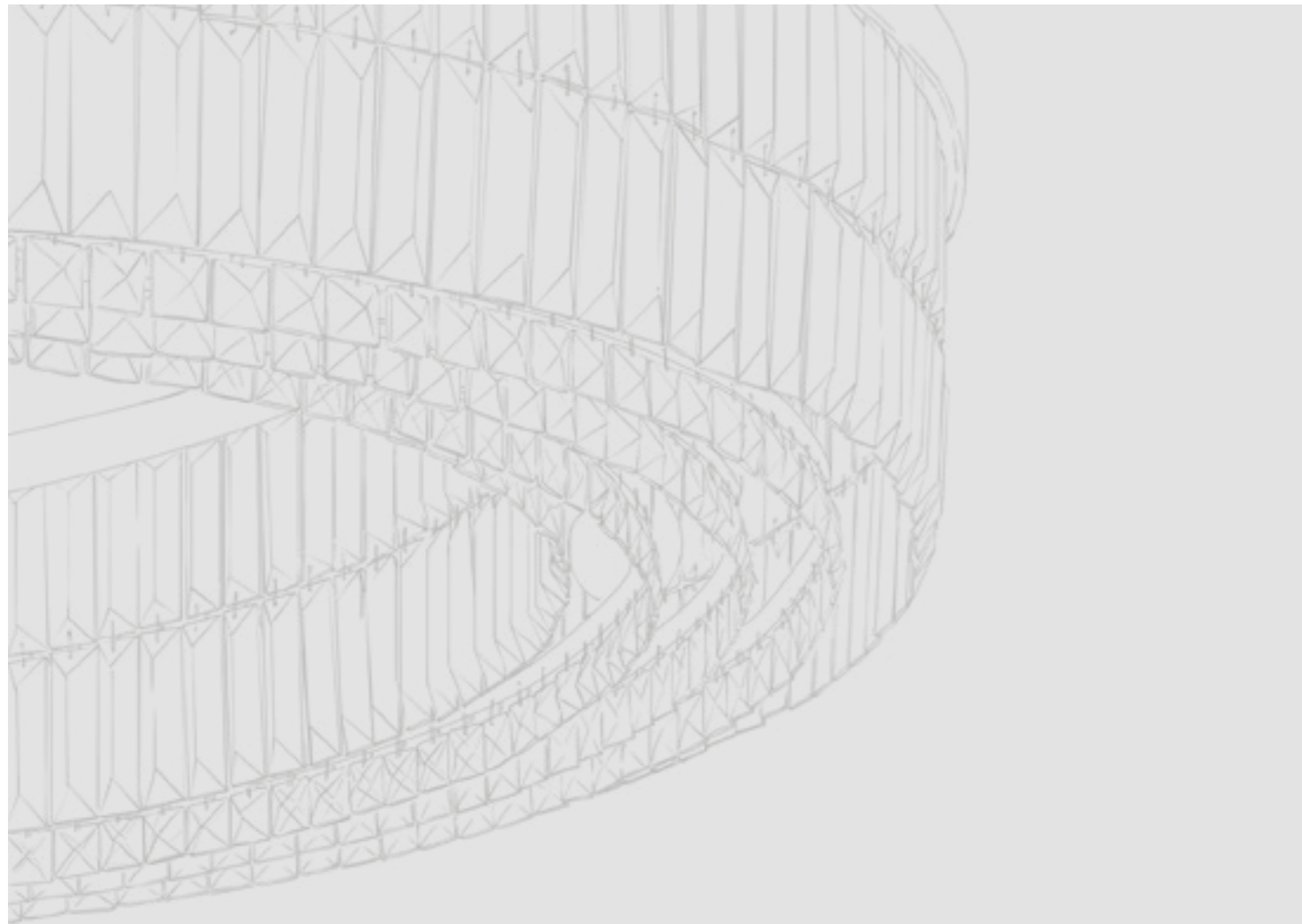
WW 28×E14×40 W max (not included)
USA 28×E12×40 W max (not included)

VE 770/ A2



L 17 cm / 6.65"
SP 12 cm / 4.70"
H 40 cm / 15.75"
W 4 kg / 8.81lb

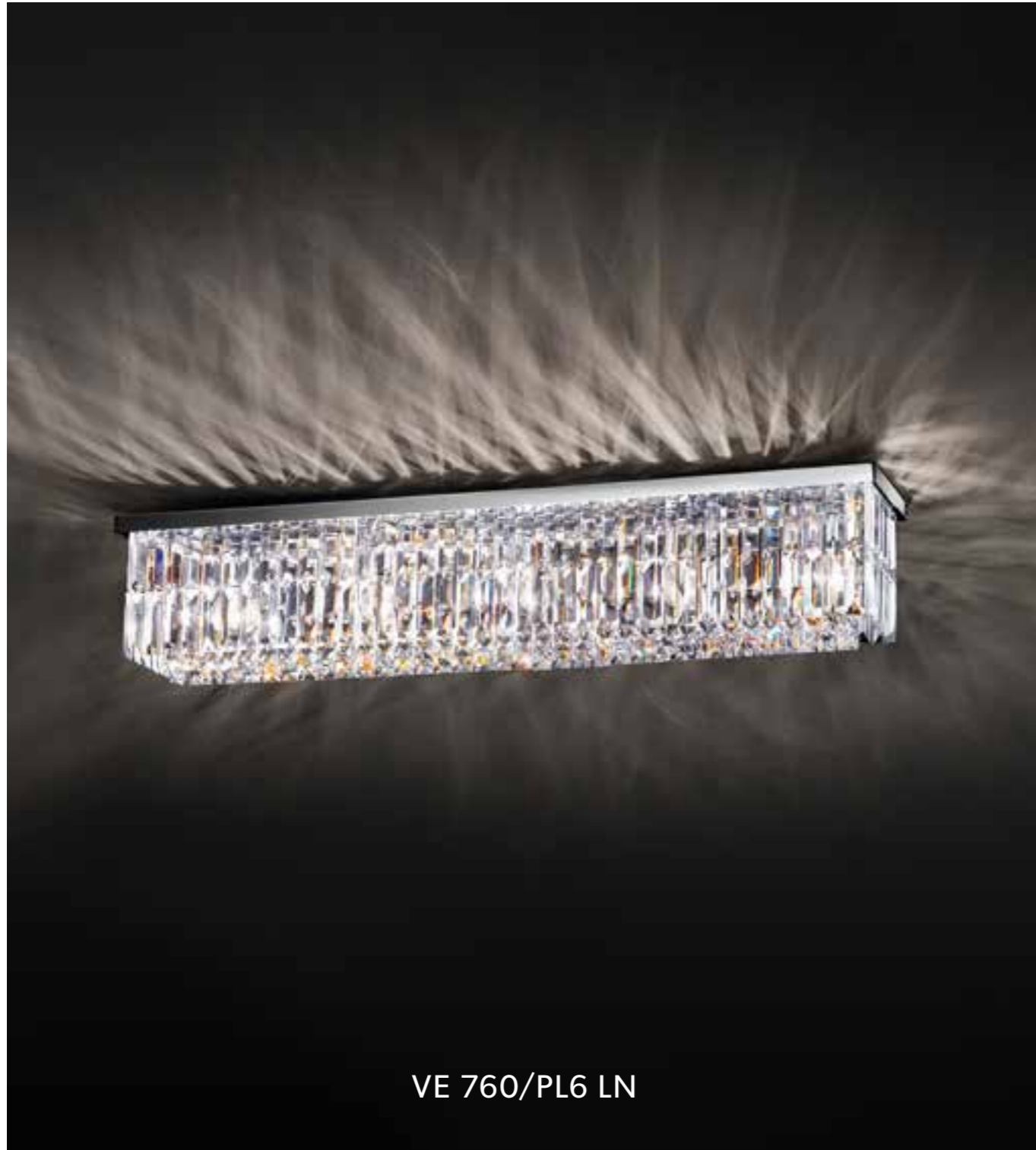
WW 2×E14×40 W max (not included)
USA 2×E12×40 W max (not included)



<p>Ø 60 cm / 23.62" H 18 cm / 7.08" W 21 kg / 46.29 lb</p> <p>WW 8×E27×60 W max (not included) USA 8×E26×60 W max (not included)</p>	<p>Ø 90 cm / 35.43" H 18 cm / 7.08" W 32 kg / 70.54 lb</p> <p>WW 10×E27×60 W max (not included) USA 10×E26×60 W max (not included)</p>	<p>Ø 120 cm / 47.24" H 18 cm / 7.08" W 40 kg / 88.18 lb</p> <p>WW 16×E27×60 W max (not included) USA 16×E26×60 W max (not included)</p>
--	--	---

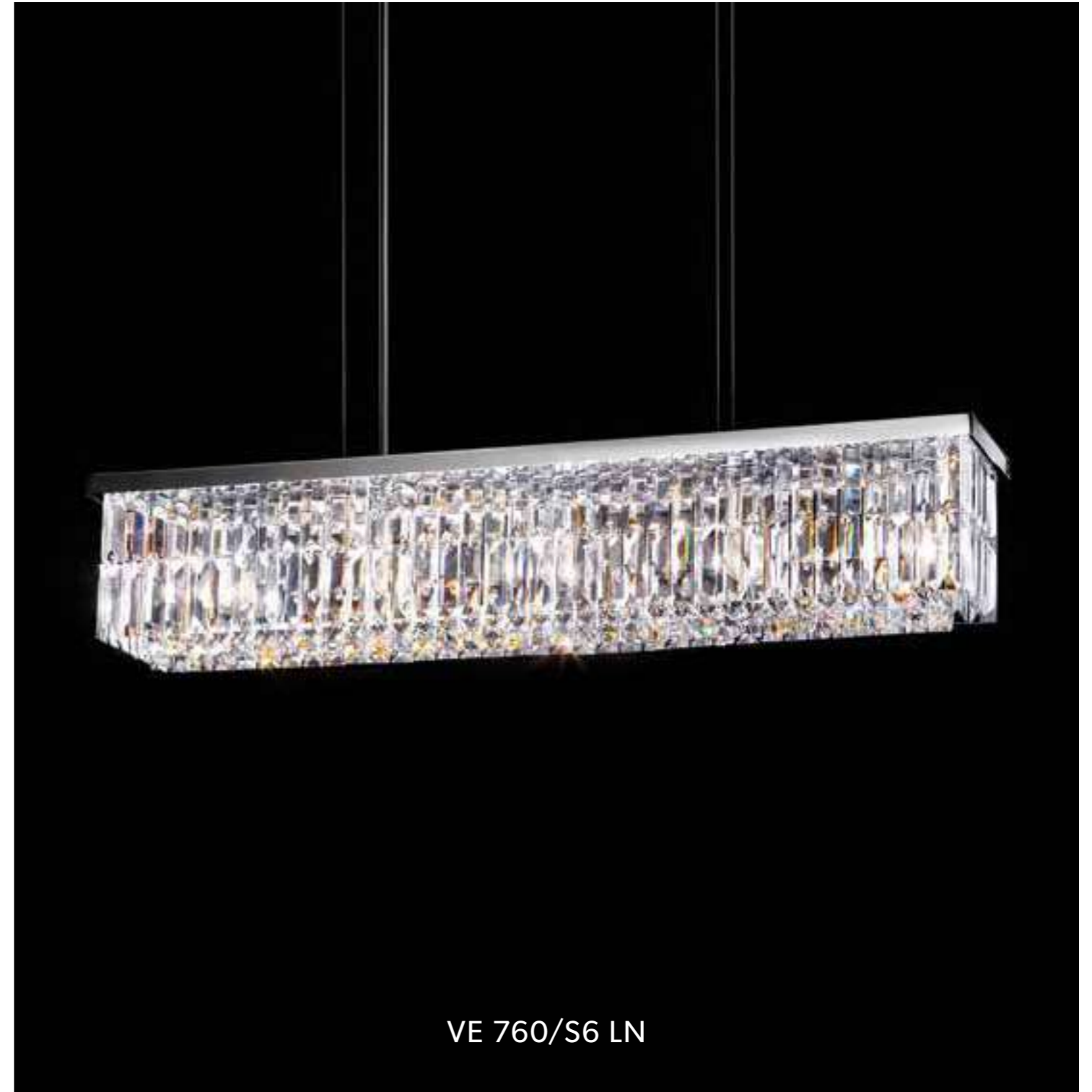


VE 760/PL16 RD



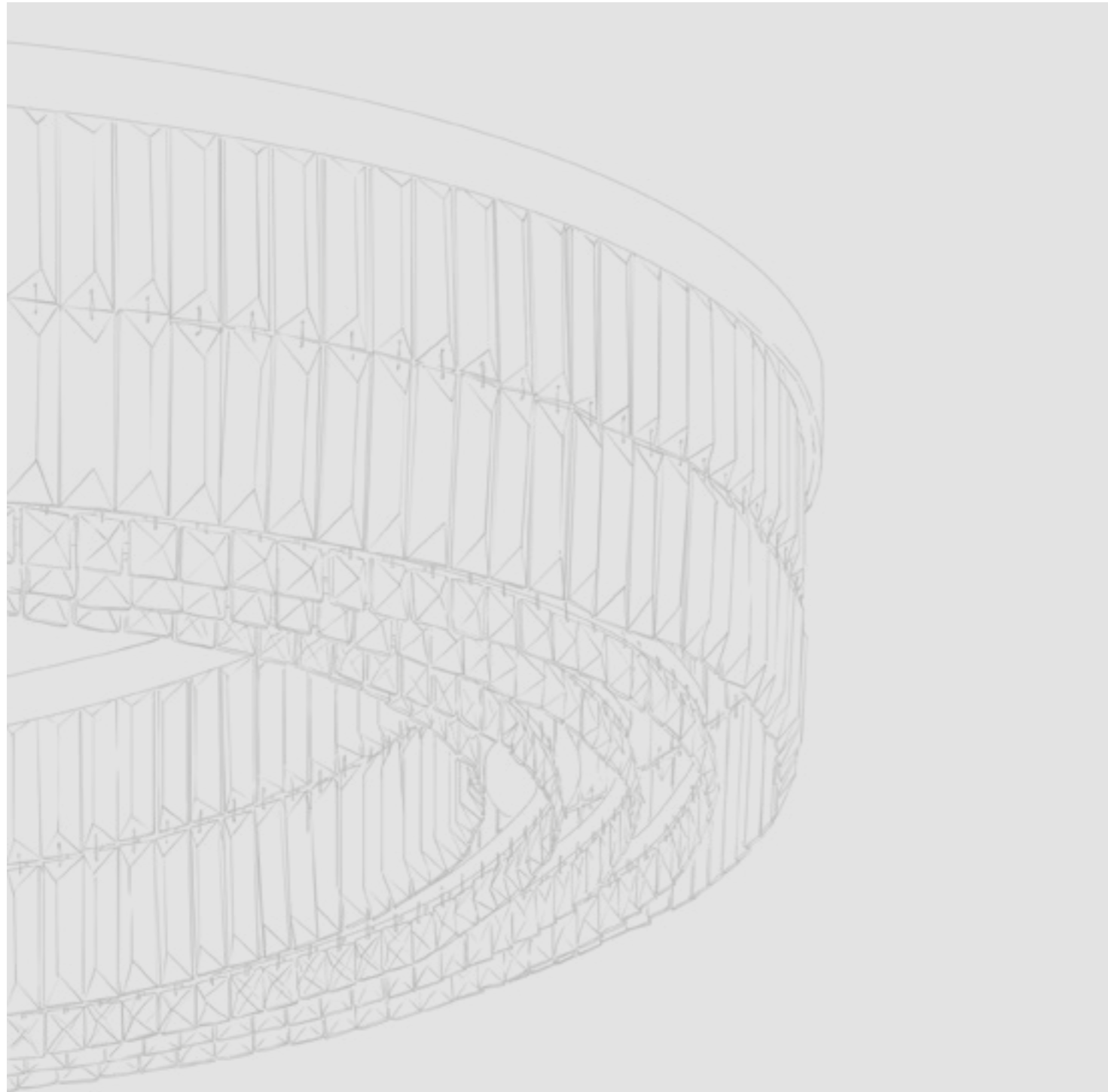
VE 760/PL6 LN

VE 760/PL5 LN	CE	VE 760/PL6 LN	CE	VE 760/PL7 LN	CE
L 80 cm / 31.49"		L 100 cm / 39.37"		L 120 cm / 47.24"	
SP 17 cm / 6.70"		SP 17 cm / 6.70"		SP 17 cm / 6.70"	
H 18 cm / 7.08"		H 18 cm / 7.08"		H 18 cm / 7.08"	
W 12 kg / 26.45 lb		W 15 kg / 33.06 lb		W 18 kg / 39.68 lb	
WW 5×E27×60 W max (not included)		WW 6×E27×60 W max (not included)		WW 7×E27×60 W max (not included)	
USA 5×E26×60 W max (not included)		USA 6×E26×60 W max (not included)		USA 7×E26×60 W max (not included)	

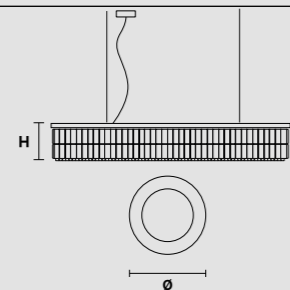


VE 760/S6 LN

VE 760/S5 LN	CE	VE 760/S6 LN	CE	VE 760/S7 LN	CE
L 80 cm / 31.49"		L 100 cm / 39.37"		L 120 cm / 47.24"	
SP 17 cm / 6.70"		SP 17 cm / 6.70"		SP 17 cm / 6.70"	
H 18 cm / 7.08"		H 18 cm / 7.08"		H 18 cm / 7.08"	
W 12 kg / 26.45 lb		W 15 kg / 33.06 lb		W 18 kg / 39.68 lb	
WW 5×E27×60 W max (not included)		WW 6×E27×60 W max (not included)		WW 7×E27×60 W max (not included)	
USA 5×E26×60 W max (not included)		USA 6×E26×60 W max (not included)		USA 7×E26×60 W max (not included)	



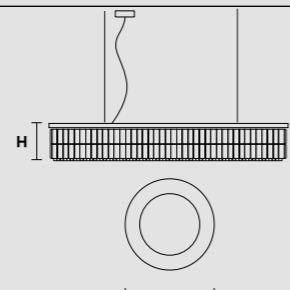
VE 760/S8 RD 



Ø 60 cm / 23.62"
H 18 cm / 7.08"
W 21 kg / 46.29 lb


WW 8×E27×60 W max (not included)
USA 8×E26×60 W max (not included)

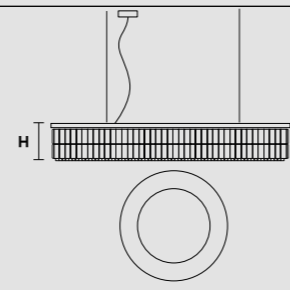
VE 760/S10 RD 



Ø 90 cm / 35.43"
H 18 cm / 7.08"
W 32 kg / 70.54 lb

WW 10×E27×60 W max (not included)
USA 10×E26×60 W max (not included)

VE 760/S16 RD 



Ø 120 cm / 47.24"
H 18 cm / 7.08"
W 40 kg / 88.18 lb

WW 16×E27×60 W max (not included)
USA 16×E26×60 W max (not included)



VE 760/S16 RD



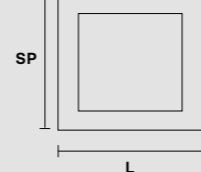
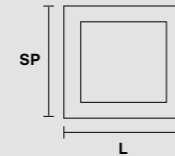
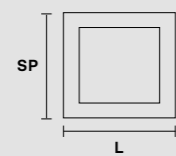
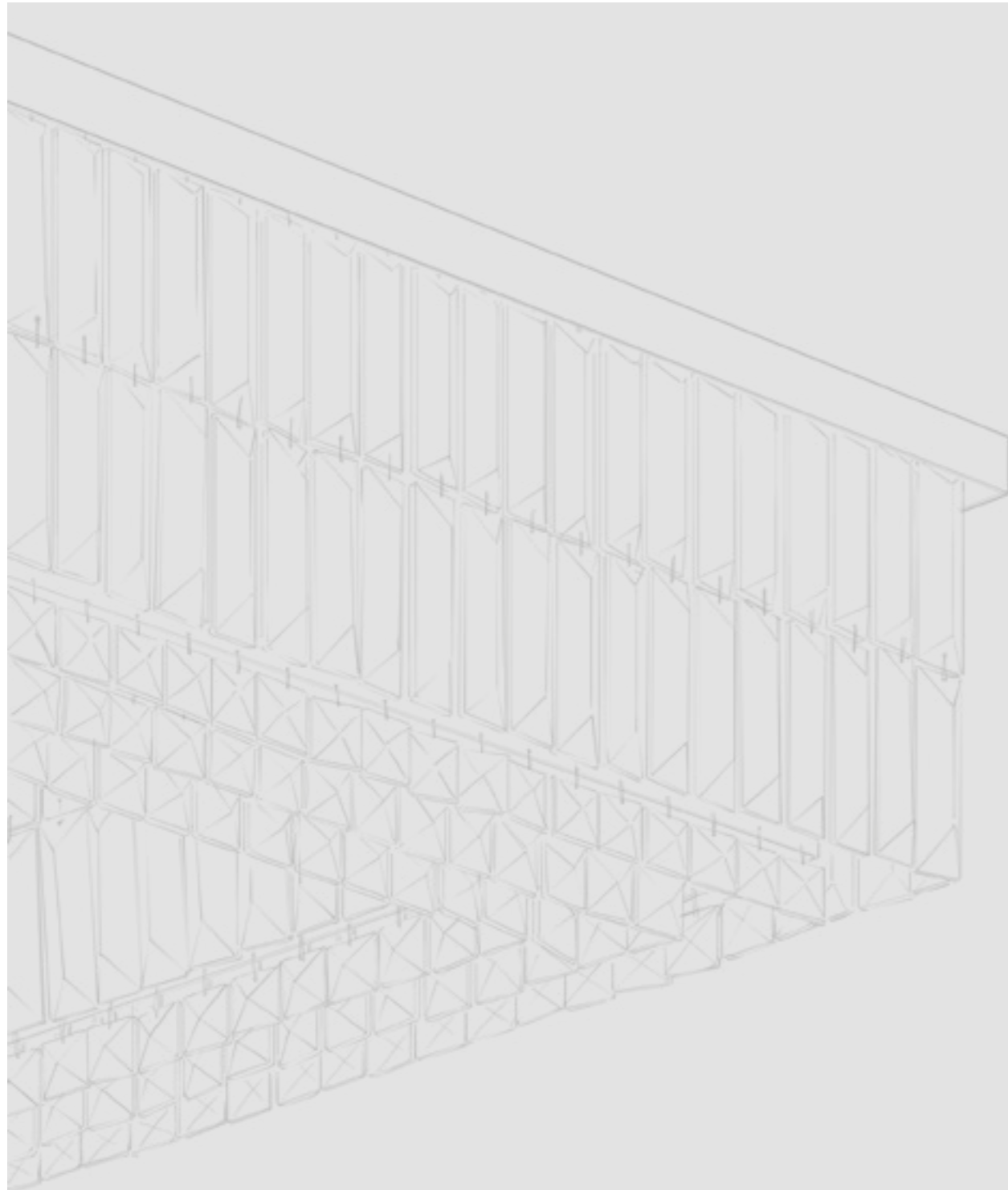
VE 760/PL26 RC

VE 760/PL16 RC	VE 760/PL20 RC	VE 760/PL26 RC
L 100 cm / 39.37" SP 60 cm / 23.62" H 18 cm / 7.08" W 27 kg / 59.52lb	L 150 cm / 59.05" SP 60 cm / 23.62" H 18 cm / 7.08" W 35 kg / 77.16lb	L 200 cm / 78.74" SP 80 cm / 31.49" H 18 cm / 7.08" W 52 kg / 114.64 lb
WW 16×E27×60 W max (not included) USA 16×E26×60 W max (not included)	WW 20×E27×60 W max (not included) USA 20×E26×60 W max (not included)	WW 26×E27×60 W max (not included) USA 26×E26×60 W max (not included)



VE 760/S26 RC

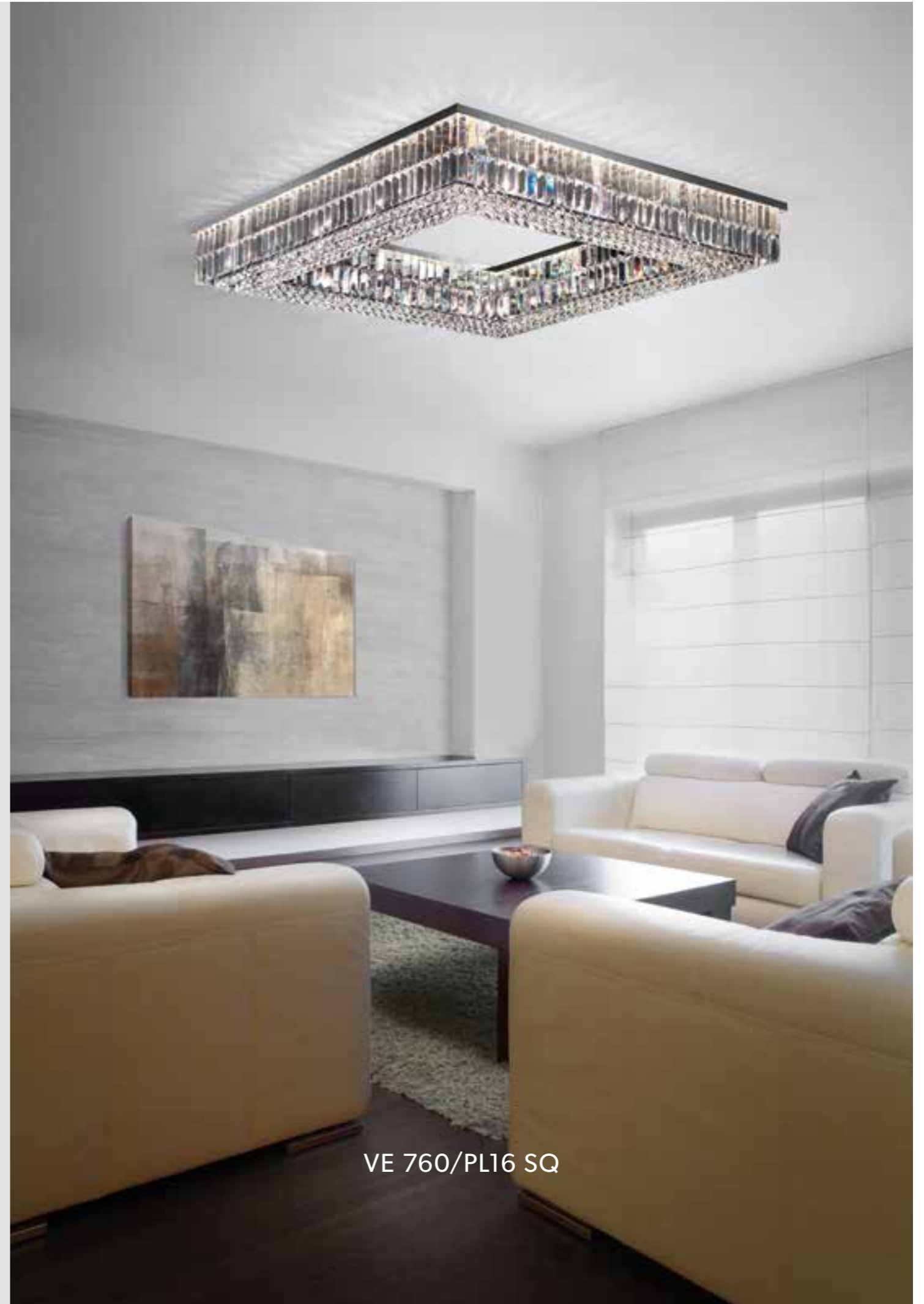
VE 760/S16 RC	VE 760/S20 RC	VE 760/S26 RC
L 100 cm / 39.37" SP 60 cm / 23.62" H 18 cm / 7.08" W 27 kg / 59.52lb	L 150 cm / 59.05" SP 60 cm / 23.62" H 18 cm / 7.08" W 35 kg / 77.16lb	L 200 cm / 78.74" SP 80 cm / 31.49" H 18 cm / 7.08" W 52 kg / 114.64 lb
WW 16×E27×60 W max (not included) USA 16×E26×60 W max (not included)	WW 20×E27×60 W max (not included) USA 20×E26×60 W max (not included)	WW 26×E27×60 W max (not included) USA 26×E26×60 W max (not included)



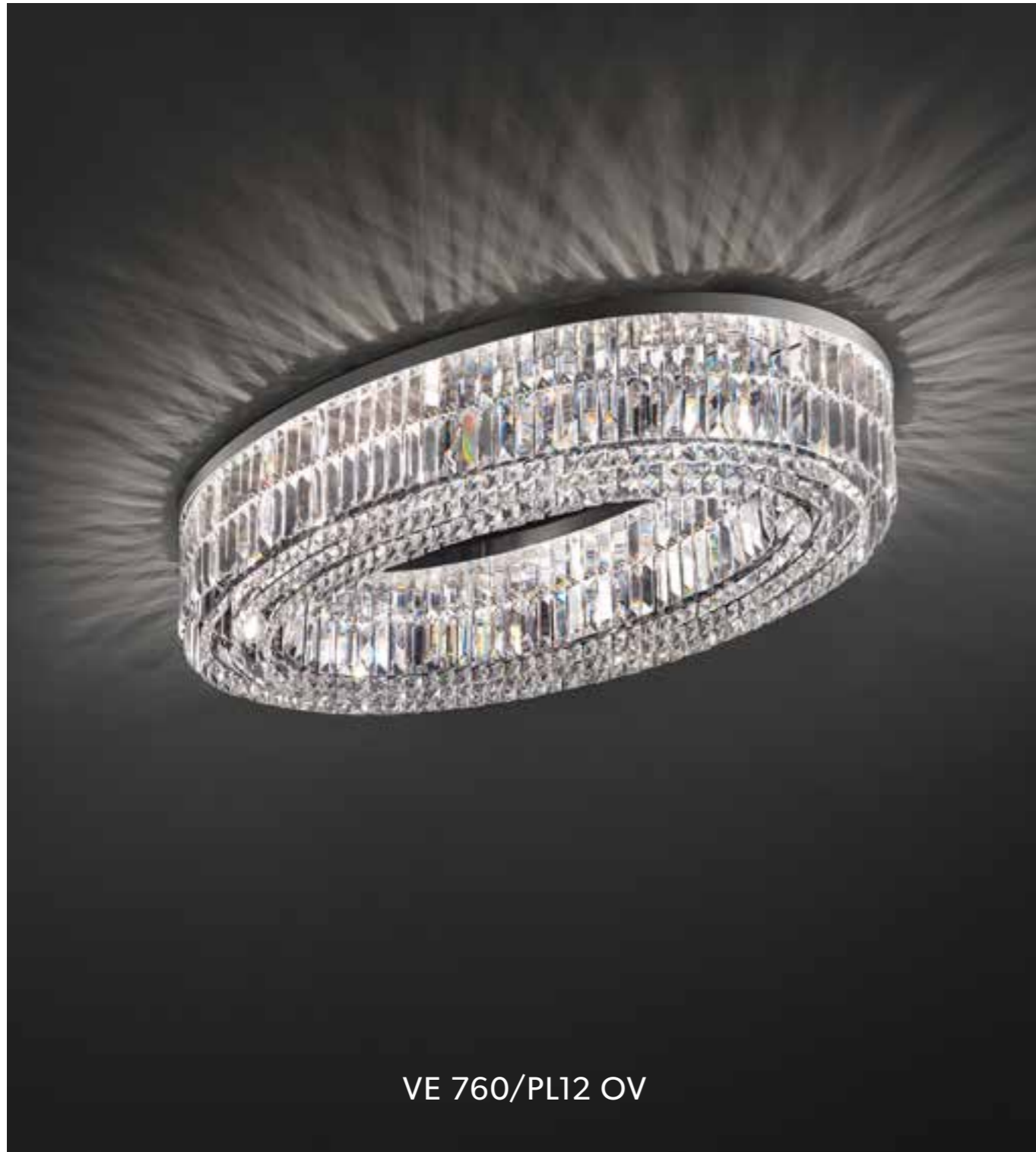
L 60 cm / 23.62"
SP 60 cm / 23.62"
H 18 cm / 7.08"
W 20 kg / 44.09 lb
WW 12×E27×60 W max (not included)
USA 12×E26×60 W max (not included)

L 90 cm / 35.40"
SP 90 cm / 35.40"
H 18 cm / 7.08"
W 30 kg / 66.13 lb
WW 16×E27×60 W max (not included)
USA 16×E26×60 W max (not included)

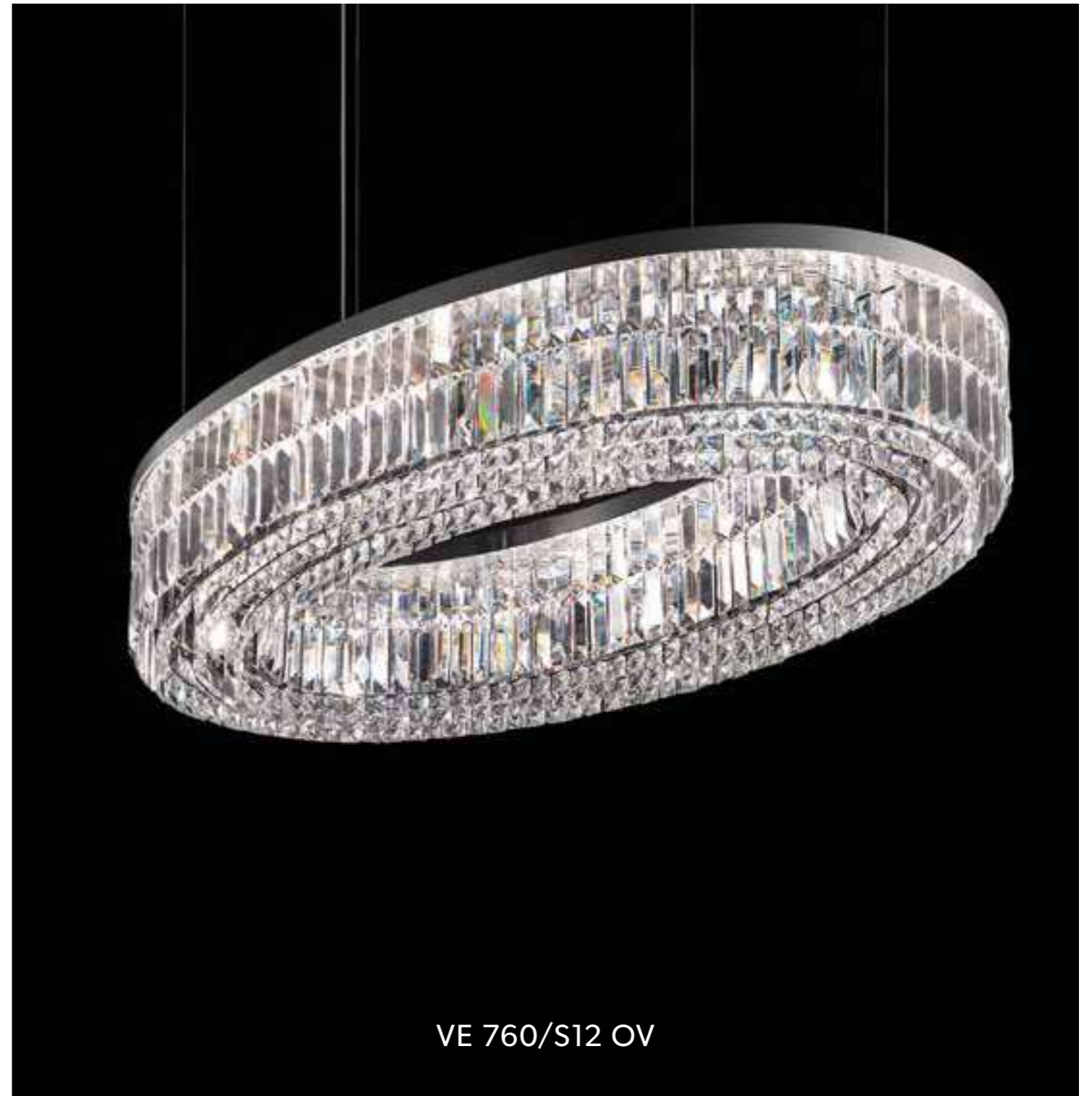
L 120 cm / 47.24"
SP 120 cm / 47.24"
H 18 cm / 7.08"
W 40 kg / 88.18 lb
WW 24×E27×60 W max (not included)
USA 24×E26×60 W max (not included)



VE 760/PL16 SQ



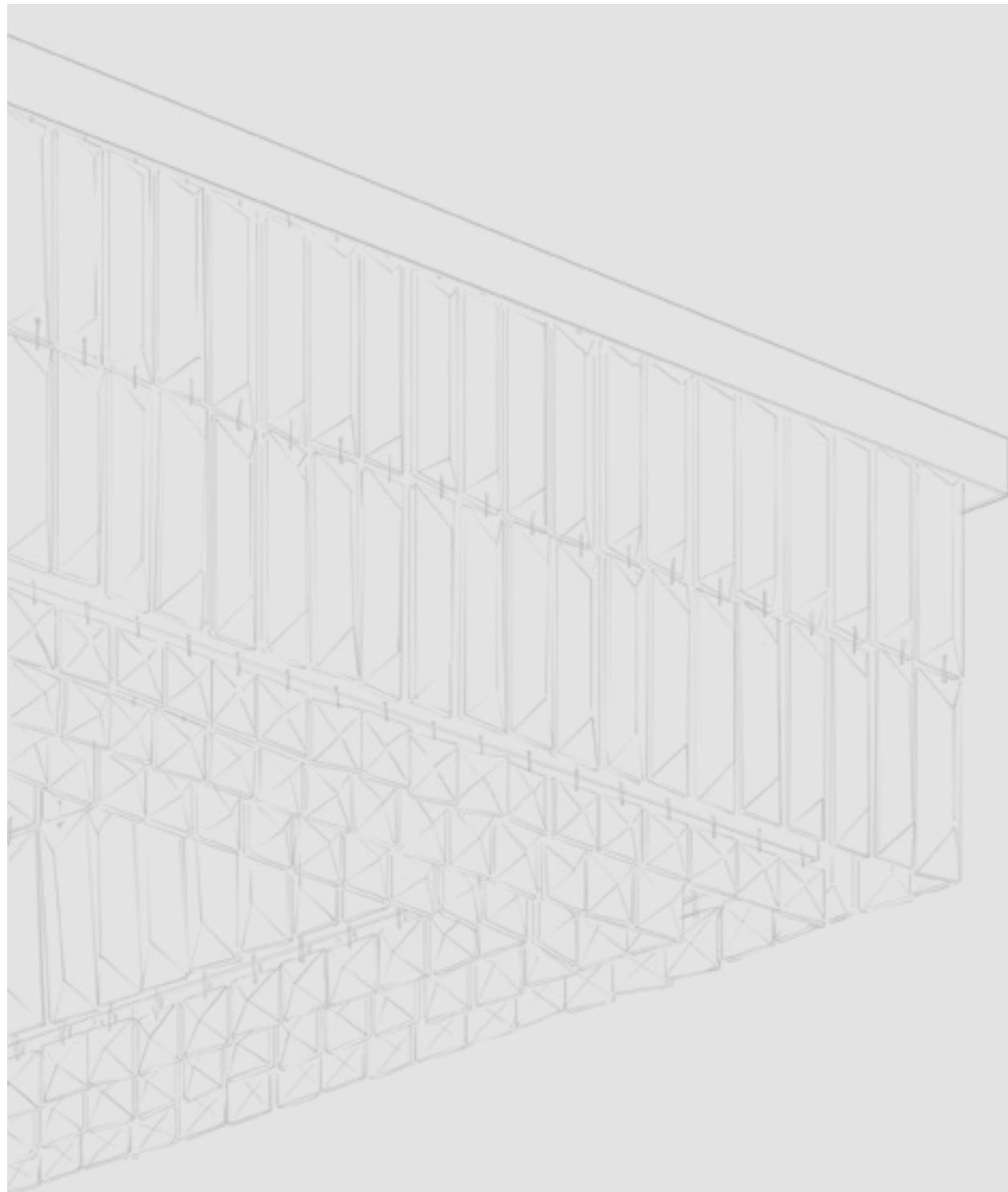
VE 760/PL12 OV




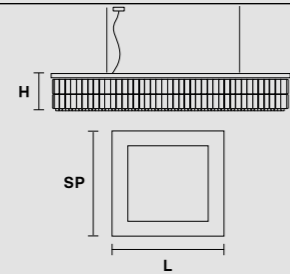
VE 760/S12 OV

VE 760/PL12 OV	VE 760/PL16 OV	VE 760/PL22 OV
L 103 cm / 40.55" SP 63 cm / 24.80" H 18 cm / 7.08" W 21 kg / 46.29 lb	L 150 cm / 59.10" SP 75 cm / 29.50" H 18 cm / 7.08" W 40 kg / 88.18 lb	L 200 cm / 78.74" SP 85 cm / 33.50" H 18 cm / 7.08" W 59 kg / 130.07 lb
WW 12xE27x60 W max (not included) USA 12xE26x60 W max (not included)	WW 16xE27x60 W max (not included) USA 16xE26x60 W max (not included)	WW 22xE27x60 W max (not included) USA 22xE26x60 W max (not included)


VE 760/S12 OV	VE 760/S16 OV	VE 760/S22 OV
L 103 cm / 40.55" SP 63 cm / 24.80" H 18 cm / 7.08" W 21 kg / 46.29 lb	L 150 cm / 59.06" SP 75 cm / 29.50" H 18 cm / 7.08" W 40 kg / 88.18 lb	L 200 cm / 78.74" SP 85 cm / 33.50" H 18 cm / 7.08" W 59 kg / 130.07 lb
WW 12xE27x60 W max (not included) USA 12xE26x60 W max (not included)	WW 16xE27x60 W max (not included) USA 16xE26x60 W max (not included)	WW 22xE27x60 W max (not included) USA 22xE26x60 W max (not included)

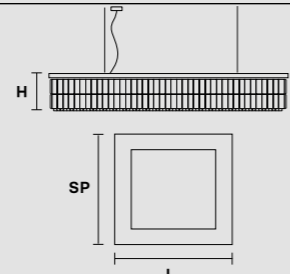


VE 760/S12 SQ 




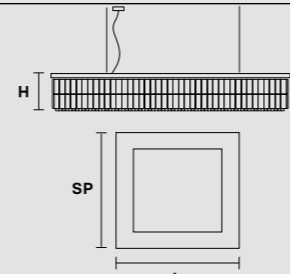
L 60 cm / 23.62"
SP 60 cm / 23.62"
H 18 cm / 7.08"
W 20 kg / 44.09 lb
WW 12×E27×60 W max (not included)
USA 12×E26×60 W max (not included)

VE 760/S16 SQ 



L 90 cm / 35.40"
SP 90 cm / 35.40"
H 18 cm / 7.08"
W 30 kg / 66.13 lb
WW 16×E27×60 W max (not included)
USA 16×E26×60 W max (not included)

VE 760/S24SQ 



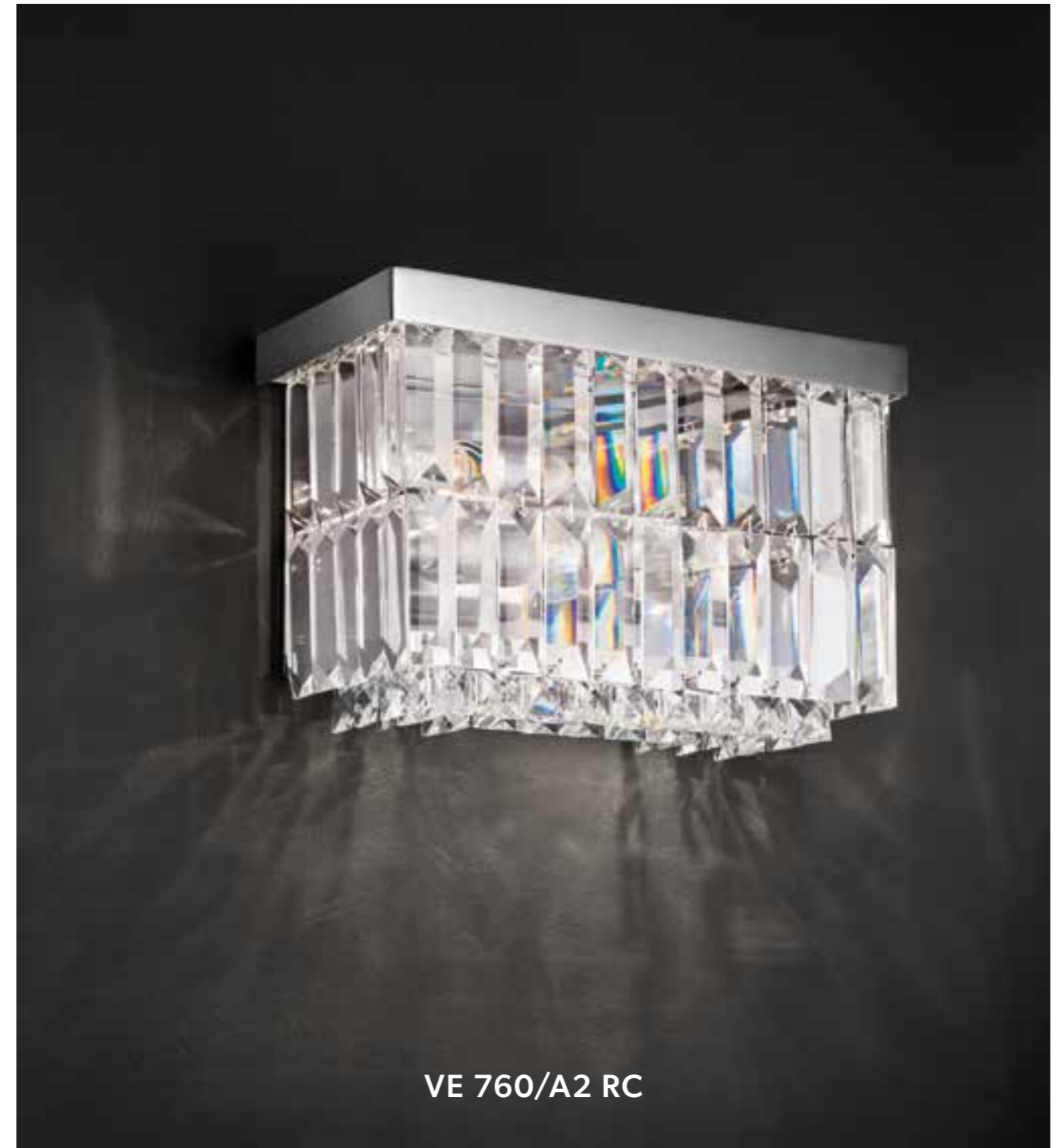
L 120 cm / 47.24"
SP 120 cm / 47.24"
H 18 cm / 7.08"
W 40 kg / 88.18 lb
WW 24×E27×60 W max (not included)
USA 24×E26×60 W max (not included)



VE 760/S16 SQ



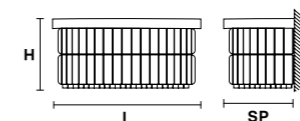
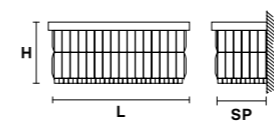
VE 760/A2 RD



VE 760/A2 RC

VE 760/A2 RD 

VE 760/A2 RC 

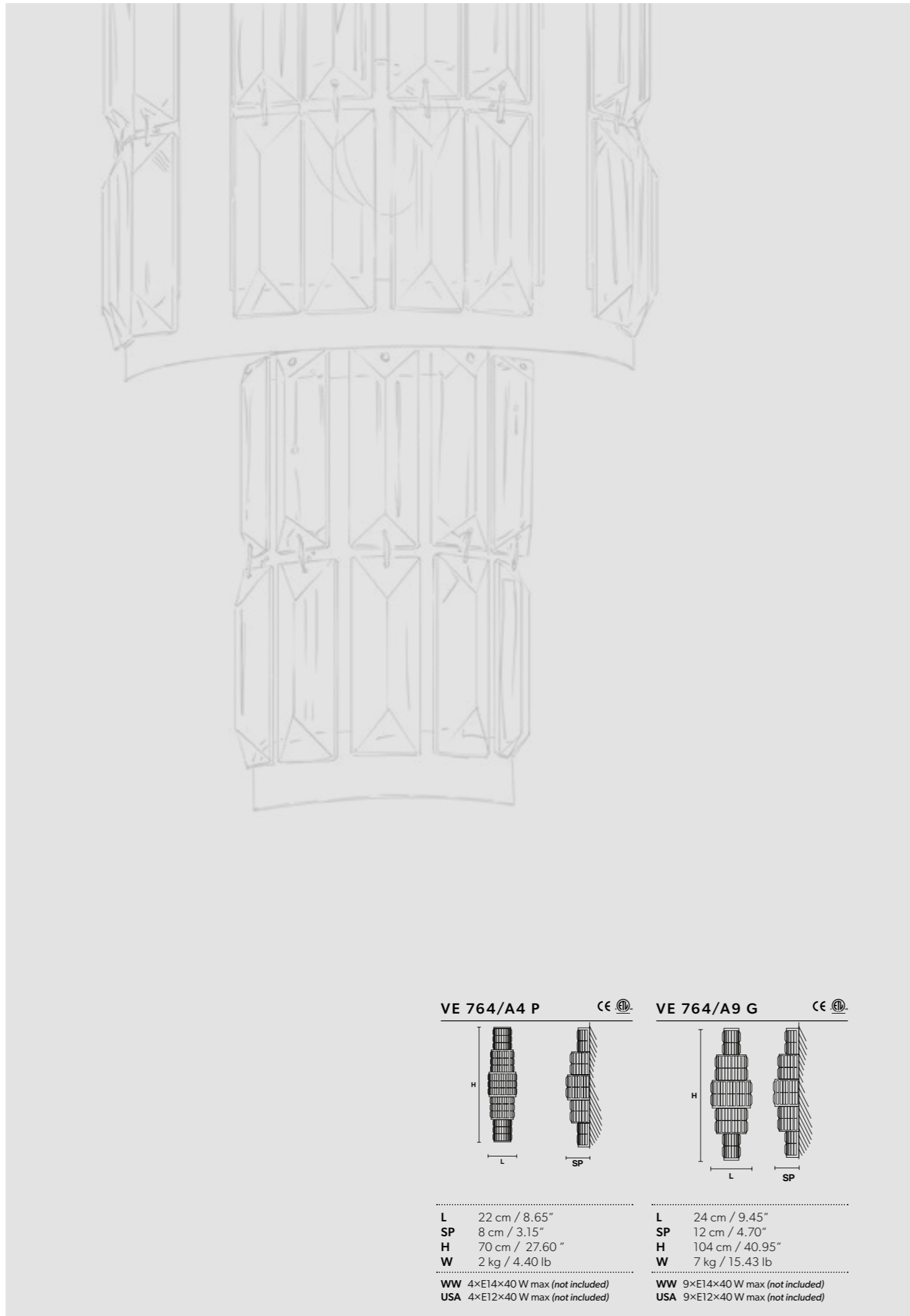


L 32 cm / 12.59"
SP 17 cm / 6.69"
H 18 cm / 7.10"
W 2 kg / 4.40 lb

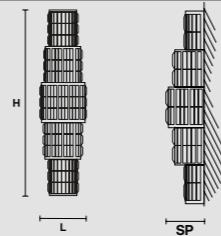
WW 2×E14×40 W max (not included)
USA 2×E12×40 W max (not included)

L 30 cm / 11.81"
SP 14 cm / 5.51 "
H 18 cm / 7.10"
W 2 kg / 4.40 lb

WW 2×E14×40 W max (not included)
USA 2×E12×40 W max (not included)



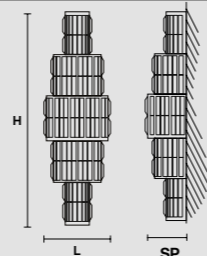
VE 764/A4 P 



L 22 cm / 8.65"
SP 8 cm / 3.15"
H 70 cm / 27.60"
W 2 kg / 4.40 lb

WW 4×E14×40 W max (not included)
USA 4×E12×40 W max (not included)

VE 764/A9 G 



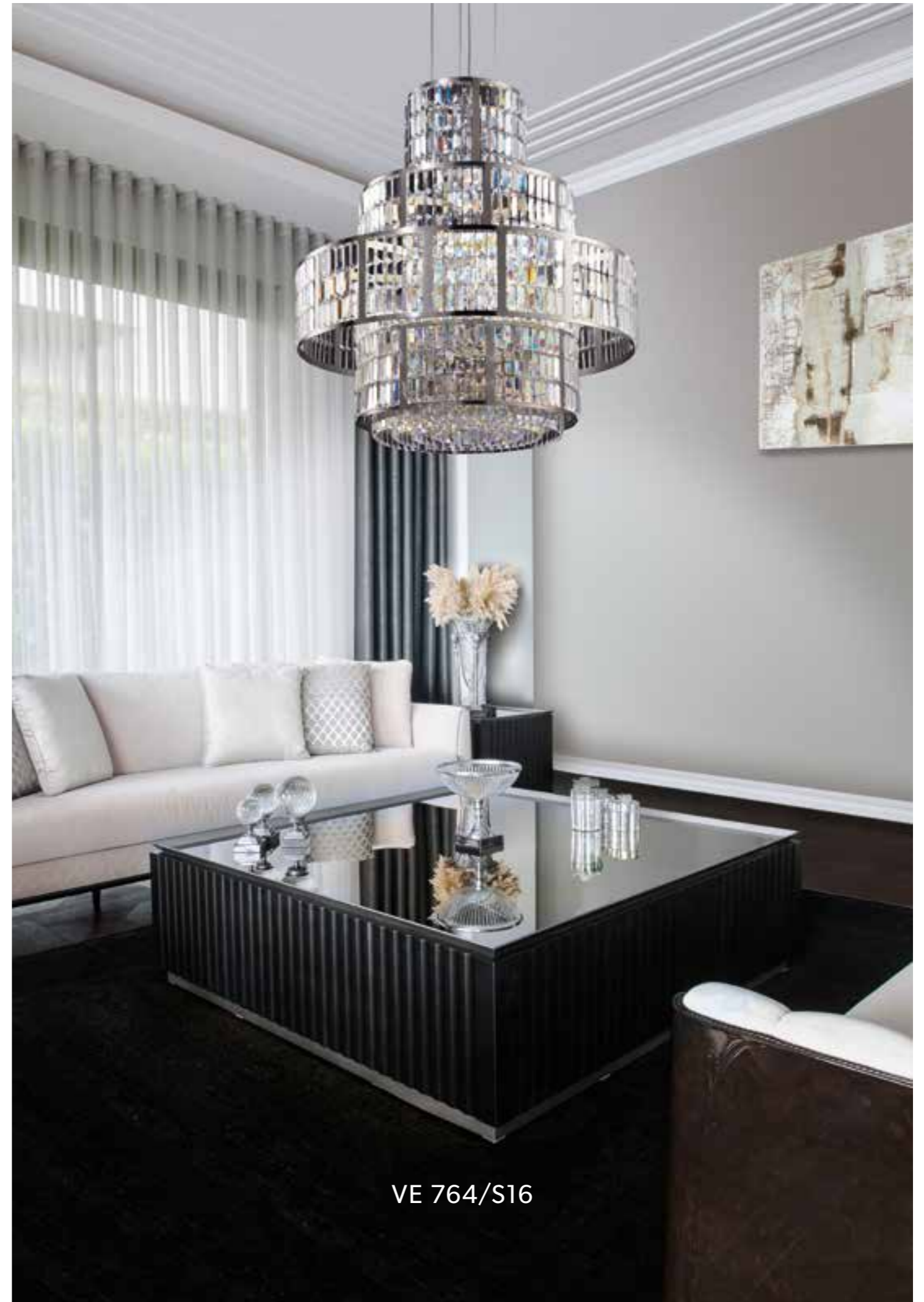
L 24 cm / 9.45"
SP 12 cm / 4.70"
H 104 cm / 40.95"
W 7 kg / 15.43 lb


WW 9×E14×40 W max (not included)
USA 9×E12×40 W max (not included)

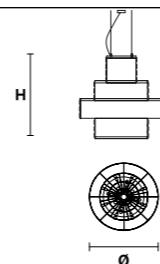


VE 764 A4 P

VE 764 A9 G



VE 764/S16 

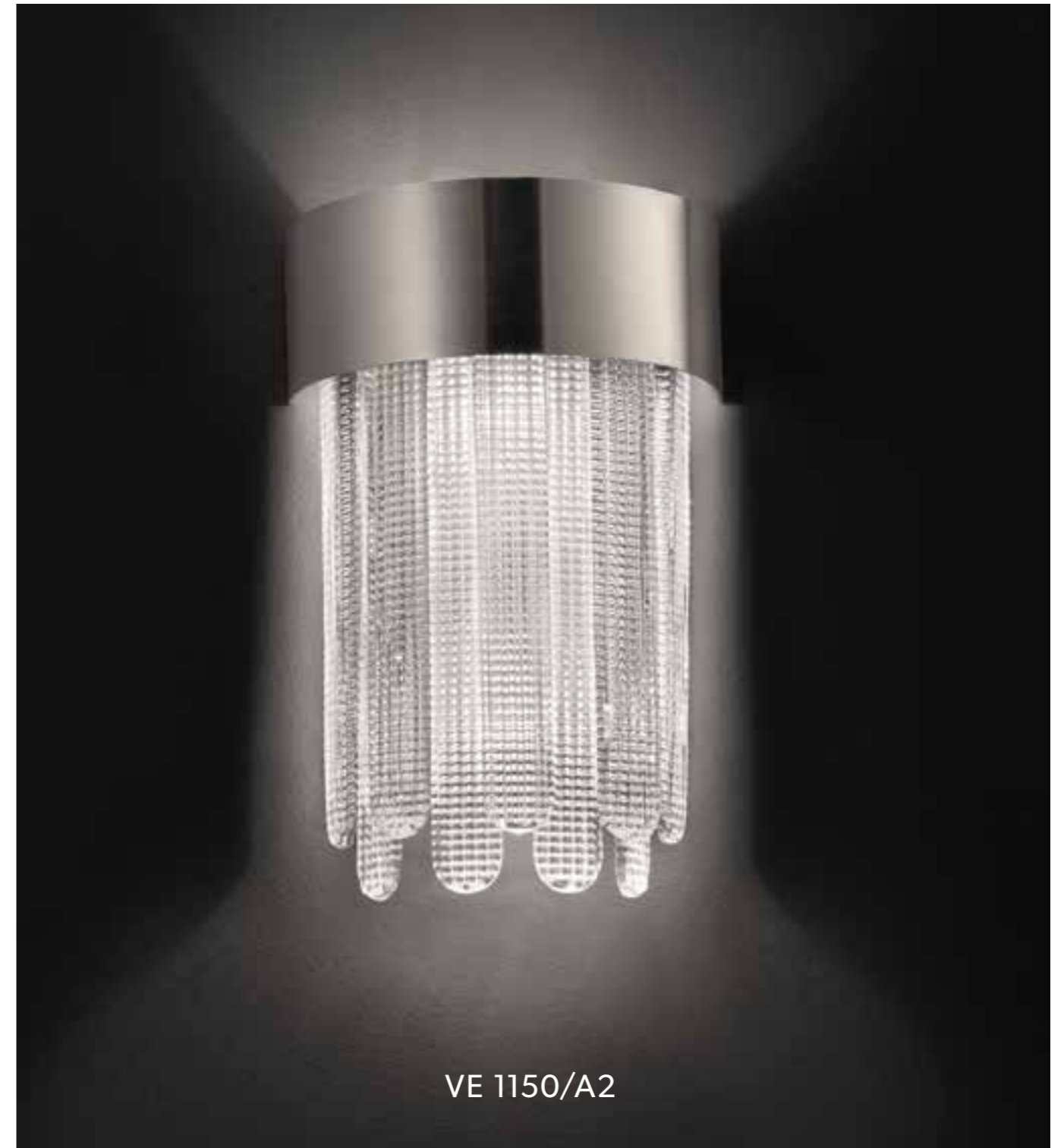


Ø 86 cm / 33.85"
H 88 cm / 34.65"
W 45 kg / 99.20 lb
WW 16×E27×60 W max (not included)
USA 16×E26×60 W max (not included)

VE 764/S16

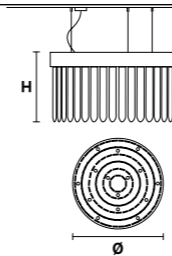


VE 1150/S12



VE 1150/A2

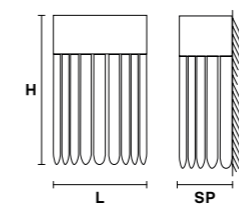
VE 1150/S12



Ø 90 cm / 35.40"
H 40 cm / 15.75"
W 50 kg / 110.23lb

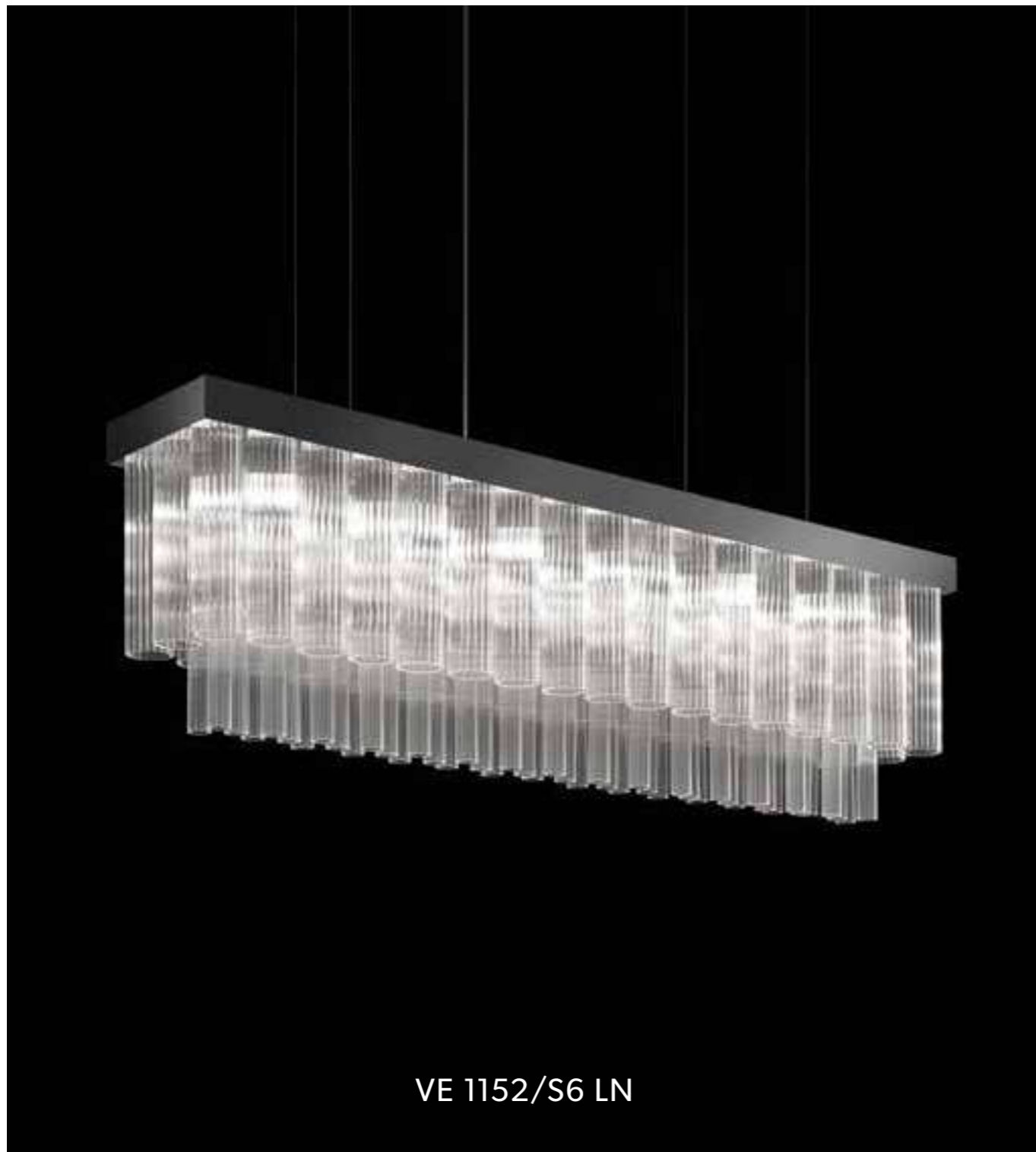
WW 12×E14×40 W max (not included)
USA 12×E12×40 W max (not included)

VE 1150/A2

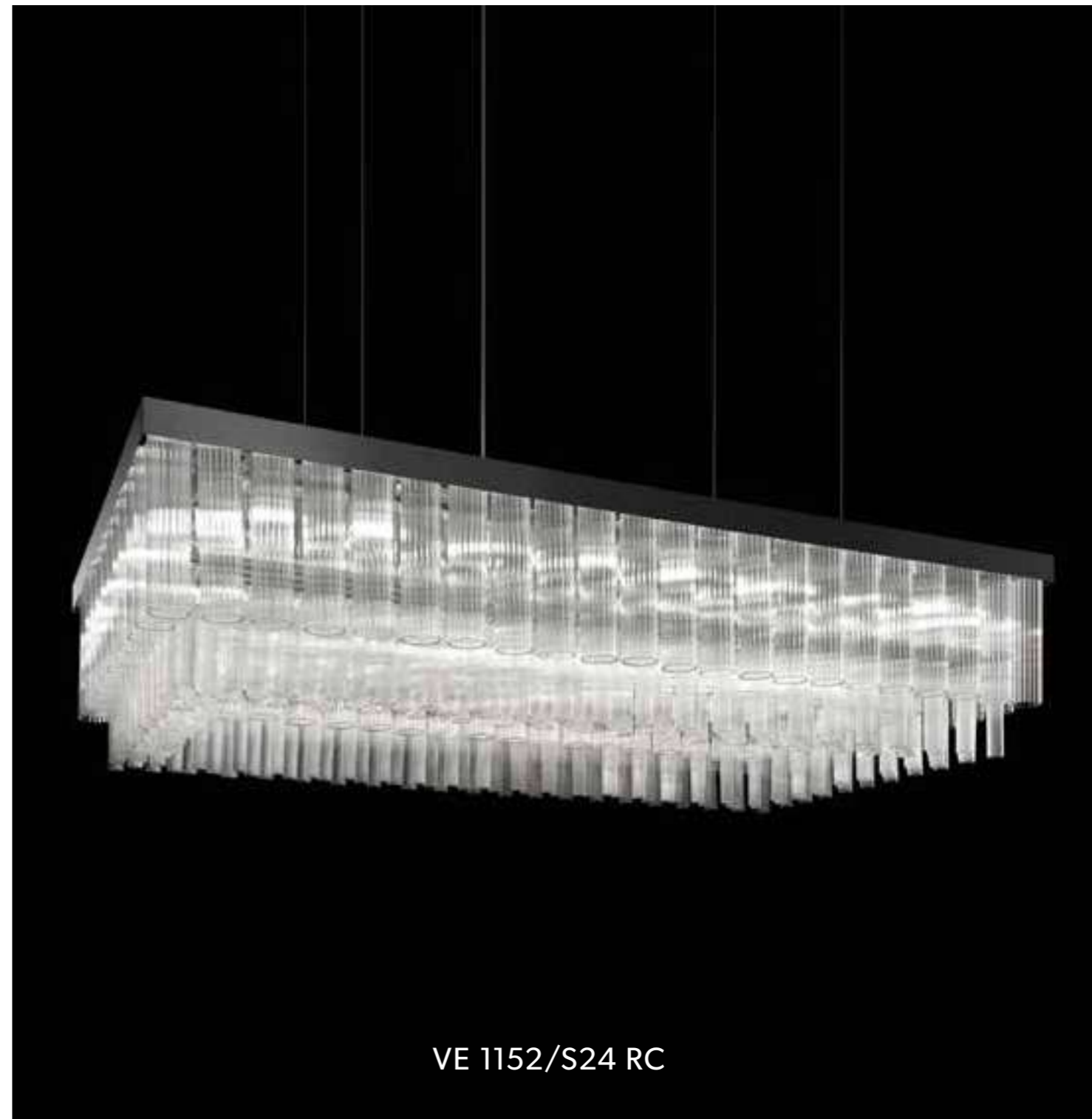


L 25 cm / 9.84"
SP 13 cm / 5.11"
H 40 cm / 15.74"
W 5 kg / 11.02 lb

WW 2×E14×40 W max (not included)
USA 2×E12×40 W max (not included)



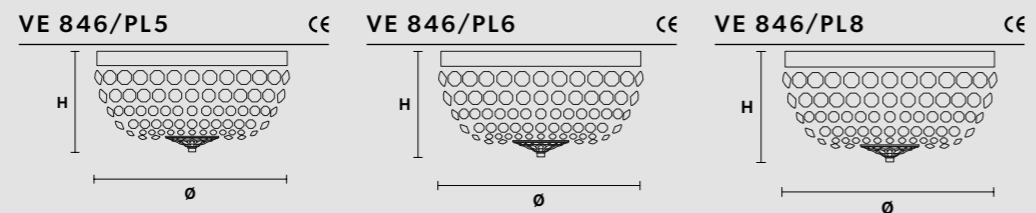
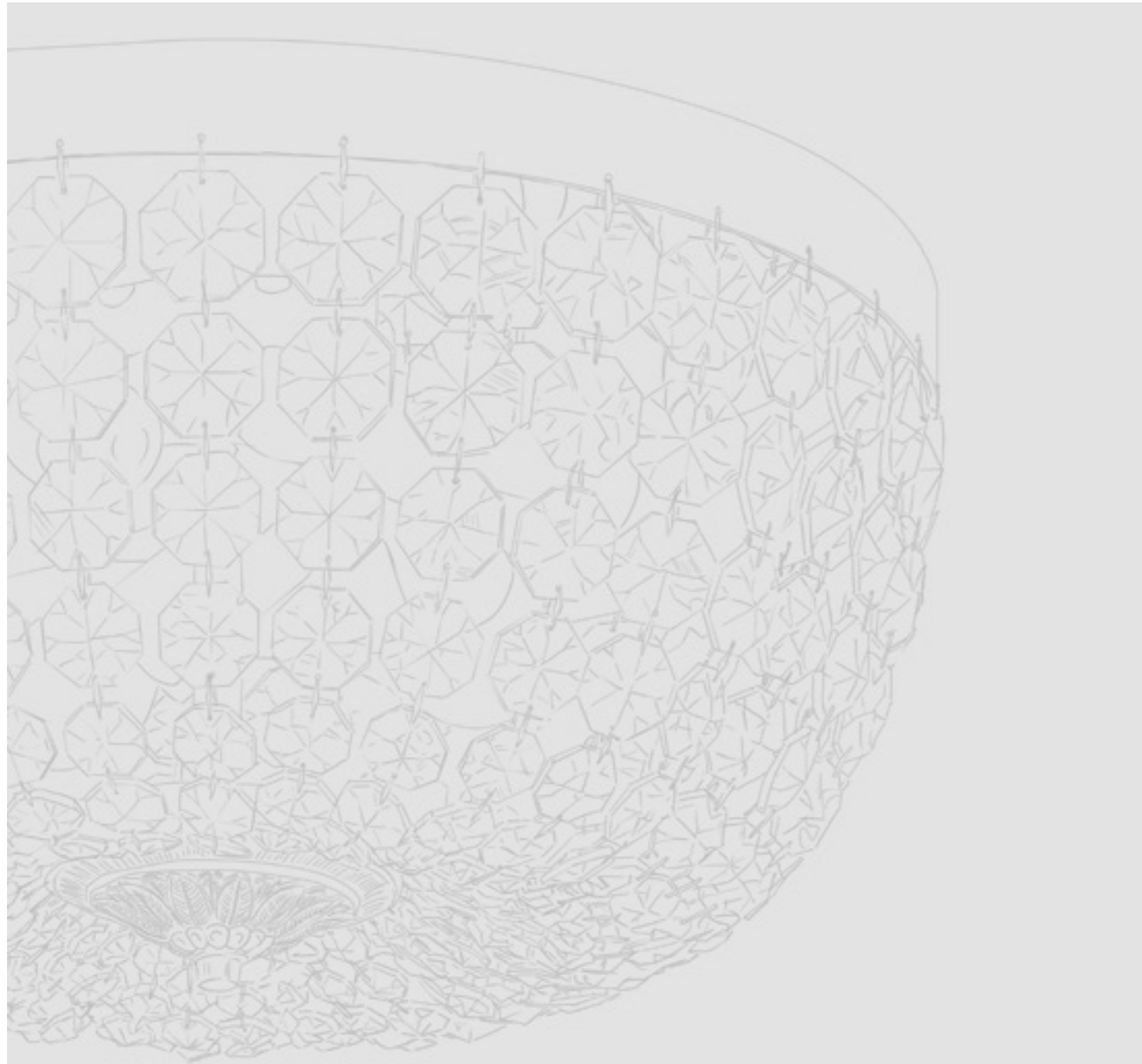
VE 1152/S6 LN



VE 1152/S24 RC

VE 1152/S4 LN	VE 1152/S5 LN	VE 1152/S6 LN
L 75 cm / 29.50" SP 22.5 cm / 8.85" H 38 cm / 14.95" W 15 kg / 33.00 lb	L 105 cm / 41.30" SP 22.5 cm / 8.85" H 38 cm / 14.95" W 20 kg / 44.00 lb	L 130 cm / 51.20" SP 22.5 cm / 8.85" H 38 cm / 14.95" W 24 kg / 52.80 lb
WW 4×E27×60 W max (not included) USA 4×E26×60 W max (not included)	WW 5×E27×60 W max (not included) USA 5×E26×60 W max (not included)	WW 6×E27×60 W max (not included) USA 6×E26×60 W max (not included)

VE 1152/S16 RC	VE 1152/S18 RC	VE 1152/S24 RC
L 105 cm / 41.30" SP 75 cm / 29.50" H 38 cm / 14.95" W 58 kg / 127.60 lb	L 130 cm / 51.20" SP 75 cm / 29.50" H 38 cm / 14.95" W 68 kg / 149.60 lb	L 165 cm / 64.95" SP 90 cm / 35.10" H 38 cm / 14.95" W 79 kg / 173.80 lb
WW 16×E27×60 W max (not included) USA 16×E26×60 W max (not included)	WW 18×E27×60 W max (not included) USA 18×E26×60 W max (not included)	WW 24×E27×60 W max (not included) USA 24×E26×60 W max (not included)

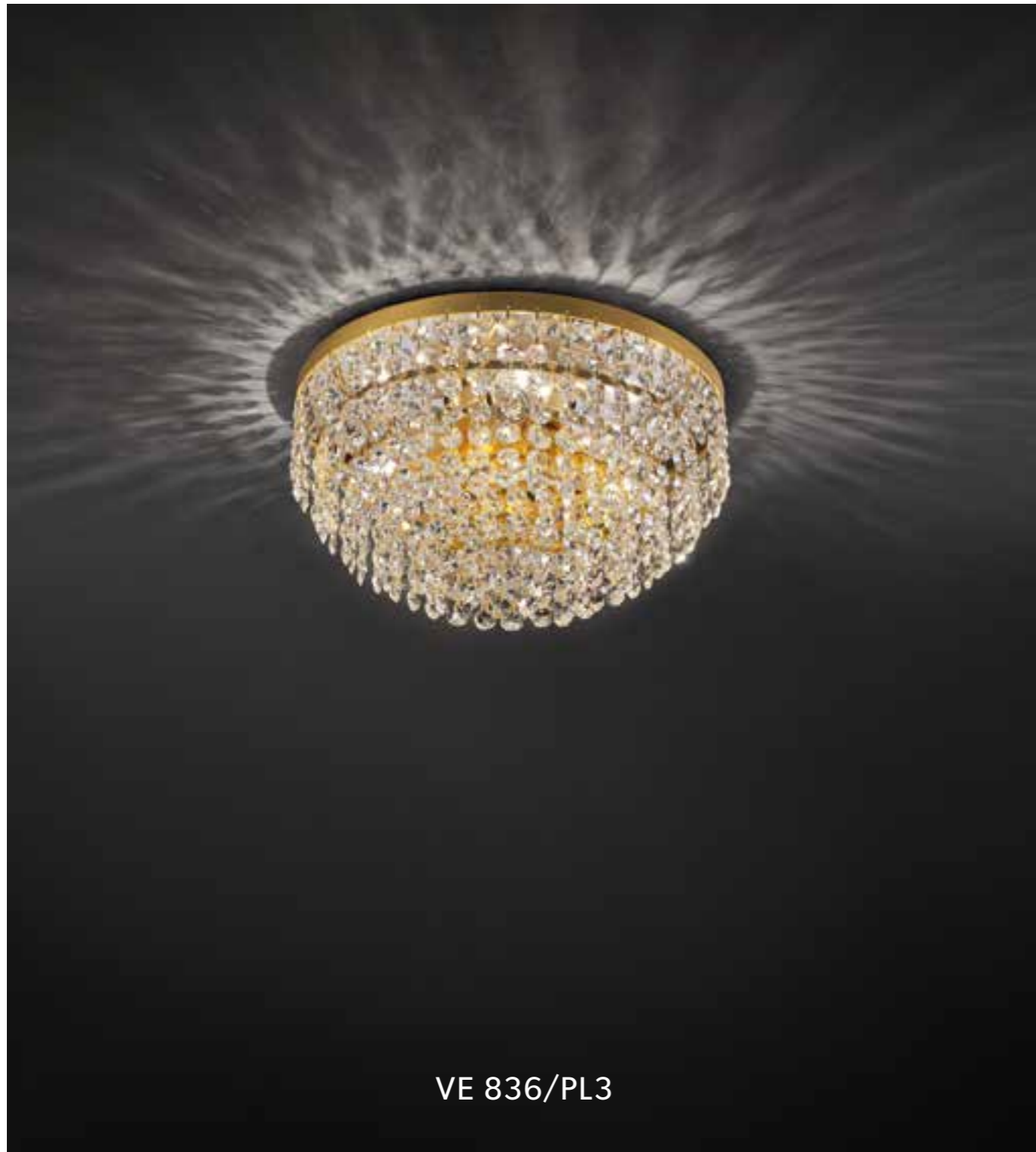


Ø 40 cm / 15.75"
H 20 cm / 7.87"
W 5 kg / 11.02 lb
WW 5×E14×40 W max (not included)
USA 5×E12×40 W max (not included)

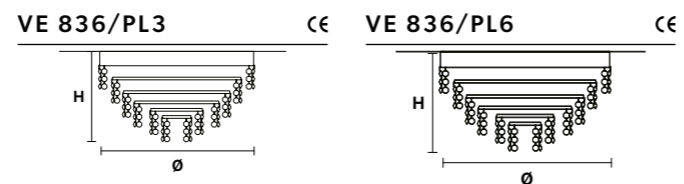
Ø 70 cm / 27.56"
H 35 cm / 13.78"
W 8 kg / 17.63 lb
WW 6×E14×40 W max (not included)
USA 6×E12×40 W max (not included)

Ø 80 cm / 31.50"
H 40 cm / 15.75"
W 10 kg / 22.04 lb
WW 8×E14×40 W max (not included)
USA 8×E12×40 W max (not included)

VE 846 PL5



VE 836/PL3

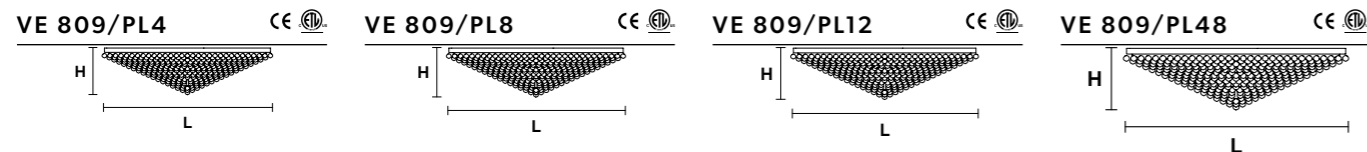
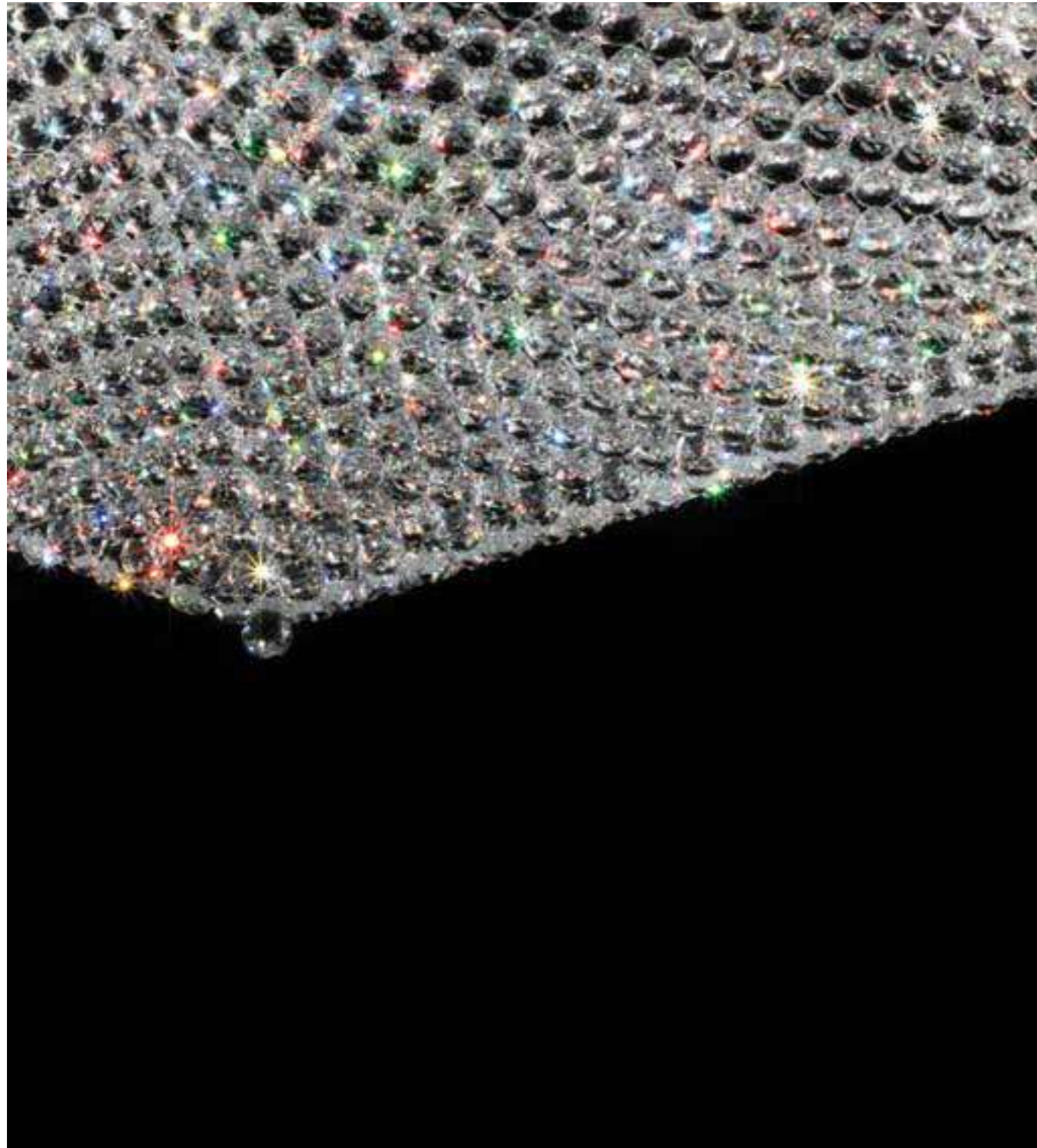


VE 836/PL3 **CE**
Ø 30 cm / 11.81"
H 25 cm / 9.84"
W 3.5 kg / 7.71 lb
WW 3×E14×40 W max (not included)
USA 3×E12×40 W max (not included)

VE 836/PL6 **CE**
Ø 40 cm / 15.75"
H 35 cm / 13.78"
W 4 kg / 8.81 lb
WW 6×E14×40 W max (not included)
USA 6×E12×40 W max (not included)



VE 836/PL6



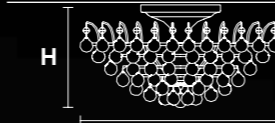
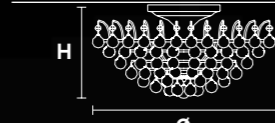
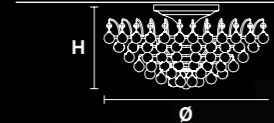
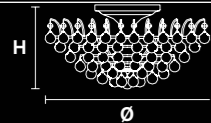
L 50 cm / 19.69"	L 70 cm / 27.56"	L 105 cm / 41.34"	L 160 cm / 62.99"
SP 50 cm / 19.69"	SP 70 cm / 27.56"	SP 105 cm / 41.34"	SP 160 cm / 62.99"
H 25 cm / 9.84"	H 30 cm / 11.81"	H 35 cm / 13.78"	H 40 cm / 15.75"
W 27 kg / 59.52 lb	W 30 kg / 66.13 lb	W 60 kg / 132.27 lb	W 120 kg / 264.5 lb
WW 4×E27×60 W max (not included)	WW 8×E27×60 W max (not included)	WW 12×E27×60 W max (not included)	WW 48×E27×60 W max (not included)
USA 4×E26×60 W max (not included)	USA 8×E26×60 W max (not included)	USA 12×E26×60 W max (not included)	USA 48×E26×60 W max (not included)

VE 809/PL 48



VE 808/PL8+4

VE 808/PL3 40 CE VE 808/PL3 50 CE VE 808/PL8+4 CE VE 808/PL16 CE



Ø 40 cm / 15.75"
H 25 cm / 9.84"
W 15 kg / 33.06 lb
WW 3×E14×40 W max (not included)
USA 3×E12×40 W max (not included)

Ø 50 cm / 19.69"
H 30 cm / 11.81"
W 16 kg / 35.27 lb
WW 3×E14×40 W max (not included)
USA 3×E12×40 W max (not included)

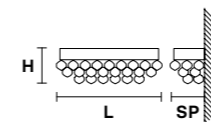
Ø 75 cm / 29.53"
H 35 cm / 13.78"
W 30 kg / 66.13 lb
WW 12×E27×60 W max (not included)
USA 12×E26×60 W max (not included)

Ø 100 cm / 39.37"
H 45 cm / 17.72"
W 50 kg / 110.23 lb
WW 16×E27×60 W max (not included)
USA 16×E26×60 W max (not included)

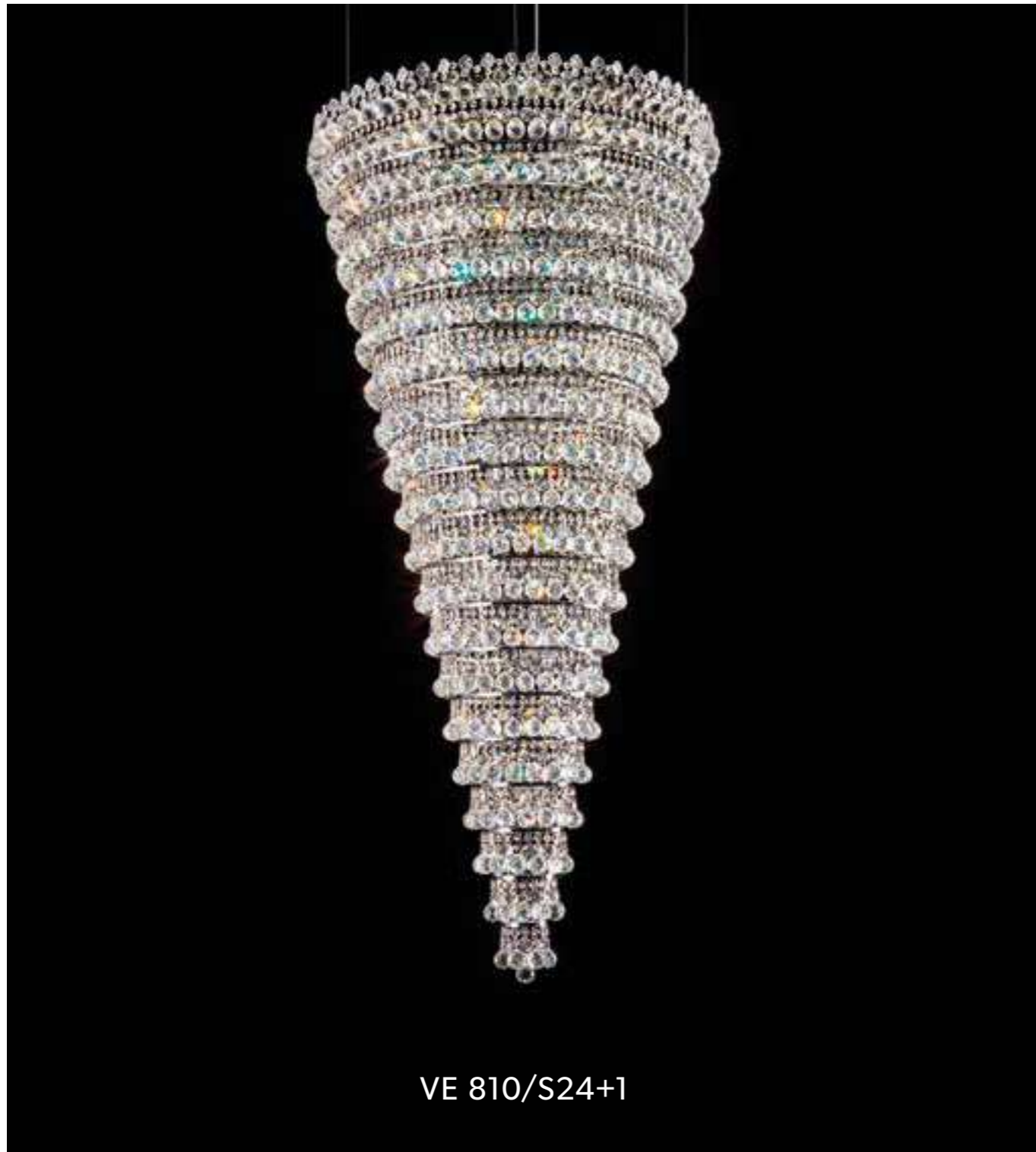


VE 809/A3

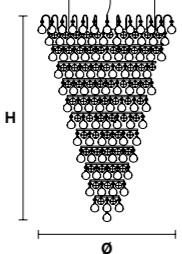
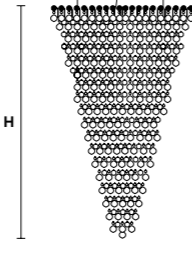
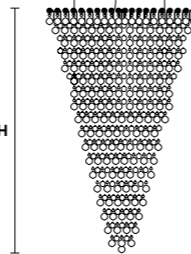
VE 809/A3 CE



L 40 cm / 15.75"
SP 14 cm / 5.51"
H 12 cm / 4.72"
W 7 kg / 15.43 lb
WW 3×G9×40W max (not included)
USA 3×G9×40W max (not included)



VE 810/S24+1

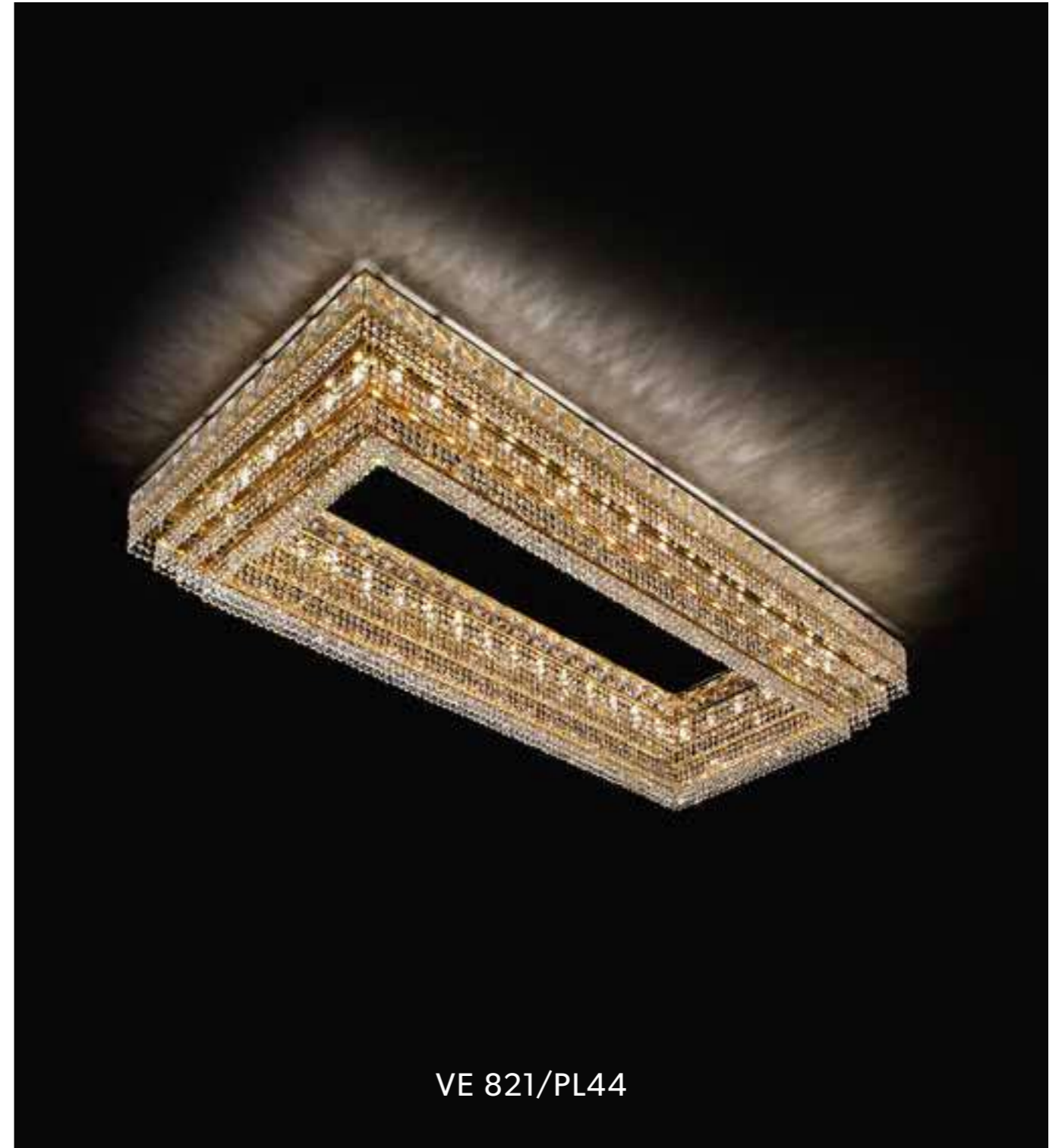
VE 810/S15+1	VE 810/S24+1	VE 810/S28+1
		
<p>Ø 60 cm / 23.62"</p> <p>H 100 cm / 39.37"</p> <p>W 45.5 kg / 100.3 lb</p>	<p>Ø 100 cm / 39.40"</p> <p>H 220 cm / 86.60"</p> <p>W 110 kg / 242.0 lb</p>	<p>Ø 120 cm / 47.24"</p> <p>H 250 cm / 98.43"</p> <p>W 230 kg / 507 lb</p>
<p>WW 15xE14x40 W max (not included)</p> <p>1xE27x60 W max (not included)</p> <p>USA 15xE12x40 W max (not included)</p> <p>1xE26x60 W max (not included)</p>	<p>WW 24xE14x40 W max (not included)</p> <p>1xE27x60 W max (not included)</p> <p>USA 24xE12x40 W max (not included)</p> <p>1xE26x60 W max (not included)</p>	<p>WW 28xE14x40 W max (not included)</p> <p>1xE27x60 W max (not included)</p> <p>USA 28xE12x40 W max (not included)</p> <p>1xE26x60 W max (not included)</p>



VE 810/S15+1

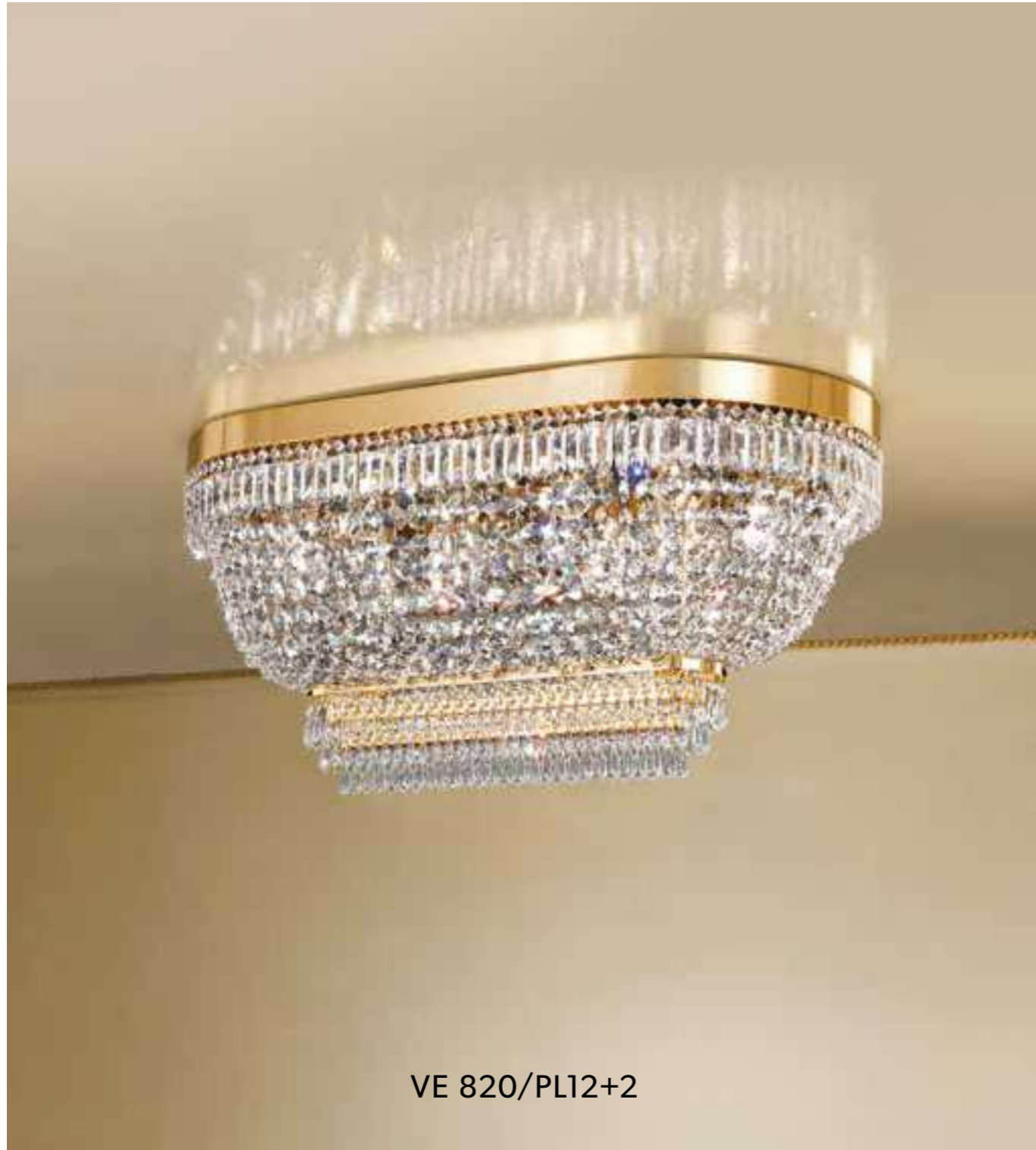


VE 821/PL24



VE 821/PL44

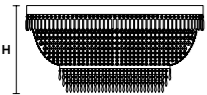
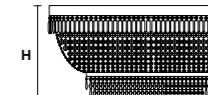
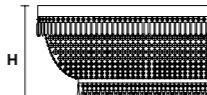
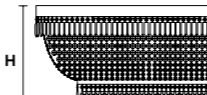
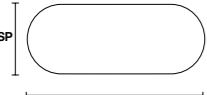

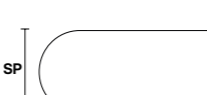
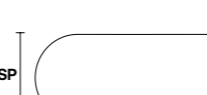
VE 821/PL24	CE	VE 821/PL28	CE	VE 821/PL32	CE	VE 821/PL44	CE
L 80 cm / 31.50"		L 110 cm / 43.30"		L 122 cm / 48.03"		L 166 cm / 65.35"	
SP 80 cm / 31.50"		SP 60 cm / 23.62"		SP 60 cm / 23.62"		SP 80 cm / 31.50"	
H 27 cm / 10.63"		H 27 cm / 10.63"		H 27 cm / 10.63"		H 27 cm / 10.63"	
W 26 kg / 57.32 lb		W 33 kg / 72.75 lb		W 40 kg / 88.18 lb		W 50 kg / 110.23 lb	
WW 24×E14×40 W max (not included)		WW 28×E14×40 W max (not included)		WW 32×E14×40 W max (not included)		WW 44×E14×40 W max (not included)	
USA 24×E12×40 W max (not included)		USA 28×E12×40 W max (not included)		USA 32×E12×40 W max (not included)		USA 44×E12×40 W max (not included)	

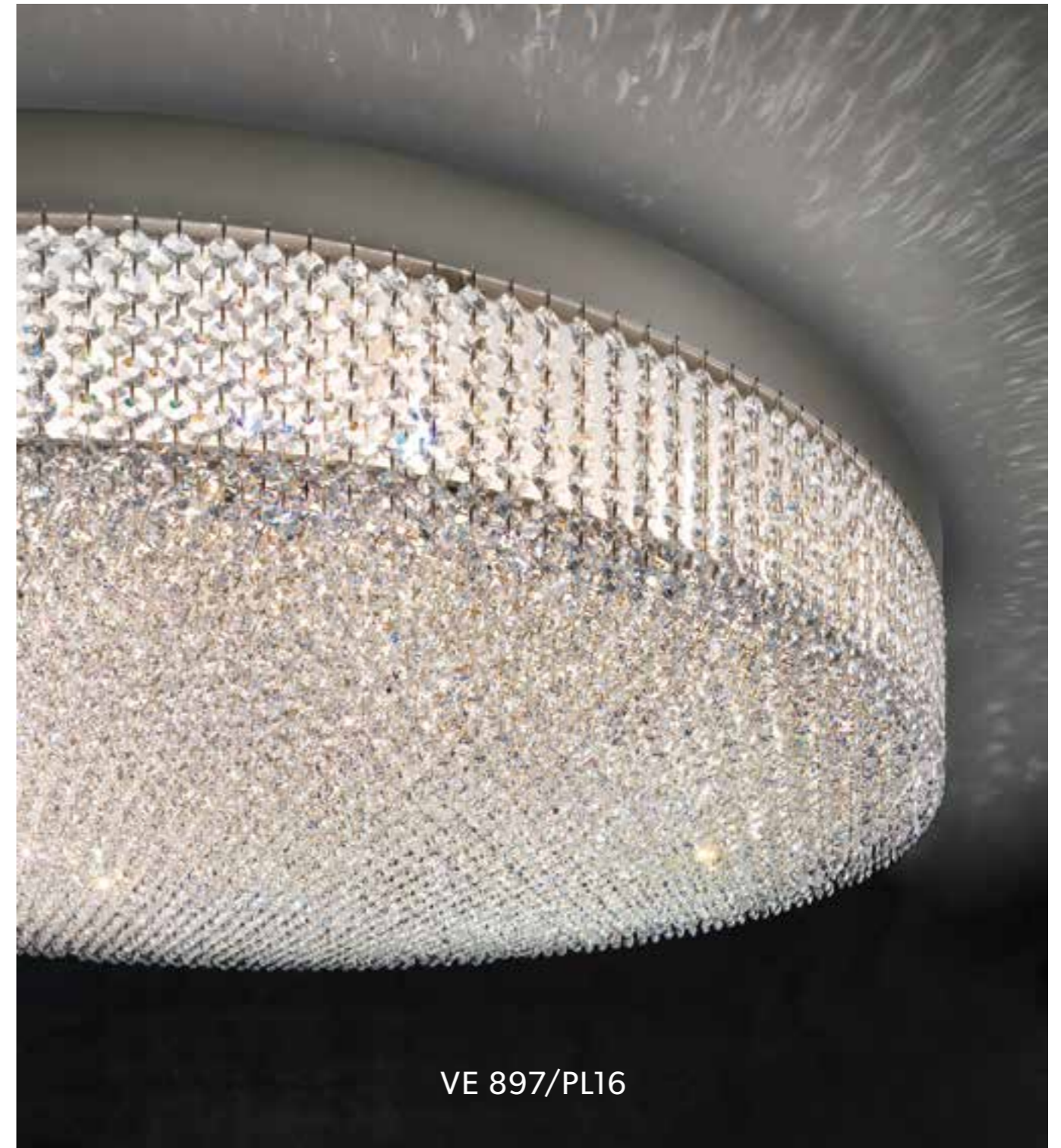


VE 820/PL12+2



VE 820/PL20

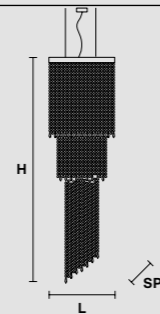
VE 820/PL10+2	CE	VE 820/PL12+2	CE	VE 820/PL20	CE	VE 820/PL26	CE
							
							
L 80 cm / 31.50"		L 100 cm / 39.37"		L 150 cm / 59.10"		L 200 cm / 78.74"	
SP 40 cm / 15.74"		SP 55 cm / 21.65"		SP 47 cm / 18.50"		SP 55 cm / 21.65"	
H 50 cm / 19.68"		H 50 cm / 19.69"		H 50 cm / 19.69"		H 50 cm / 19.69"	
W 25 kg / 55.11 lb		W 34 kg / 74.95 lb		W 50 kg / 110.2 lb		W 80 kg / 176.36 lb	
WW 2×E27×60 W max (not included) 10×E14×40 W max (not included)		WW 2×E27×60 W max (not included) 12×E14×40 W max (not included)		WW 2×E27×60 W max (not included) 18×E14×40 W max (not included)		WW 2×E27×60 W max (not included) 24×E14×40 W max (not included)	
USA 2×E26×60 W max (not included) 10×E12×40 W max (not included)		USA 2×E26×60 W max (not included) 12×E12×40 W max (not included)		USA 2×E26×60 W max (not included) 18×E12×40 W max (not included)		USA 2×E26×60 W max (not included) 24×E12×40 W max (not included)	



VE 897/PL4	CE	VE 897/PL6	CE	VE 897/PL8	CE	VE 897/PL16	CE
Ø 40 cm / 15.75"		Ø 60 cm / 23.70"		Ø 90 cm / 35.50"		Ø 120 cm / 47.25"	
H 20 cm / 7.90"		H 20 cm / 7.90"		H 20 cm / 7.90"		H 20 cm / 7.90"	
W 10 kg / 22.04 lb		W 15 kg / 33.06 lb		W 20 kg / 44.09 lb		W 26 kg / 57.32 lb	
WW 4×E27×60 W max (not included)		WW 6×E27×60 W max (not included)		WW 8×E27×60 W max (not included)		WW 16×E27×60 W max (not included)	
USA 4×E26×60 W max (not included)		USA 6×E26×60 W max (not included)		USA 8×E26×60 W max (not included)		USA 16×E26×60 W max (not included)	



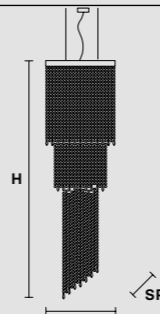
VE 814/12 50



L 50 cm / 19.69"
SP 50 cm / 19.69"
H 170 cm / 66.93"
W 28 kg / 61.72 lb

WW 12xE14x40 W max (not included)
USA 12xE12x40 W max (not included)

VE 814/16 75

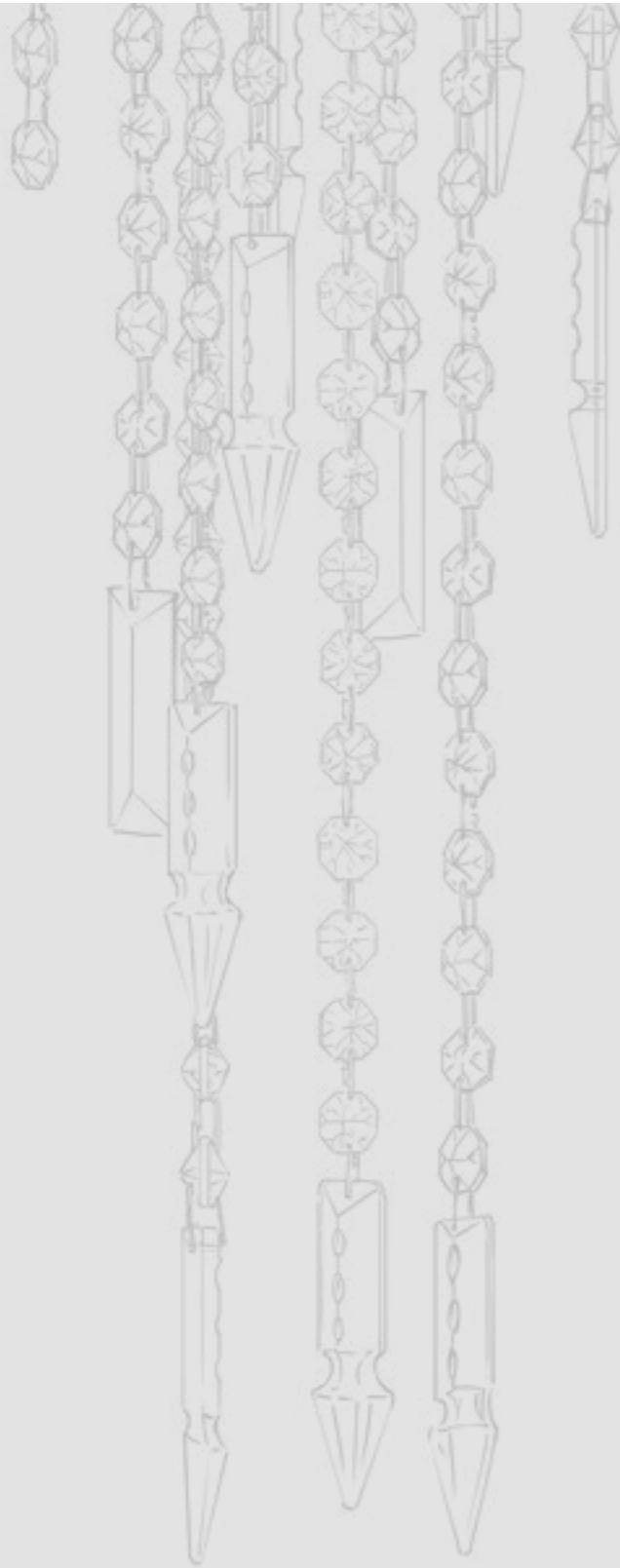


L 75 cm / 29.53"
SP 75 cm / 29.53"
H 200 cm / 78.74"
W 50 kg / 110.23 lb

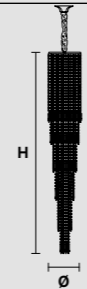
WW 16xE14x40 W max (not included)
USA 16xE12x40 W max (not included)



VE 814/12 50



VE 825 /S6 CE



Ø 30 cm / 11.81"
 H 230 cm / 90.55"
 W 22 kg / 48.50 lb

 WW 6×E27×60 W max (not included)
 USA 6×E26×40 W max (not included)



VE 825/S6

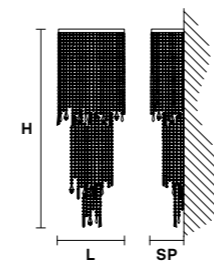


VE 825/A8 G



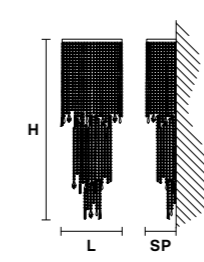
VE 825/A8 M

VE 825/A8 G Ⓒ VE 825/A8 M Ⓒ



L 30 cm / 11.81"
SP 13 cm / 5.12"
H 100 cm / 39.37"
W 6 kg / 13.22 lb

WW 8×G9×40W max (not included)
USA 8×G9×40W max (not included)



L 25 cm / 9.84"
SP 12 cm / 4.72"
H 70 cm / 27.56"
W 4 kg / 8.81 lb

WW 8×G9×40W max (not included)
USA 8×G9×40W max (not included)

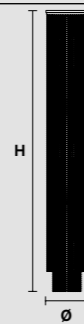


VE 840/PL8

CE

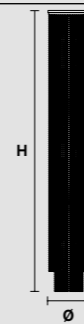
VE 840/PL12

CE



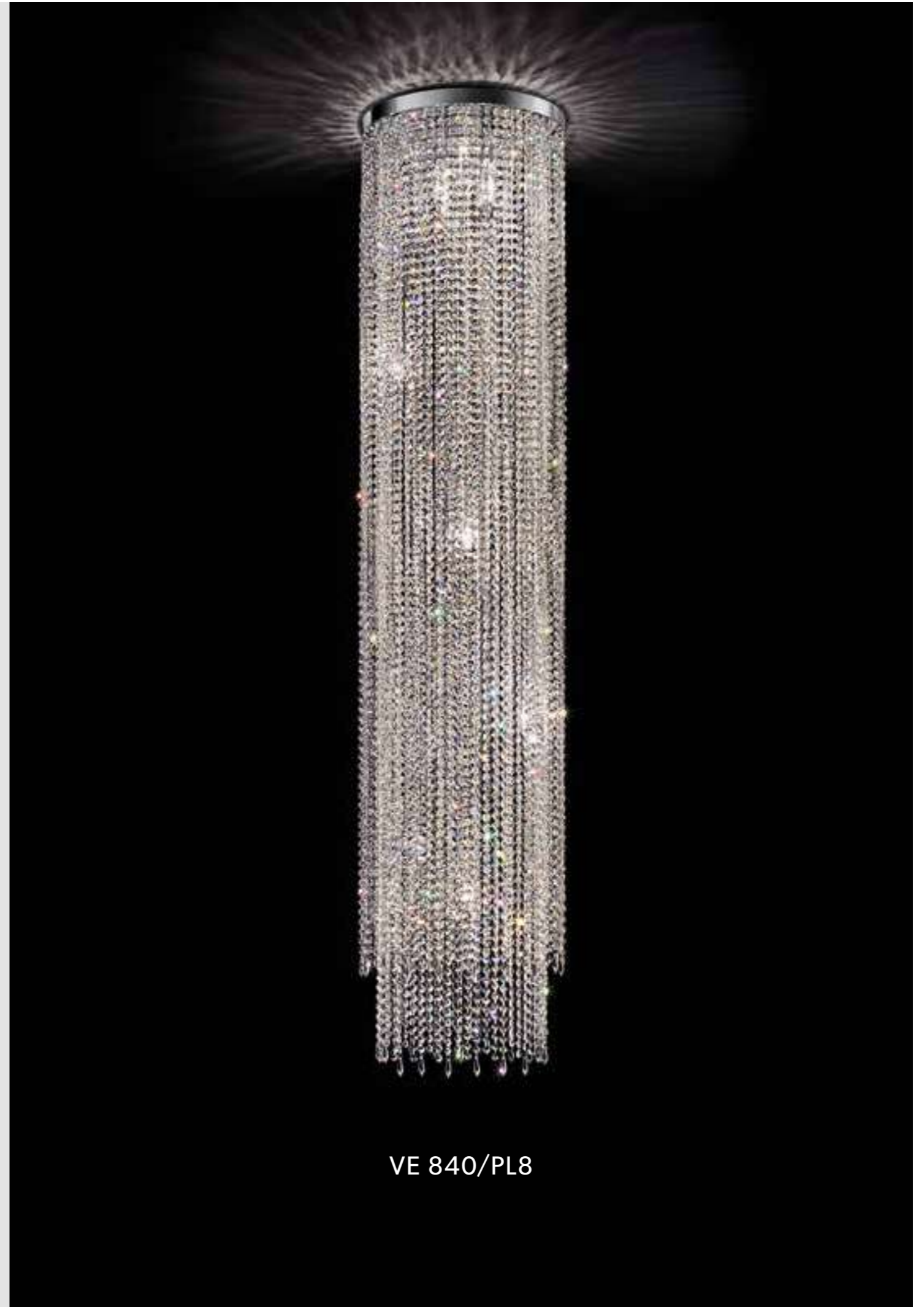
Ø 40 cm / 15.60"
H 200 cm / 78.75"
W 27 kg / 59.40 lb

WW 8×E14×40 W max (not included)
USA 8×E12×40 W max (not included)

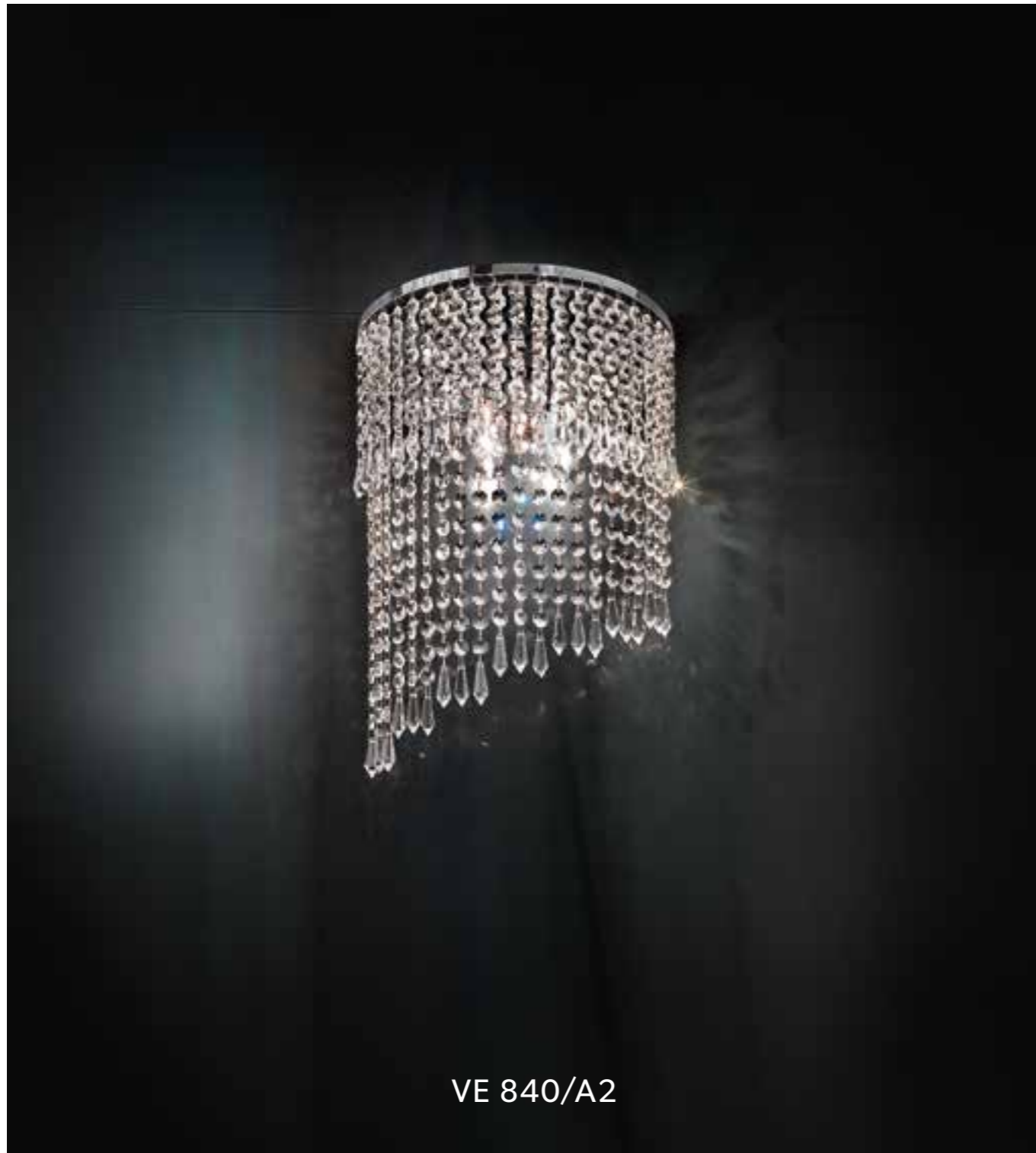


Ø 60 cm / 23.70"
H 200 cm / 78.74"
W 40 kg / 88.00 lb

WW 12×E14×40 W max (not included)
USA 12×E12×40 W max (not included)



VE 840/PL8



VE 840/A2

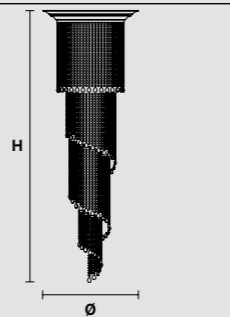


VE 840/PL6

VE 840/A2	CE	VE 840/PL4	CE	VE 840/PL6	CE
L 30 cm / 11.81" SP 13 cm / 5.12" H 40 cm / 15.75" W 2 kg / 4.40 lb		Ø 29 cm / 11.42" H 80 cm / 31.50" W 4 kg / 8.81 lb		Ø 37 cm / 14.57" H 90 cm / 35.43" W 5 kg / 11.02 lb	
WW 2×E14×40 W max (not included) USA 2×E12×40 W max (not included)		WW 1×E27×60 W max (not included) 3×E14×40 W max (not included) USA 1×E26×60 W max (not included) 3×E12×40 W max (not included)		WW 1×E27×60 W max (not included) 5×E14×40 W max (not included) USA 1×E26×60 W max (not included) 5×E12×40 W max (not included)	



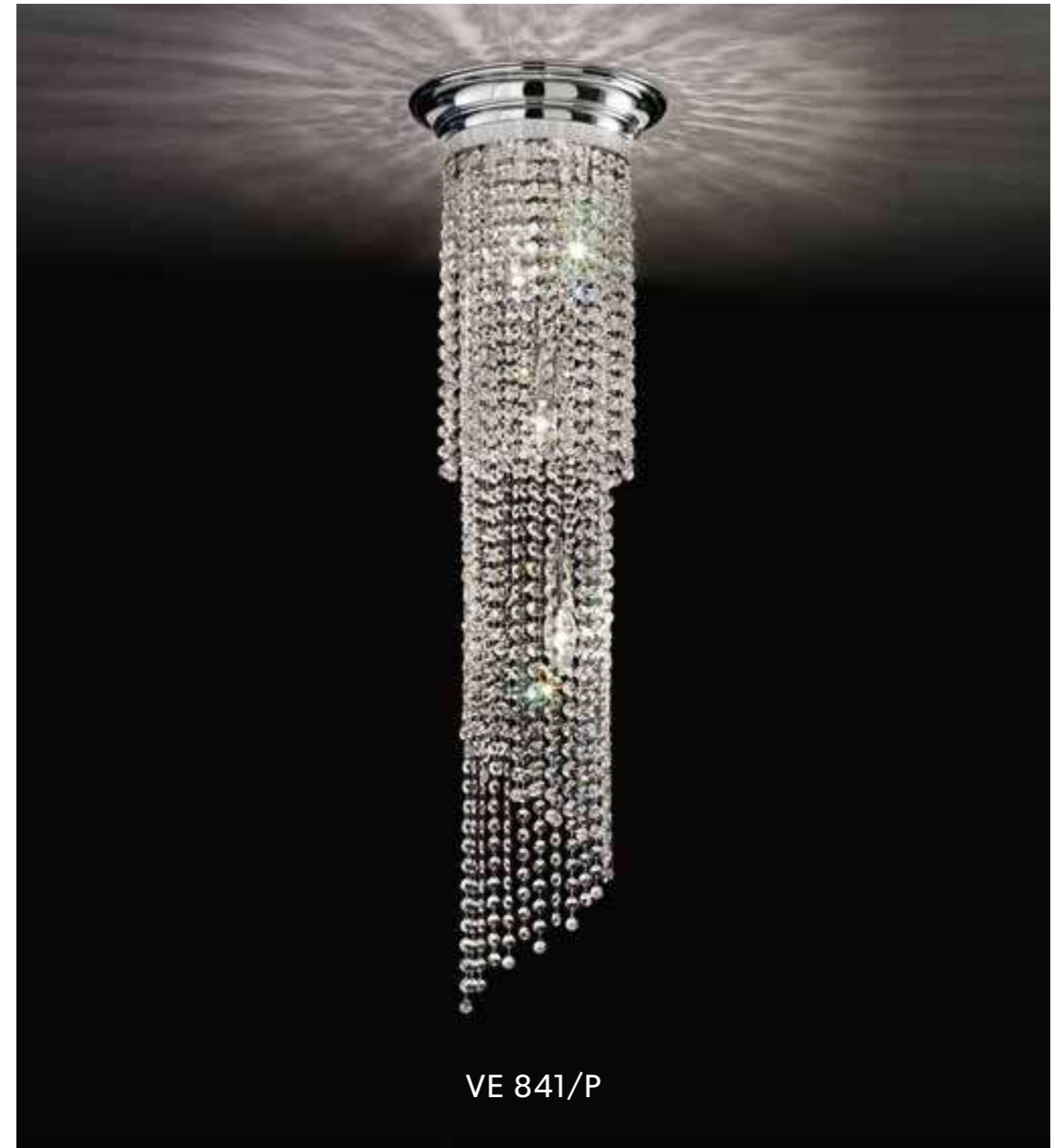
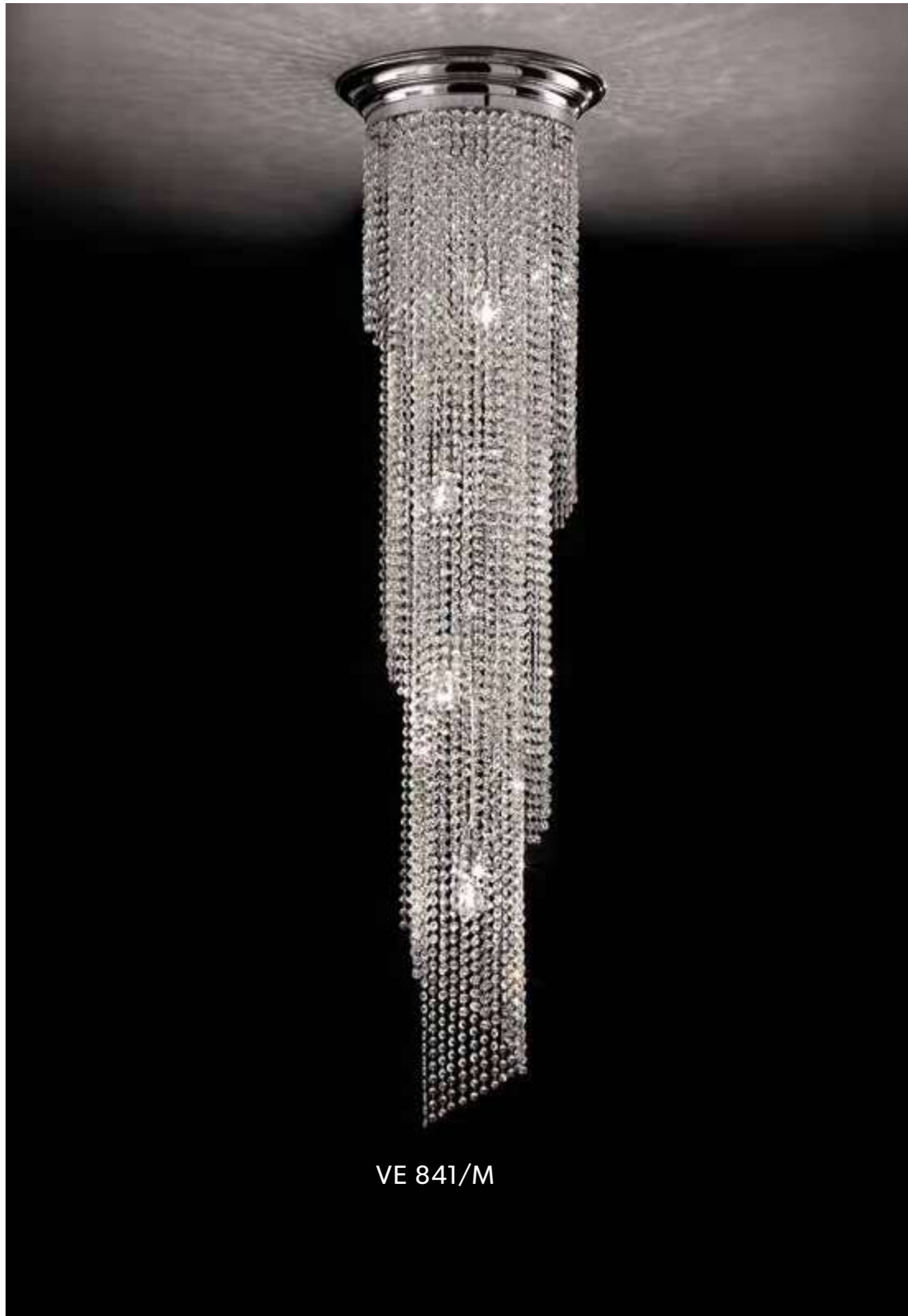
VE 841/G CE



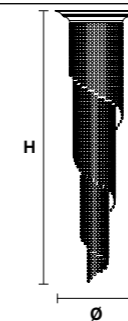
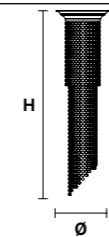
- Ø 77 cm / 30.31"
- H 200 cm / 78.74"
- W 28 kg / 61.72 lb
- WW 13×E27×60 W max (not included)
- USA 13×E26×60 W max (not included)



VE 841/G

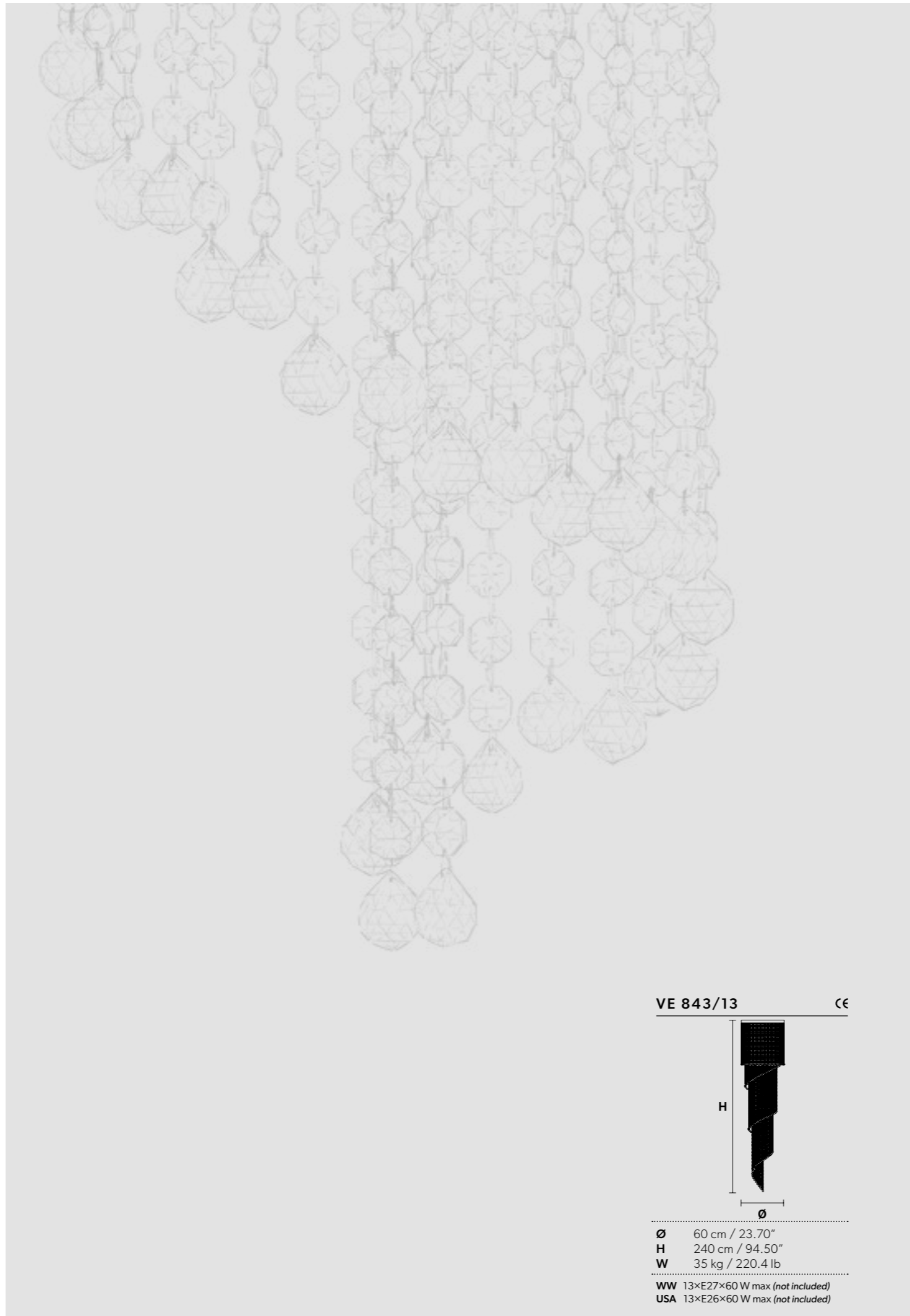


VE 841/P CE VE 841/M CE




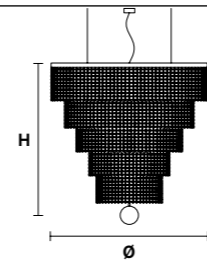
Ø 27 cm / 10.63"
H 100 cm / 39.37"
W 4 kg / 8.81 lb
WW 3×E14×40 W max (not included)
USA 3×E12×40 W max (not included)

Ø 44 cm / 17.50"
H 170 cm / 67.00"
W 14 kg / 30.86 lb
WW 4×E14×40 W max (not included)
USA 4×E12×40 W max (not included)





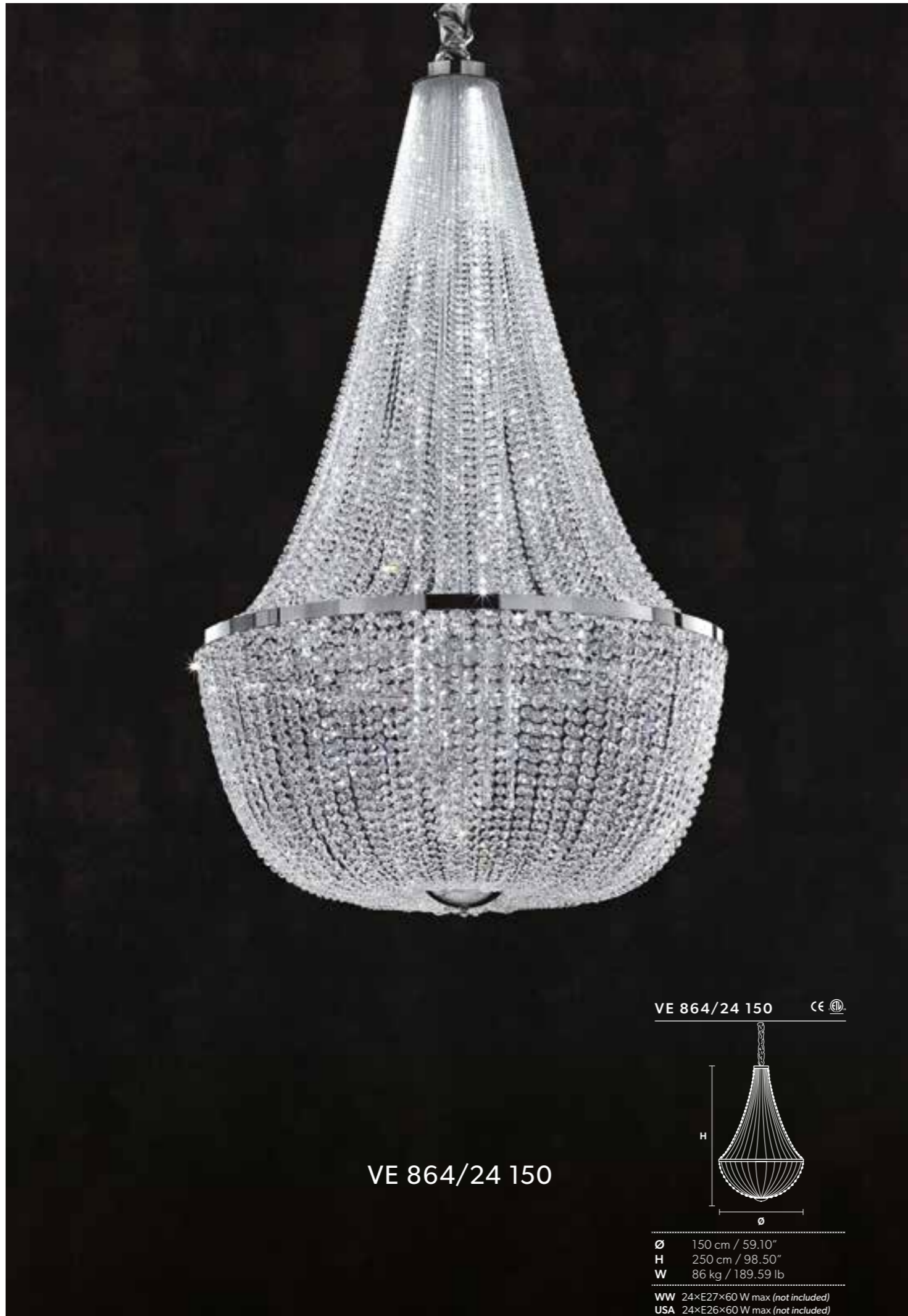
VE 845/16+1 




- Ø 120 cm / 47.25"
 - H 110 cm / 43.30"
 - W 35 kg / 77.16 lb
-
- WW 17×E27×60 W max (not included)
 USA 17×E26×60 W max (not included)



VE 845/16+1



VE 864/24 150 




VE 864/24 150

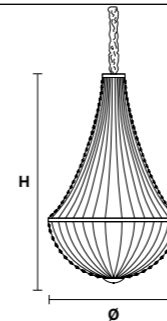
Ø 150 cm / 59.10"
H 250 cm / 98.50"
W 86 kg / 189.59 lb

WW 24×E27×60 W max (not included)
USA 24×E26×60 W max (not included)




VE 864/A4

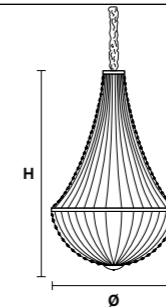
VE 864/20 120 



Ø 120 cm / 47.30"
H 200 cm / 78.75"
W 53 kg / 116.84 lb


WW 20×E27×60 W max (not included)
USA 20×E26×60 W max (not included)

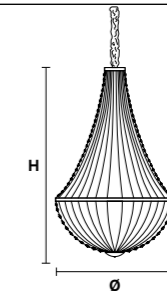
VE 864/14 90 



Ø 90 cm / 35.50"
H 150 cm / 59.10"
W 37.5 kg / 82.67 lb

WW 14×E27×60 W max (not included)
USA 14×E26×60 W max (not included)

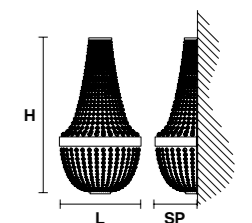
VE 864/10 60 



Ø 60 cm / 23.70"
H 110 cm / 43.31"
W 23 kg / 50.70 lb

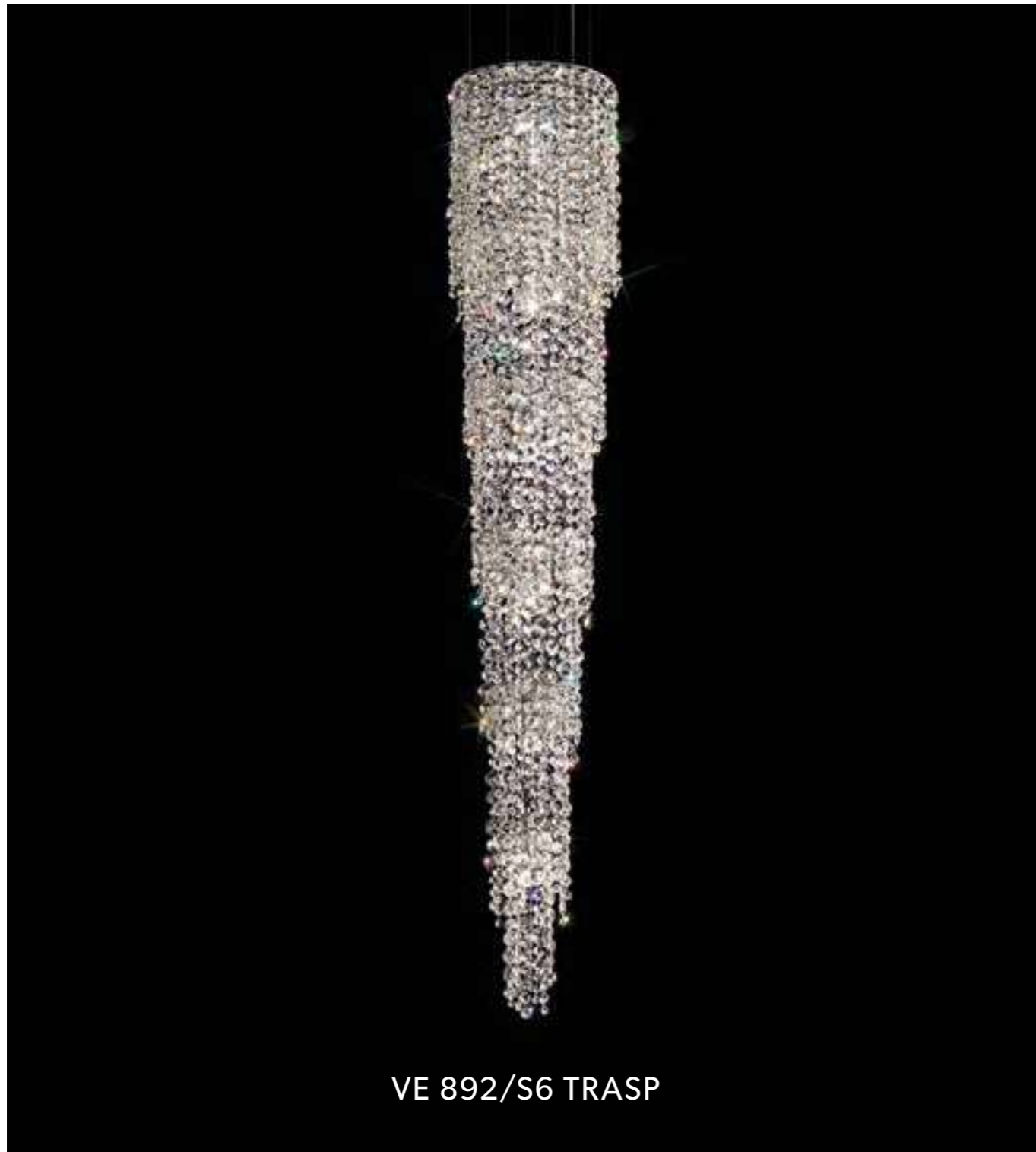
WW 10×E27×60 W max (not included)
USA 10×E26×60 W max (not included)

VE 864/A4 



L 30 cm / 11.80"
SP 21 cm / 8.30"
H 57 cm / 22.45"
W 4 kg / 8.81 lb

WW 4×E14×40 W max (not included)
USA 4×E12×40 W max (not included)



VE 892/S6 TRASP



VE 892/S6

VE 892/S6 TRASP CE 	VE 892/S6 CE
<p>Ø 30 cm / 11.80"</p> <p>H 180 cm / 70.90"</p> <p>W 20 kg / 44.09 lb</p>	<p>Ø 30 cm / 11.80"</p> <p>H 180 cm / 70.90"</p> <p>W 20 kg / 44.09 lb</p>
<p>WW 6×E27×60 W max (not included)</p> <p>USA 6×E26×60 W max (not included)</p>	<p>WW 6×E27×60 W max (not included)</p> <p>USA 6×E26×60 W max (not included)</p>




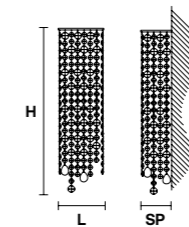
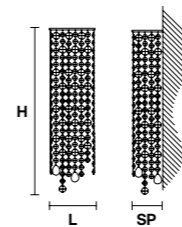
VE 892/A2 TRASP



VE 892/A2

VE 892/A2 TRASP 

VE 892/A2 



L 15 cm / 6.00"
SP 12 cm / 4.80"
H 70 cm / 27.60"
W 3 kg / 6.61 lb

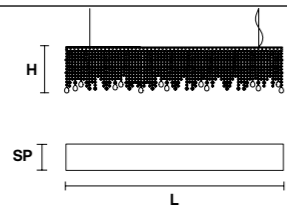
WW 2×E14×40 W max (not included)
USA 2×E12×40 W max (not included)

L 15 cm / 6.00"
SP 12 cm / 4.80"
H 70 cm / 27.60"
W 3 kg / 6.61 lb

WW 2×E14×40 W max (not included)
USA 2×E12×40 W max (not included)

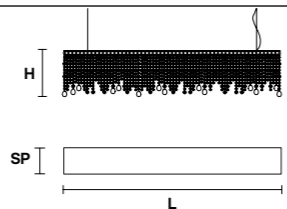


VE 895/S6 




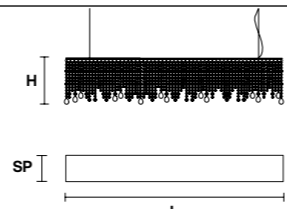
L	126 cm / 49.60"
SP	15 cm / 5.90"
H	40 cm / 15.75"
W	17 kg / 37.47 lb
WW	6×E14×40 W max (not included)
USA	6×E12×40 W max (not included)

VE 895/S8 



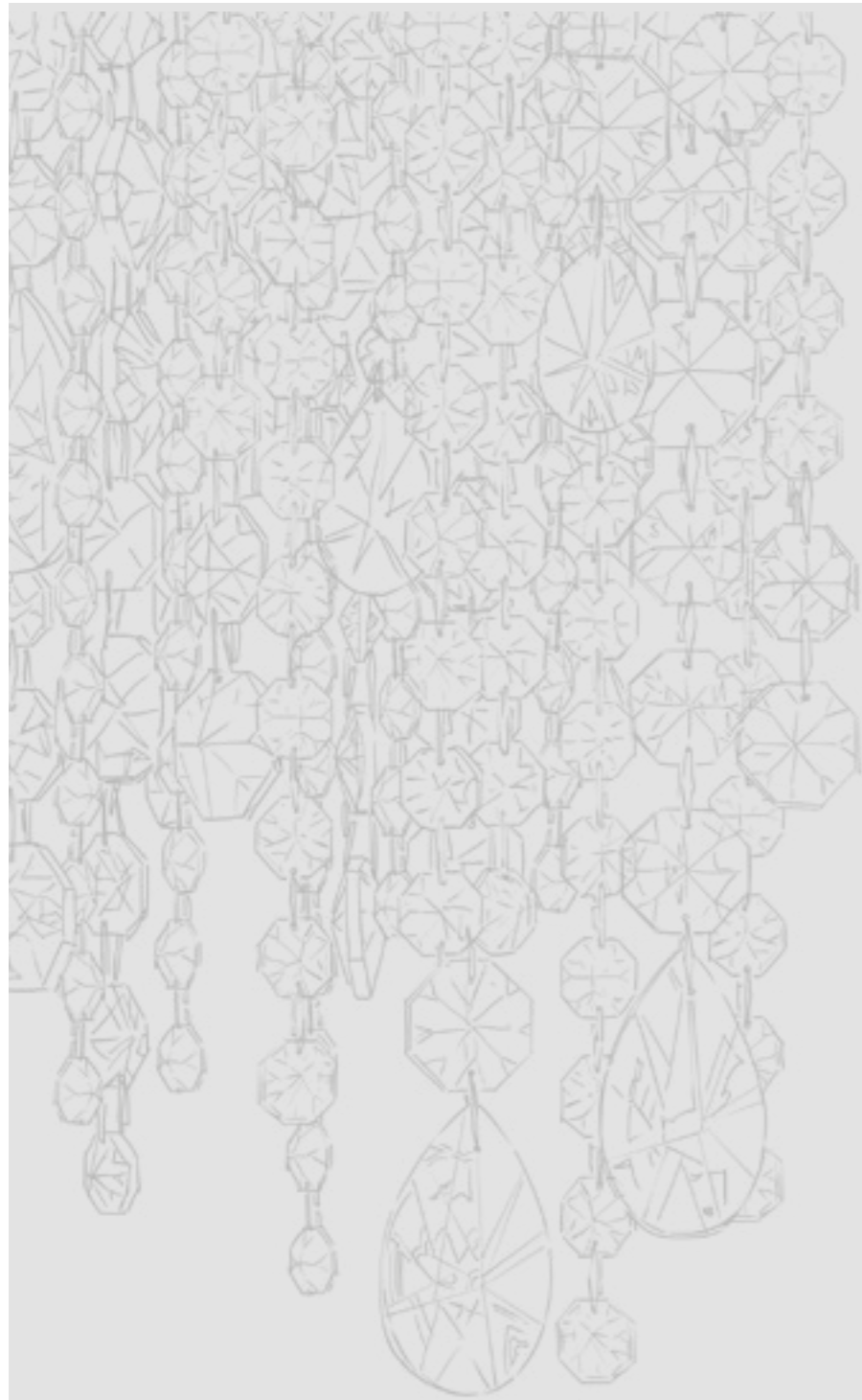
L	160 cm / 63.00"
SP	15 cm / 5.90"
H	40 cm / 15.75"
W	23 kg / 50.70 lb
WW	8×E14×40 W max (not included)
USA	8×E12×40 W max (not included)

VE 895/S10 

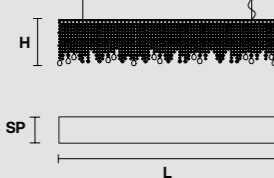


L	200 cm / 78.75"
SP	15 cm / 5.90"
H	40 cm / 15.75"
W	32 kg / 70.54 lb
WW	10×E14×40 W max (not included)
USA	10×E12×40 W max (not included)

VE 895/S6



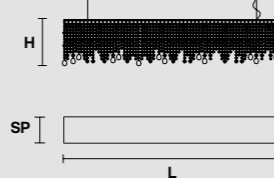
VE 895/S6 TR 



L 126 cm / 49.60"
SP 15 cm / 5.90"
H 40 cm / 15.75"
W 17 kg / 37.47 lb

WW 6×E14×40 W max (not included)
USA 6×E12×40 W max (not included)

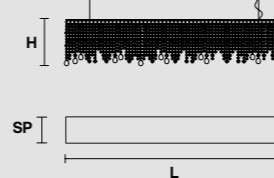
VE 895/S8 TR 



L 160 cm / 63.00"
SP 15 cm / 5.90"
H 40 cm / 15.75"
W 23 kg / 50.70 lb

WW 8×E14×40 W max (not included)
USA 8×E12×40 W max (not included)

VE 895/S10 TR 



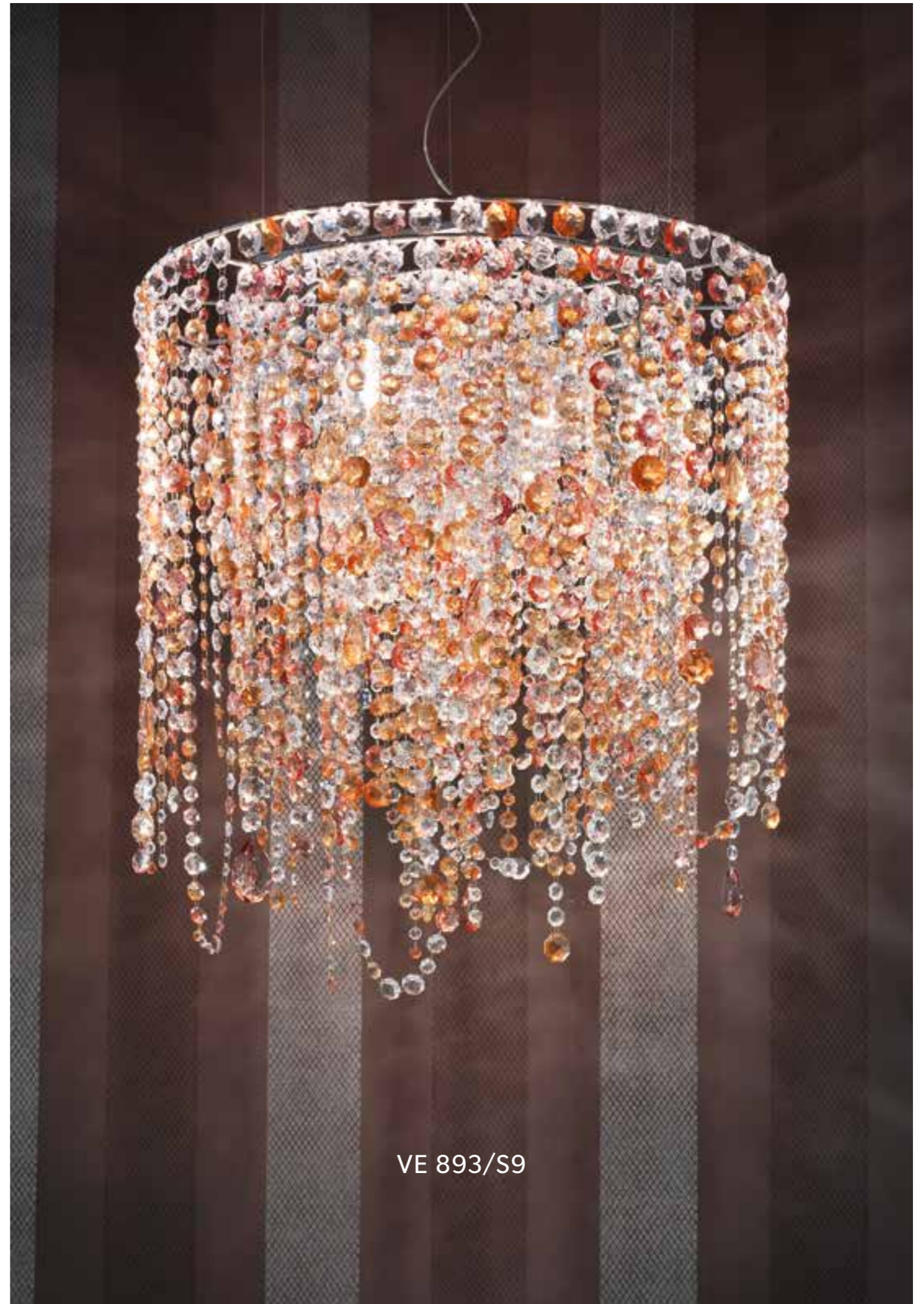
L 200 cm / 78.75"
SP 15 cm / 5.90"
H 40 cm / 15.75"
W 32 kg / 70.54 lb

WW 10×E14×40 W max (not included)
USA 10×E12×40 W max (not included)

VE 895/S6 TR



VE 893/S9 TR

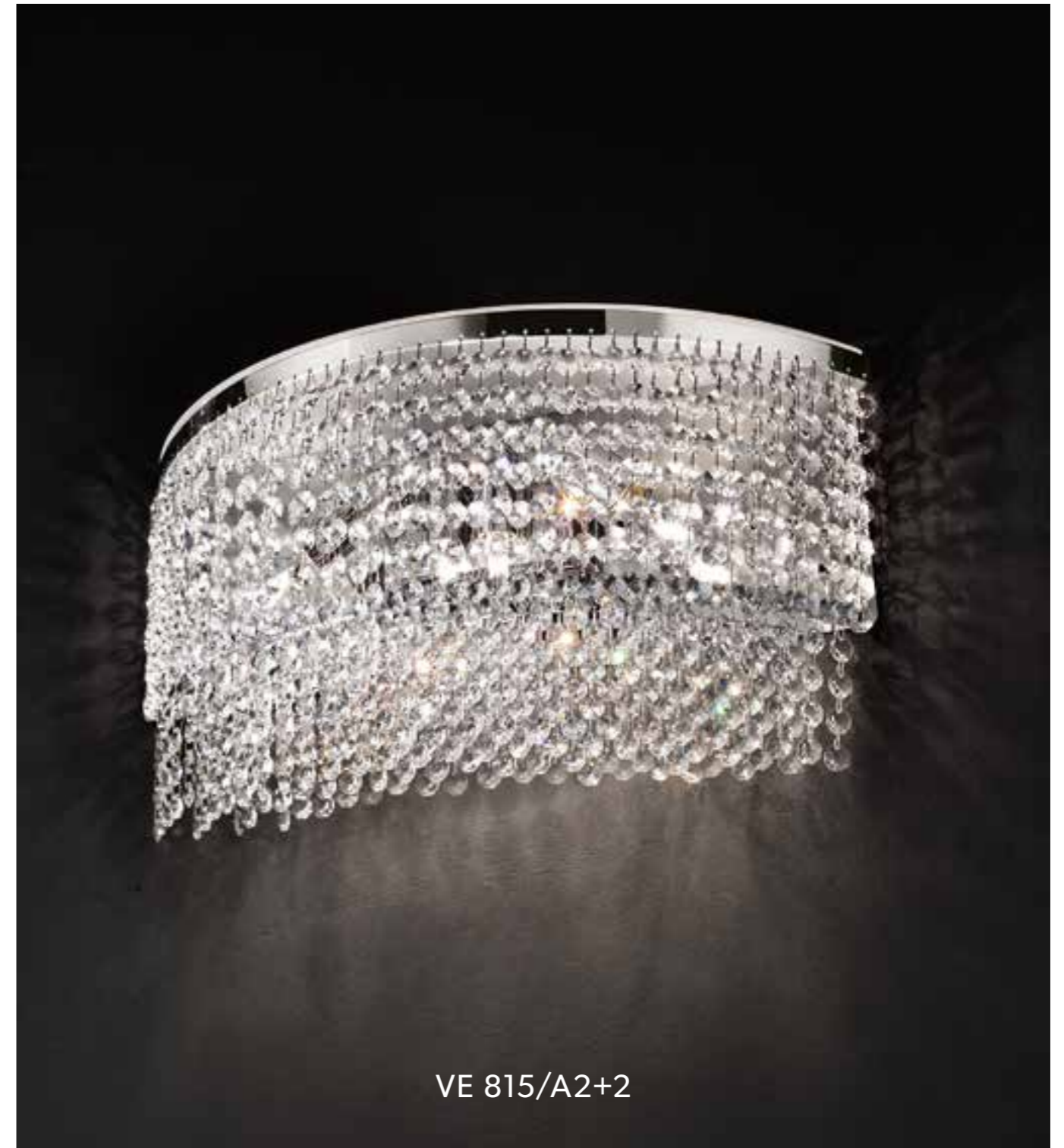


VE 893/S9

VE 893/S9	CE	VE 893/S9 TR	CE
<p>Ø 70 cm / 27.60"</p> <p>H 80 cm / 31.50"</p> <p>W 25 kg / 55.11 lb</p>		<p>Ø 70 cm / 27.60"</p> <p>H 80 cm / 31.50"</p> <p>W 25 kg / 55.11 lb</p>	
<p>WW 9×E27×60 W max (not included)</p> <p>USA 9×E26×60 W max (not included)</p>		<p>WW 9×E27×60 W max (not included)</p> <p>USA 9×E26×60 W max (not included)</p>	

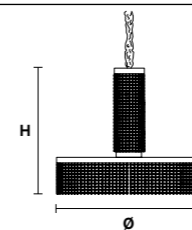


VE 815/12+1



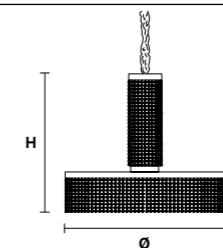
VE 815/A2+2

VE 815/10+1 Ⓒ VE 815/12+1 Ⓒ VE 815/A2 Ⓒ VE 815/A2+2 Ⓒ



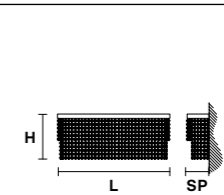
Ø 80 cm / 31.50"
H 90 cm / 35.43"
W 16 kg / 35.27 lb

WW 10xG9x40 W max (not included)
1xE27 PAR30x60 W max (not included)
USA 10xG9x40 W max (not included)
1xE26 PAR30x60 W max (not included)



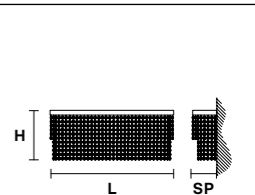
Ø 100 cm / 39.37"
H 90 cm / 35.43"
W 18 kg / 39.68 lb

WW 10xG9x40 W max (not included)
1xE27 PAR30x60 W max (not included)
USA 10xG9x40 W max (not included)
1xE26 PAR30x60 W max (not included)



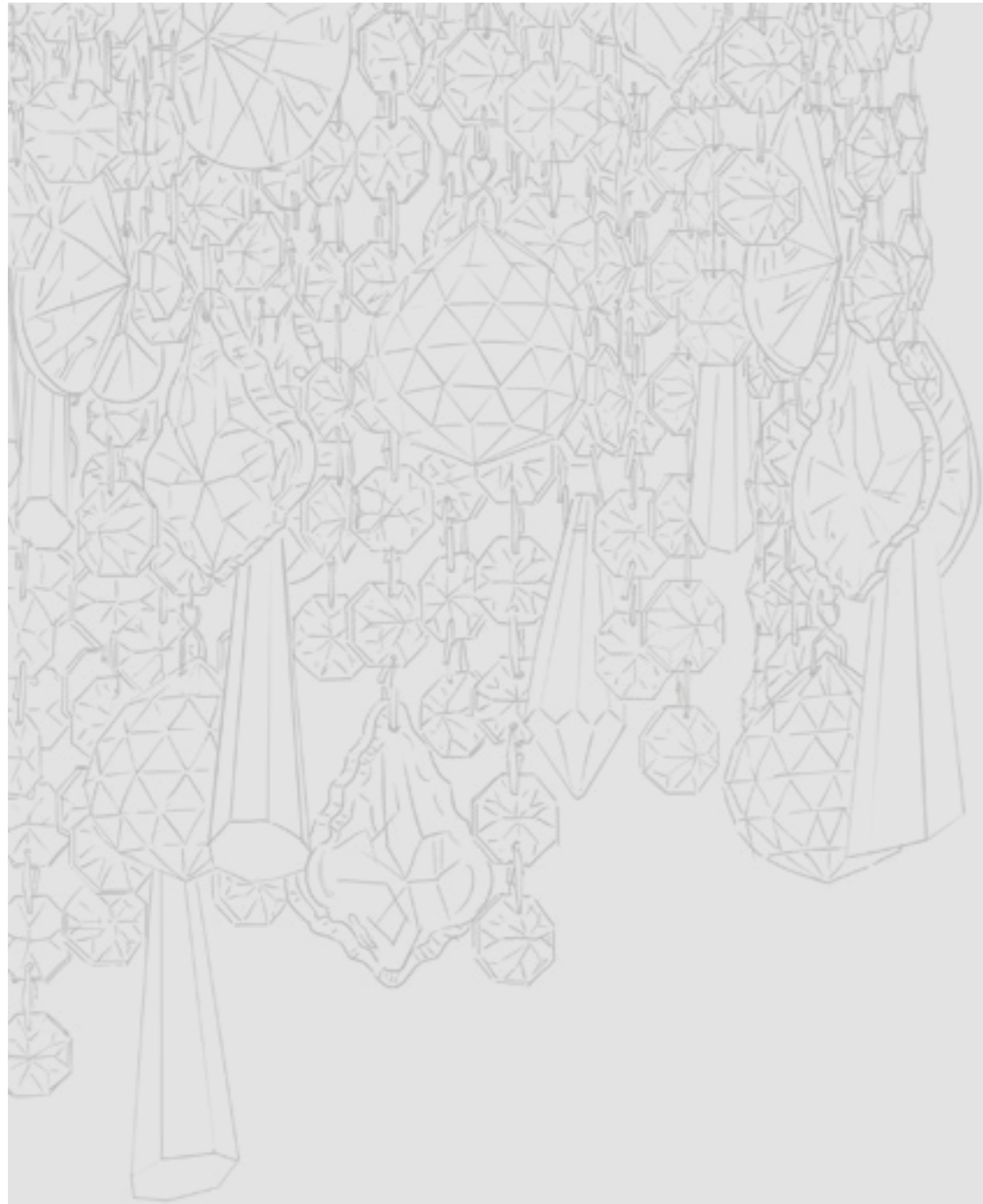
L 30 cm / 11.81"
SP 14 cm / 5.51"
H 20 cm / 7.87"
W 2.5 kg / 5.51 lb

WW 2xG9x40 W max (not included)
USA 2xG9x40 W max (not included)



L 48 cm / 18.90"
SP 14 cm / 5.51"
H 24 cm / 9.45"
W 5 kg / 11.02 lb

WW 2xG9x40 W max (not included)
2xE14x40 W max (not included)
USA 2xG9x40 W max (not included)
2xE12x40 W max (not included)

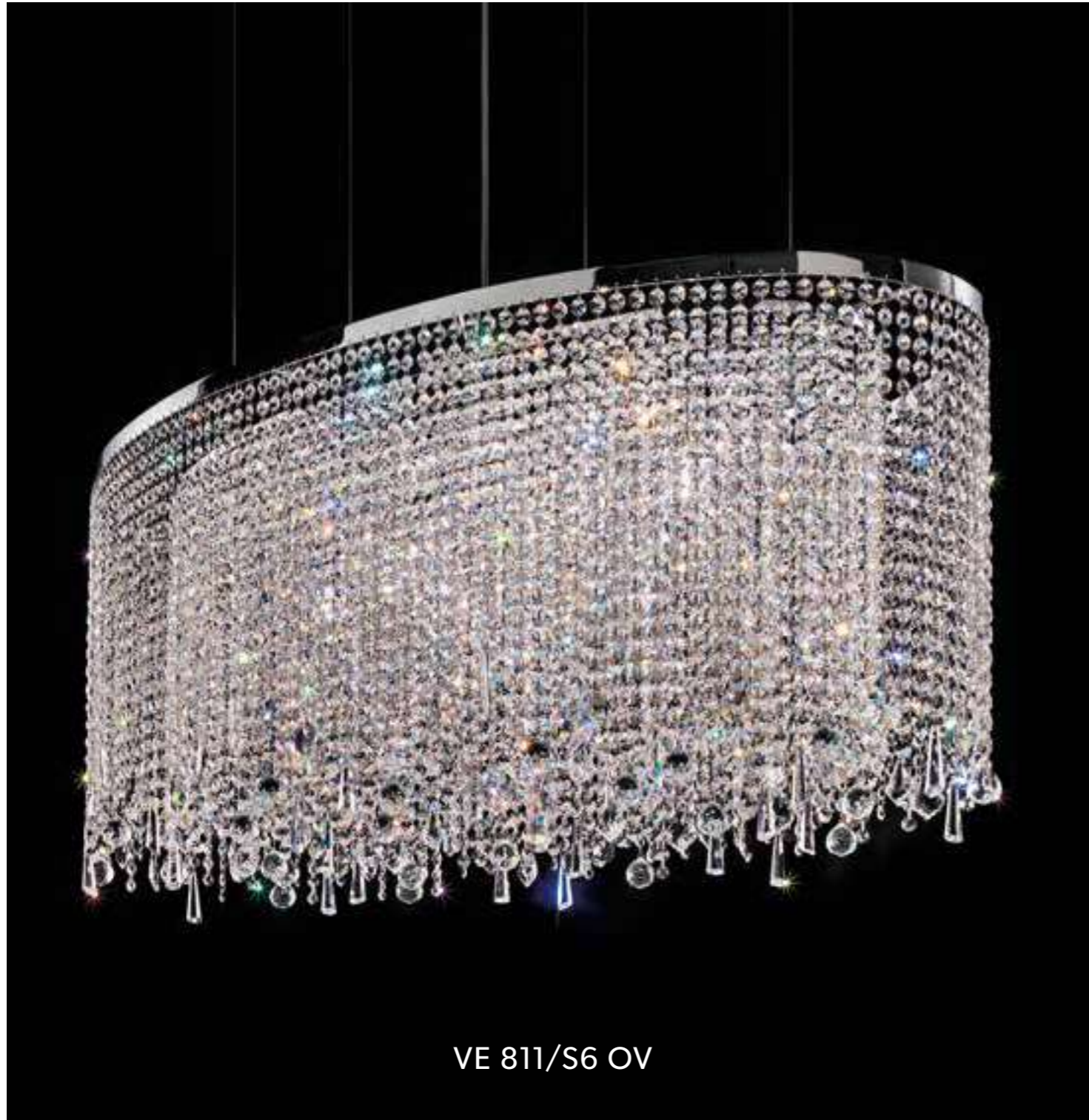


VE 811/S3 RD	VE 811/S8 RD	VE 811/S10 RD	VE 811/S12 RD
<p>Ø 40 cm / 15.60"</p> <p>H 30 cm / 11.80"</p> <p>W 4 kg / 8.80 lb</p>	<p>Ø 60 cm / 23.70"</p> <p>H 40 cm / 15.60"</p> <p>W 8 kg / 17.60 lb</p>	<p>Ø 80 cm / 31.50"</p> <p>H 50 cm / 19.70"</p> <p>W 15 kg / 33.00 lb</p>	<p>Ø 100 cm / 39.40"</p> <p>H 60 cm / 23.70"</p> <p>W 28 kg / 61.60 lb</p>
<p>WW 3×E14×40 W max (not included)</p> <p>USA 3×E12×40 W max (not included)</p>	<p>WW 8×E27×60 W max (not included)</p> <p>USA 8×E26×60 W max (not included)</p>	<p>WW 10×E27×60 W max (not included)</p> <p>USA 10×E26×60 W max (not included)</p>	<p>WW 12×E27×60 W max (not included)</p> <p>USA 12×E26×60 W max (not included)</p>

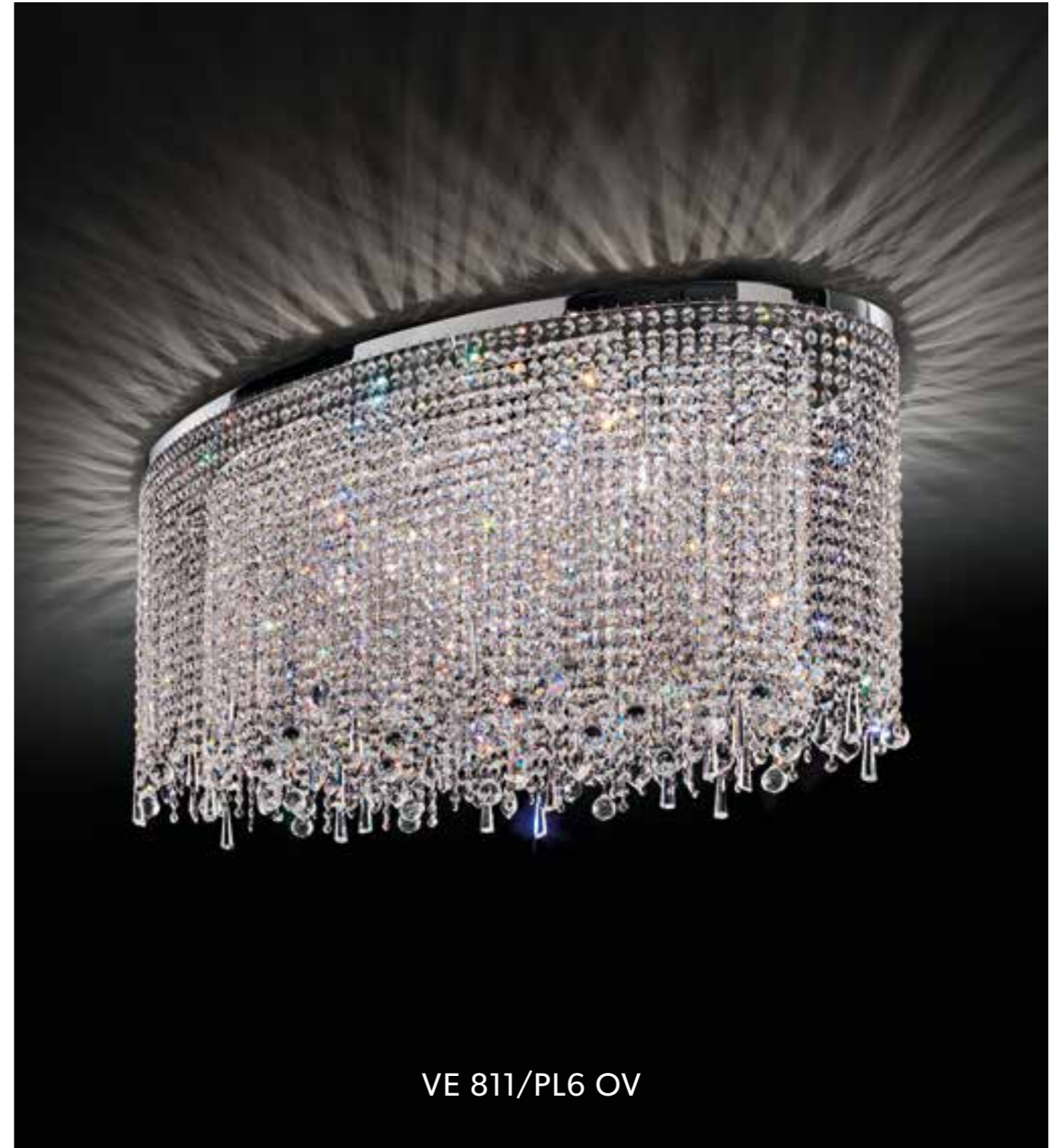


VE 811/PL3 RD	CE	VE 811/PL8 RD	CE	VE 811/PL10 RD	CE	VE 811/PL12 RD	CE
<p>Ø 40 cm / 15.60"</p> <p>H 30 cm / 11.80"</p> <p>W 4 kg / 8.80 lbb</p>		<p>Ø 60 cm / 23.70"</p> <p>H 40 cm / 15.60"</p> <p>W 8 kg / 17.60 lb</p>		<p>Ø 80 cm / 31.50"</p> <p>H 50 cm / 19.70"</p> <p>W 15 kg / 33.06 lb</p>		<p>Ø 100 cm / 39.40"</p> <p>H 60 cm / 23.70"</p> <p>W 28 kg / 61.60 lb</p>	
<p>WW 3×E14×40 W max (not included)</p> <p>USA 3×E12×40 W max (not included)</p>		<p>WW 8×E27×60 W max (not included)</p> <p>USA 8×E26×60 W max (not included)</p>		<p>WW 10×E27×60 W max (not included)</p> <p>USA 10×E26×60 W max (not included)</p>		<p>WW 12×E27×60 W max (not included)</p> <p>USA 12×E26×60 W max (not included)</p>	

VE 811/PL12 RD



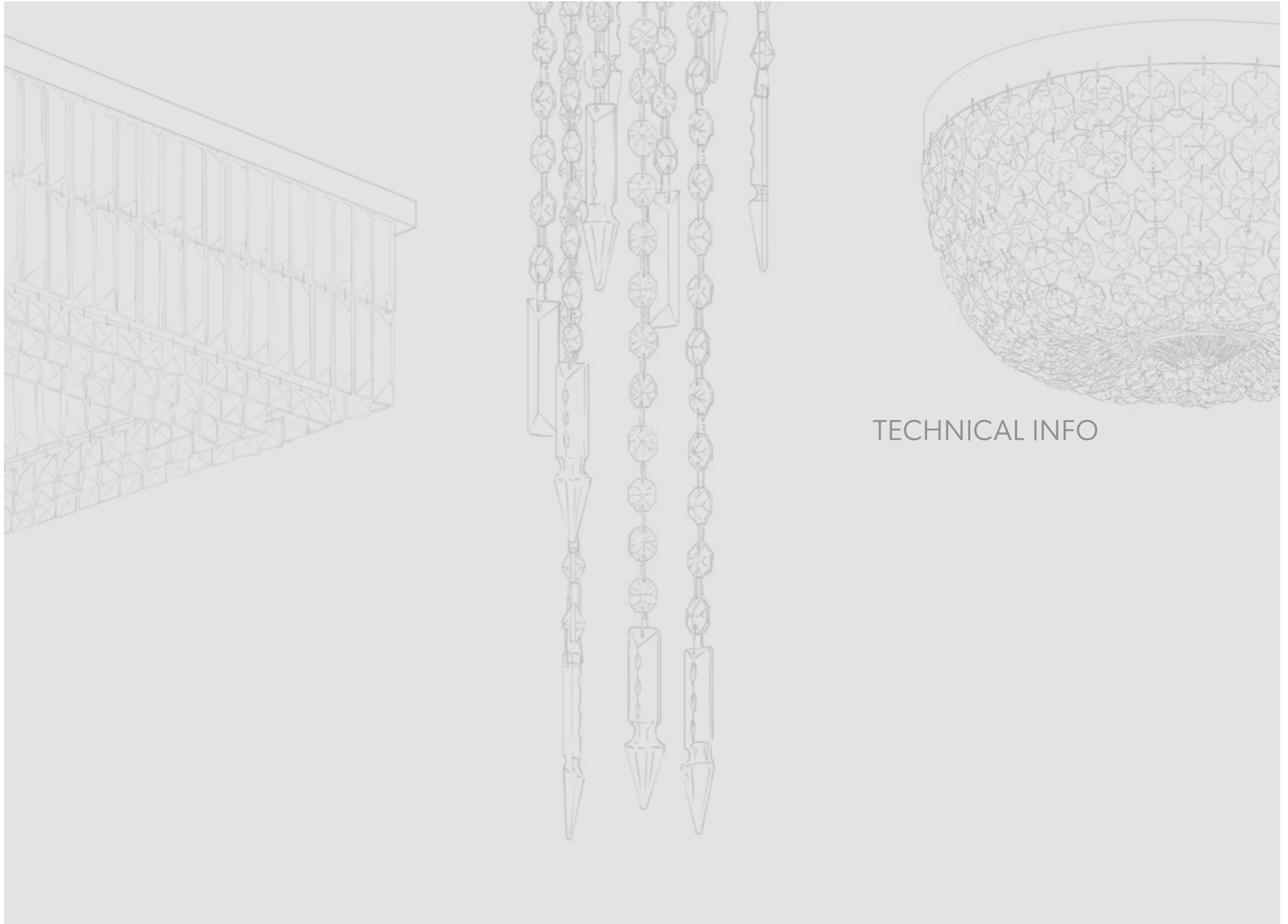
VE 811/S6 OV



VE 811/PL6 OV

VE 811/S4 OV	VE 811/S5 OV	VE 811/S6 OV
L 80 cm / 31.50"	L 100 cm / 39.40"	L 120 cm / 47.30"
SP 40 cm / 15.60"	SP 40 cm / 15.70"	SP 60 cm / 23.70"
H 30 cm / 11.80"	H 40 cm / 15.70"	H 50 cm / 19.70"
W 9 kg / 19.80 lb	W 12 kg / 26.40 lb	W 16 kg / 35.20 lb
WW 4x E27x60 W max (not included) USA 4x E26x60 W max (not included)	WW 5x E27x60 W max (not included) USA 5x E26x60 W max (not included)	WW 6x E27x60 W max (not included) USA 6x E26x60 W max (not included)

VE 811/PL4 OV	VE 811/PL5 OV	VE 811/PL6 OV
L 80 cm / 31.50"	L 100 cm / 39.40"	L 120 cm / 47.30"
SP 40 cm / 15.60"	SP 40 cm / 15.70"	SP 60 cm / 23.70"
H 30 cm / 11.80"	H 40 cm / 15.70"	H 50 cm / 19.70"
W 9 kg / 19.80 lb	W 12 kg / 26.40 lb	W 16 kg / 35.20 lb
WW 4x E27x60 W max (not included) USA 4x E26x60 W max (not included)	WW 5x E27x60 W max (not included) USA 5x E26x60 W max (not included)	WW 6x E27x60 W max (not included) USA 6x E26x60 W max (not included)



TECHNICAL INFO

FINITURE / FINISHING

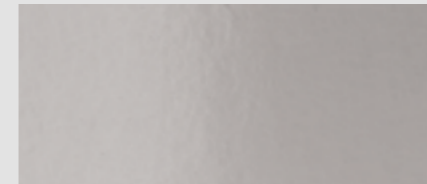
Bagno galvanico / Galvanic Bath



G07 Nickel spazzolato
Brushed nickel



G06 Cromo opaco
Matt chrome



G04 Cromo lucido
Shiny chrome



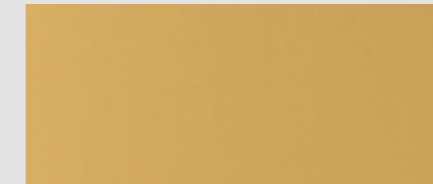
G21 Cromo anticato
Antiqued chrome



G14 Ottone brunito
Burnished brass



G01 Brunito
Burnished



G05 Oro opaco
Matt gold



G03 Oro lucido
Shiny gold



G12 Oro spazzolato
Brushed gold



G20 Oro anticato
Antiqued gold



G18 Ottone spazzolato
Brushed brass

Verniciati / Painted



V71 Nickel opaco verniciato
Painted matt nickel



V93 Oro verniciato
Painted gold

Verificare la disponibilità di ciascuna finitura per specifici articoli / Availability of each finish to be confirmed for specific items.

Indice/Index

COD.	ART.	Ø/L-SP	H	PAG.
VE 760	S8 RD - PL8 RD	60 cm	18 cm	44-40
	S10 RD - PL10 RD	90 cm	18 cm	44-40
	S16 RD - PL16 RD	120 cm	18 cm	45-41
	S12 SQ - PL12 SQ	60 - 60 cm	18 cm	52-48
	S16 SQ - PL16 SQ	90 - 90 cm	18 cm	53-48
	S24 SQ - PL24 SQ	120 - 120 cm	18 cm	52-48
	S16 RC - PL16 RC	100 - 60 cm	18 cm	47-46
	S20 RC - PL20 RC	150 - 60 cm	18 cm	47-46
	S26 RC - PL26 RC	200 - 80 cm	18 cm	47-46
	S5 LN - PL5 LN	80 - 17 cm	18 cm	42-43
	S6 LN - PL6 LN	100 - 17 cm	18 cm	42-43
	S7 LN - PL7 LN	120 - 17 cm	18 cm	42-43
	S12 OV - PL12 OV	103 - 63 cm	18 cm	51-50
	S16 OV - PL16 OV	150 - 75 cm	18 cm	51-50
	S22 OV - PL22 OV	200 - 85 cm	18 cm	51-50
	A2 RC	30 - 14 cm	18 cm	55
	A2 RD	32 - 17 cm	18 cm	54
VE 764	A9 G	24 - 12 cm	104 cm	57
	A4 P	22 - 8 cm	70 cm	57
	S16	86 cm	88 cm	59
VE 770	A2	17 - 12 cm	40 cm	39
	S28	120 - 40 cm	40 cm	38
	S34	160 - 40 cm	40 cm	37
VE 802	12+6	110 cm	150 cm	5-6
	A3	60 - 32 cm	90 cm	7
VE 803	13+6	100 cm	130 cm	9
VE 804	6+3+3	60 cm	100 cm	10
	8+4+4	90 cm	120 cm	11
	20	120 cm	150 cm	13
	A3	45 - 25 cm	60 cm	11
VE 805	8+4+1	100 cm	100 cm	14
	12+6+1	140 cm	150 cm	15
VE 808	PL3 40	40 cm	25 cm	70
	PL3 50	50 cm	30 cm	70
	PL 8+4	75 cm	35 cm	70
	PL16	100 cm	45 cm	70
VE 809	A3	40 - 14 cm	12 cm	71
	PL4	50 - 50 cm	25 cm	68
	PL8	70 - 70 cm	30 cm	68
	PL12	105 - 105 cm	35 cm	68
	PL48	160 - 160 cm	40 cm	69
VE 810	S15+1	60 cm	100 cm	73
	S24+1	100 cm	220 cm	72
	S28+1	120 cm	250 cm	72
VE 811	PL 3 RD - S3 RD	40 cm	30 cm	114-112
	PL8 RD - S8 RD	60 cm	40 cm	114-112
	PL10 RD - S10 RD	80 cm	50 cm	114-112
	PL12 RD - S12 RD	100 cm	60 cm	115-113
	PL4 OV - S4 OV	80 - 40 cm	30 cm	117-116
	PL5 OV - S5 OV	100 - 40 cm	40 cm	117-116
	PL6 OV - S6 OV	120 - 60 cm	50 cm	117-116
VE 814	12 50	50 - 50 cm	170 cm	81
	16 75	75 - 75 cm	200 cm	80
VE 815	10+1	80 cm	90 cm	111
	12+1	100 cm	90 cm	110
	A2	30 - 14 cm	20 cm	111
	A2+2	48 - 14 cm	24 cm	111
VE 818	12	60 cm	100 cm	16
	16	78 cm	140 cm	16
	18	100 cm	165 cm	17
	A3	32 - 19 cm	70 cm	19
	PL 12	60 cm	45 cm	19
	PL16	78 cm	60 cm	19
	PL18	100 cm	70 cm	18
VE 820	PL10+2	80 - 40 cm	50 cm	76
	PL12+2	100 - 55 cm	50 cm	76
	PL20	150 - 47 cm	50 cm	77
	PL26	200 - 55 cm	50 cm	76

COD.	ART.	Ø/L-SP	H	PAG.
VE 821	PL24	80 - 80 cm	27 cm	74
	PL28	110 - 60 cm	27 cm	75
	PL32	122 - 60 cm	27 cm	75
	PL44	166 - 80 cm	27 cm	75
VE 823	20	90 cm	160 cm	23
	A3	30 - 15 cm	55 cm	21
	PL12	90 cm	60 cm	20
VE 825	A8 G	30 - 13 cm	100 cm	84
	A8 M	25 - 12 cm	70 cm	85
	S6	30 cm	230 cm	83
VE 827	20	116 cm	160 cm	27
	A4	45 - 20 cm	70 cm	25
	PL8	70 cm	55 cm	25
	PL10	90 cm	70 cm	24
VE 829	22	115 cm	190 cm	31
	66	180 cm	300 cm	30
	A3	35 - 18 cm	62 cm	28
	PL6	60 cm	40 cm	28
	PL8	80 cm	50 cm	28
	PL12	115 cm	70 cm	29
VE 830	PL8	70 cm	40 cm	32
	PL12	100 cm	50 cm	32
VE 831	PL6	45 cm	40 cm	33
	PL10	80 cm	50 cm	33
	PL12	100 cm	55 cm	33
VE 836	PL3	30 cm	25 cm	66
	PL6	40 cm	35 cm	67
VE 840	A2	30 - 13 cm	40 cm	88
	PL4	29 cm	80 cm	88
	PL6	37 cm	90 cm	89
	PL8	40 cm	200 cm	87
	PL12	60 cm	200 cm	86
VE 841	G	77 cm	200 cm	91
	M	44 cm	170 cm	92
	P	27 cm	100 cm	93
VE 843	13	60 cm	240 cm	95
VE 845	16+1	120 cm	110 cm	97
VE 846	PL5	40 cm	20 cm	65
	PL6	70 cm	35 cm	64
	PL8	80 cm	40 cm	64
VE 849	26	120 cm	270 cm	35
	PL10	70 cm	55 cm	34
	PL12	95 cm	70 cm	34
VE 864	10 60	60 cm	110 cm	99
	14 90	90 cm	150 cm	99
	20 120	120 cm	200 cm	99
	24 150	150 cm	250 cm	98
	A4	30 - 21 cm	57 cm	99
VE 892	A2 - A2 TRASP	15 - 12 cm	70 cm	103-102
	S6 - S6 TRASP	30 cm	180 cm	101-100
VE 893	S9 - S9 TRASP	70 cm	80 cm	109-108
VE 895	S6 - S6 TRASP	126 - 15 cm	40 cm	104-106
	S8 - S8 TRASP	160 - 15 cm	40 cm	104-106
	S10 - S10 TRASP	200 - 15 cm	40 cm	104-106
VE 897	PL4	40 cm	20 cm	79
	PL6	60 cm	20 cm	79
	PL8	90 cm	20 cm	78
	PL16	120 cm	20 cm	79
VE 1150	A2	25 - 13 cm	40 cm	61
	S12	90 cm	40 cm	60
VE 1152	S4 LN	75 - 22,5 cm	38 cm	62
	S5 LN	105 - 22,5 cm	38 cm	62
	S6 LN	130 - 22,5 cm	38 cm	62
	S16 RC	105 - 75 cm	38 cm	63
	S18 RC	130 - 75 cm	38 cm	63
	S24 RC	165 - 90 cm	38 cm	63

CE

Attesta la conformità del prodotto alle disposizioni delle Direttive comunitarie.

It certifies the conformity of the products to the European Community provisions.

Il atteste la conformité du produit aux dispositions des directives communitaires.

Konformität des Produktes mit den Richtlinien der europäischen Gemeinschaft.

НАСТОЯЩИМ ПОДТВЕРЖДАЕТСЯ СООТВЕТСТВИЕ ПРОДУКЦИИ ПОЛОЖЕНИЯМ ДИРЕКТИВ ЕС.

Certifica la conformidad del producto según las disposiciones de las directivas comunitarias.

CE标记是指产品的制造商证明该产品符合适用的EC指令的所有基本要求。

يُشهد بمطابقة المنتج لأحكام توجيهات المجتمع الأوروبي.



Il logo "ETL" si riferisce agli articoli che possono essere modificati con componenti certificati ETL. L'elenco degli articoli ETL si riferisce a prodotti testati e valutati in base agli standard di sicurezza del mercato statunitense. Per il mercato USA fare riferimento al listino dedicato.

"ETL" logos refers to articles which can be modified with ETL-compliance components. The "ETL" listing articles stands for tested and evaluated product to recognised US safety standards. For the US market, refer to the relevant price list.

"ETL" logo se réfère aux articles qui peuvent être modifiés par des composants certifiés ETL. la liste des articles ETL se réfère à des produits testés et évalués selon les normes de sécurité du marché américain. Pour le marché américain se référer à la liste des prix.

Das "ETL"-Logo bezieht sich auf Artikel, die mit ETL-zertifizierten Komponenten modifiziert werden können. Die Liste der ETL-Artikel bezieht sich auf Produkte, die nach den Sicherheitsstandards des US-Marktes getestet und bewertet wurden. Für den US-Markt beachten Sie bitte die entsprechende Preisliste.

ЛОГОТИП «ETL» ОТНОСИТСЯ К ЭЛЕМЕНТАМ, КОТОРЫЕ МОГУТ БЫТЬ МОДИФИЦИРОВАНЫ С ПОМОЩЬЮ СЕРТИФИЦИРОВАННЫХ ETL КОМПОНЕНТОВ. СПИСОК ЭЛЕМЕНТОВ ETL ОТНОСИТСЯ К ПРОДУКЦИИ, ПРОТЕСТИРОВАННОЙ И ОЦЕНЕННОЙ В СООТВЕТСТВИИ С ПРИЗНАННЫМИ СТАНДАРТАМИ БЕЗОПАСНОСТИ США. ДЛЯ ПОТРЕБИТЕЛЕЙ НАХОДЯЩИХСЯ В США СМ. СООТВЕТСТВУЮЩИЙ ПРАЙС-ЛИСТ.

El logo "ETL" indica los artículos, que pueden modificarse con componentes certificados ETL. La lista de los artículos ETL se refiere a los productos sometidos a prueba y evaluados en función de los estándares de seguridad del mercado estadounidense. Consultar la lista de precios específica para el mercado de los Estados Unidos.

"ETL" 徽标是指可以使用ETL认证的组件进行修改的项目。 ETL项目列表是指根据美国市场的安全标准进行测试和评估的产品。 对于美国市场, 请参考美国市场价格表。

يشير شعار «ETL» إلى المنتجات التي يمكن تعديلها باستخدام مكونات مُعتمدة من ETL. تشير قائمة منتجات ETL إلى المنتجات التي تم اختبارها وتقييمها وفقًا لمعايير السلامة في السوق الأمريكي. بالنسبة لسوق الولايات المتحدة الأمريكية، يُرجى الرجوع إلى قائمة الأسعار المُخصصة.

Im

Flusso luminoso nominale. L'indicazione si riferisce al valore in assenza di rifrazione, come dichiarato dal produttore del componente.

Nominal luminous flux. It refers to the value without any refraction, as declared by the component manufacturer.

L'unité SI de flux lumineux. L'indication correspond à la valeur en l'absence de réfraction, comme indiqué par le fabricant du composant.

Die Maßeinheit für den Lichtstrom. Die Angabe bezieht sich auf den Wert in der Abwesenheit von Brechung, wie vom Hersteller der Komponente angegeben.

НОМИНАЛЬНЫЙ СВЕТОВОЙ ПОТОК. УКАЗАНИЕ ОТНОСИТСЯ К ЗНАЧЕНИЮ В ОТСУТСТВИЕ РЕФРАКЦИИ, КАК ЗАЯВЛЕНО ПРОИЗВОДИТЕЛЕМ КОМПОНЕНТОВ.

Flujo luminoso nominal. La indicación se refiere al valor sin refracción, como declarado por el fabricante del componente.

标称光通量。指示是指组件制造商声明的没有折射的值。

التدفق الضوئي الاسمي. يشير المؤشر إلى القيمة في حالة عدم وجود انكسار للضوء، كما هو مُعلن من قبل الشركة المصنعة للعنصر.

MASIERO

Masiero si riserva il diritto di apportare ai propri articoli, senza nessun preavviso, qualsiasi modifica ritenesse opportuna.

Masiero reserves the right to introduce any changes to its own products, without notice in advance.

Masiero se réserve le droit d'apporter une quelconque modification à les modèles sans préavis.

Masiero behält sich das Recht vor Änderungen vorzunehmen, ohne sofortige Benachrichtigung.

КОМПАНИЯ MASIERO ОСТАВЛЯЕТ ЗА СОБОЙ ПРАВО БЕЗ ПРЕДВАРИТЕЛЬНОГО УВЕДОМЛЕНИЯ, ЕСЛИ ЭТО БУДЕТ СОЧТЕНО ЦЕЛЕСООБРАЗНЫМ, ВНОСИТЬ В СОБСТВЕННЫЕ МОДЕЛИ ЛЮБЫЕ ИЗМЕНЕНИЯ.

Masiero se reserva el derecho de aportar modificaciones consideradas oportunas a sus artículos sin preaviso.

Masiero 保留对其认为适当的任何更改的权利, 恕不另行通知。

تحتفظ شركة مازيرو "Masiero" بالحق في إجراء أي تعديلات تراها مناسبة على منتجاتها، دون إشعار مسبق.

Masiero srl

via Peschiere, 53
31032 Casale sul Sile
Treviso, Italy
T +39 0422 7861
F +39 0422 786250

info@masierogroup.com
masierogroup.com

Design by Masiero
Photo, Studio Pointer
Print Italy, April 2021
by Grafica Antiga



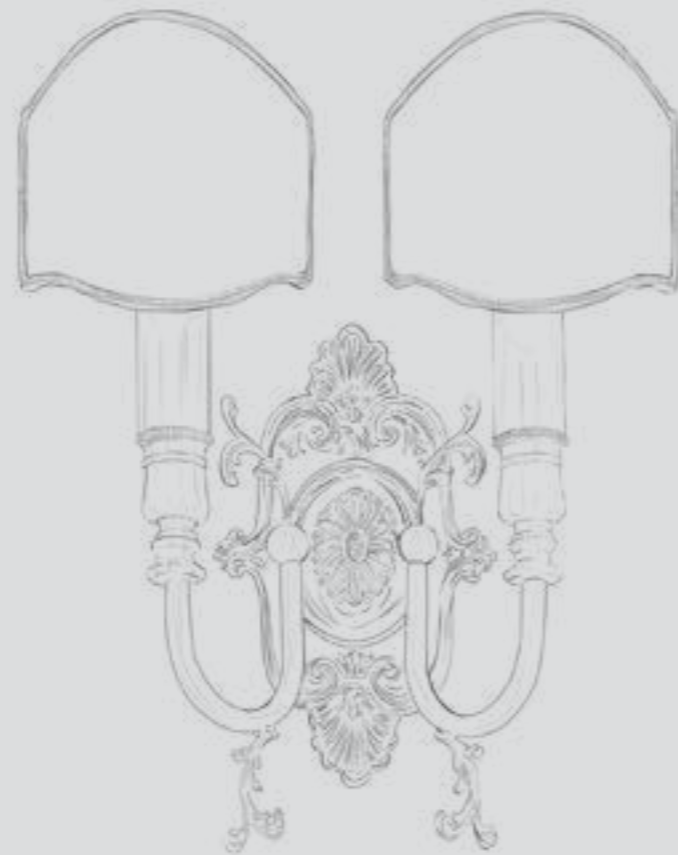
BRASS&SPOTS
ATELIER

MASIERO



BRASS&SPOTS
ATELIER

MASIERO



BRASS&SPOTS

La maestria artigianale modella i metalli più nobili per dar vita ad una collezione di punti luce discreti e raffinati. Lampade da parete che come piccoli gioielli luminosi contribuiscono a creare un'atmosfera magica nella stanza.

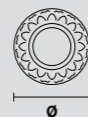
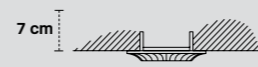
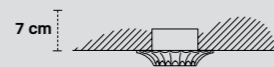
Lampade da tavolo preziose e ricercate che emanano una luce soffusa calda e confortevole rendendo ogni stanza un rifugio accogliente che trasmette pace e tranquillità.

The skill of craftsmen shapes the noblest of metals to create a collection of discreet and refined lighting elements.

Wall lamps like tiny luminous jewels help give the room a magical atmosphere. Elegant and refined table lamps give off a warm and comfortable soft light, making every room a cosy refuge that conveys peace and tranquillity.



VE 852 **CE** **VE 856** **CE**

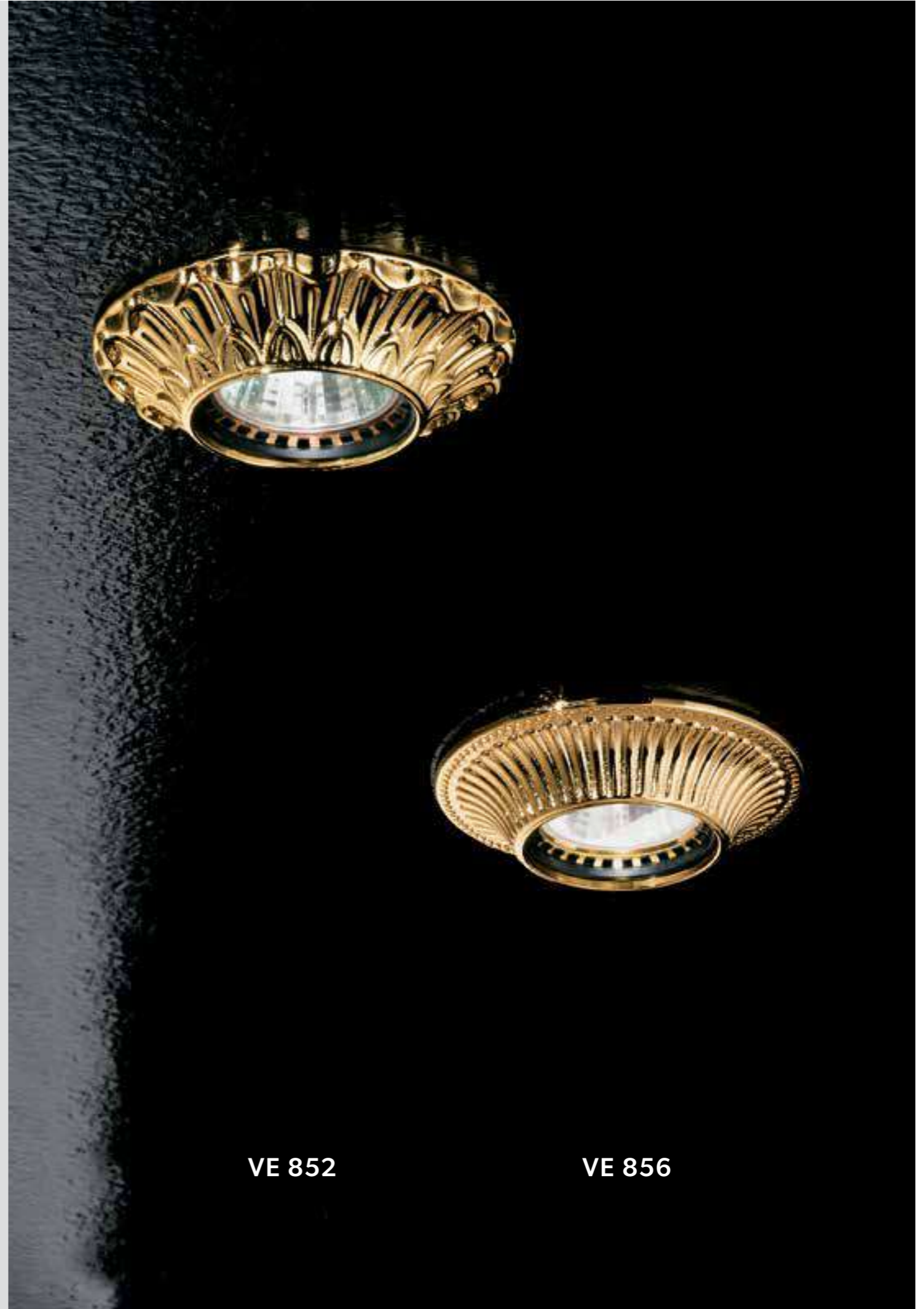


∅ 10 cm / 3.94"
W 0,5 kg / 1.10 lb

∅ 10 cm / 3.94"
W 0,5 kg / 1.10 lb

WW 1xGU10x50 W max (not included)
USA 1xGU10x50 W max (not included)

WW 1xGU10x50 W max (not included)
USA 1xGU10x50 W max (not included)



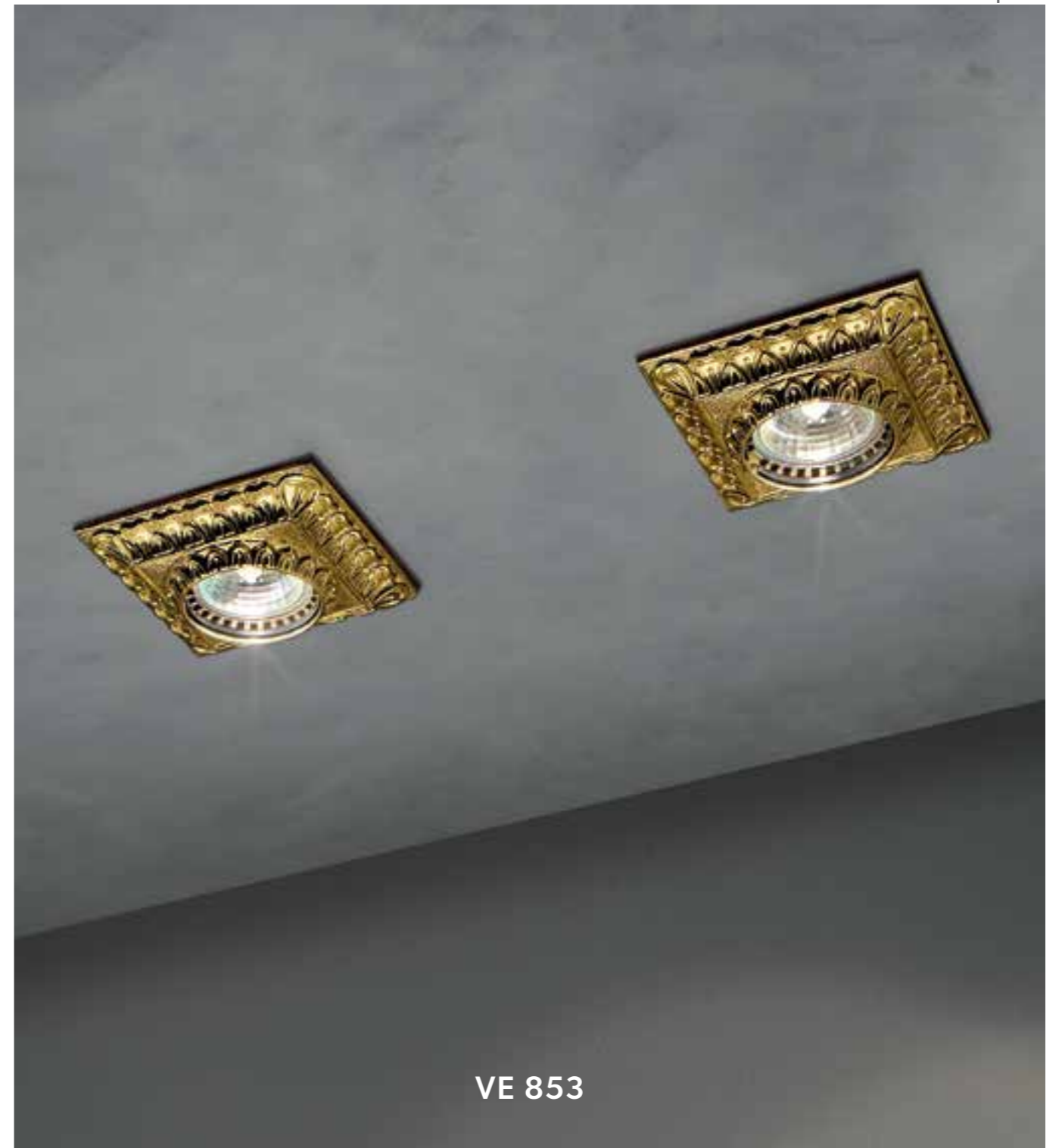
VE 852

VE 856



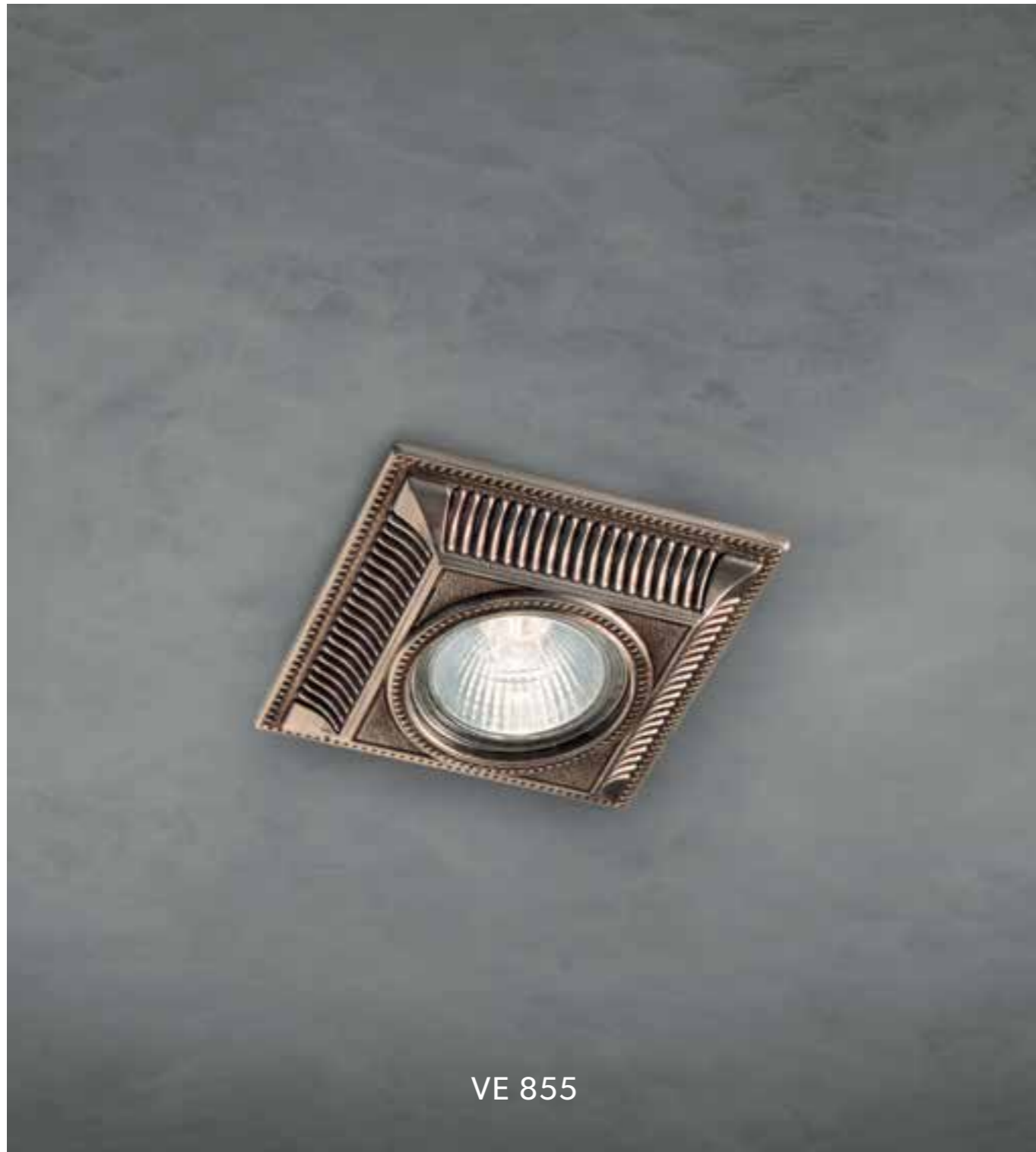
VE 857

VE 854



VE 853

VE 857	CE	VE 854	CE	VE 853	CE
<p>Ø 12 cm / 4.72"</p> <p>W 0,5 kg / 1.10 lb</p>		<p>Ø 12 cm / 4.72"</p> <p>W 0,5 kg / 1.10 lb</p>		<p>L 10X10 cm / 3.94"X3.94"</p> <p>W 0,5 kg / 1.10 lb</p>	
<p>WW 1xGU10x50 W max (not included)</p> <p>USA 1xGU10x50 W max (not included)</p>		<p>WW 1xGU10x50 W max (not included)</p> <p>USA 1xGU10x50 W max (not included)</p>		<p>WW 1xGU10x50 W max (not included)</p> <p>USA 1xGU10x50 W max (not included)</p>	

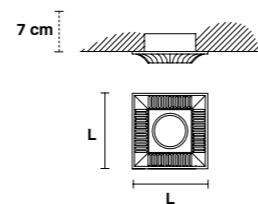


VE 855



VE 855

VE 855 



.....
L 10X10 cm /
 3.94"X3.94"
W 0,5 kg / 1.10 lb

WW 1xGU10x50 W max(not included)
USA 1xGU10x50 W max (not included)



VE 866	CE	VE 865	CE	VE 856/G	CE
Ø 8 cm / 3.15"		Ø 8 cm / 3.15"		Ø 16 cm / 6.30"	
W 0,5 kg / 1.10 lb		W 0,5 kg / 1.10 lb		W 0,6 kg / 1.32 lb	
WW 1xGU10x50 W max (not included)		WW 1xGU10x50 W max (not included)		WW 1xGU10x50 W max (not included)	
USA 1xGU10x50 W max (not included)		USA 1xGU10x50 W max (not included)		USA 1xGU10x50 W max (not included)	



VE 1103

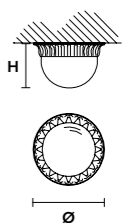
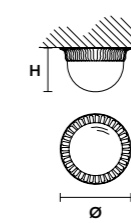
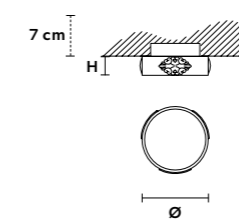
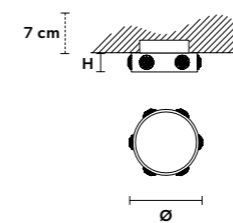
VE 1104



VE 1080/PL1

VE 1081/PL1

VE 1103 CE VE 1104 CE VE 1080/PL1 CE VE 1081/PL1 CE



Ø 10 cm / 3.94"
H 2.8 cm / 1.10"
W 0.4 kg / 0.88 lb

Ø 10 cm / 3.94"
H 3 cm / 1.18"
W 0.7 kg / 1.54 lb

Ø 16 cm / 6.30"
H 12 cm / 4.72"
W 2 kg / 4.40 lb

Ø 16 cm / 6.30"
H 12 cm / 4.72"
W 2 kg / 4.40 lb

WW 1xGU10x50 W max (not included)
USA 1xGU10x50 W max (not included)

WW 1xGU10x50 W max (not included)
USA 1xGU10x50 W max (not included)

WW 1xE14x40 W max (not included)
USA 1xE12x40 W max (not included)

WW 1xE14x40 W max (not included)
USA 1xE12x40 W max (not included)

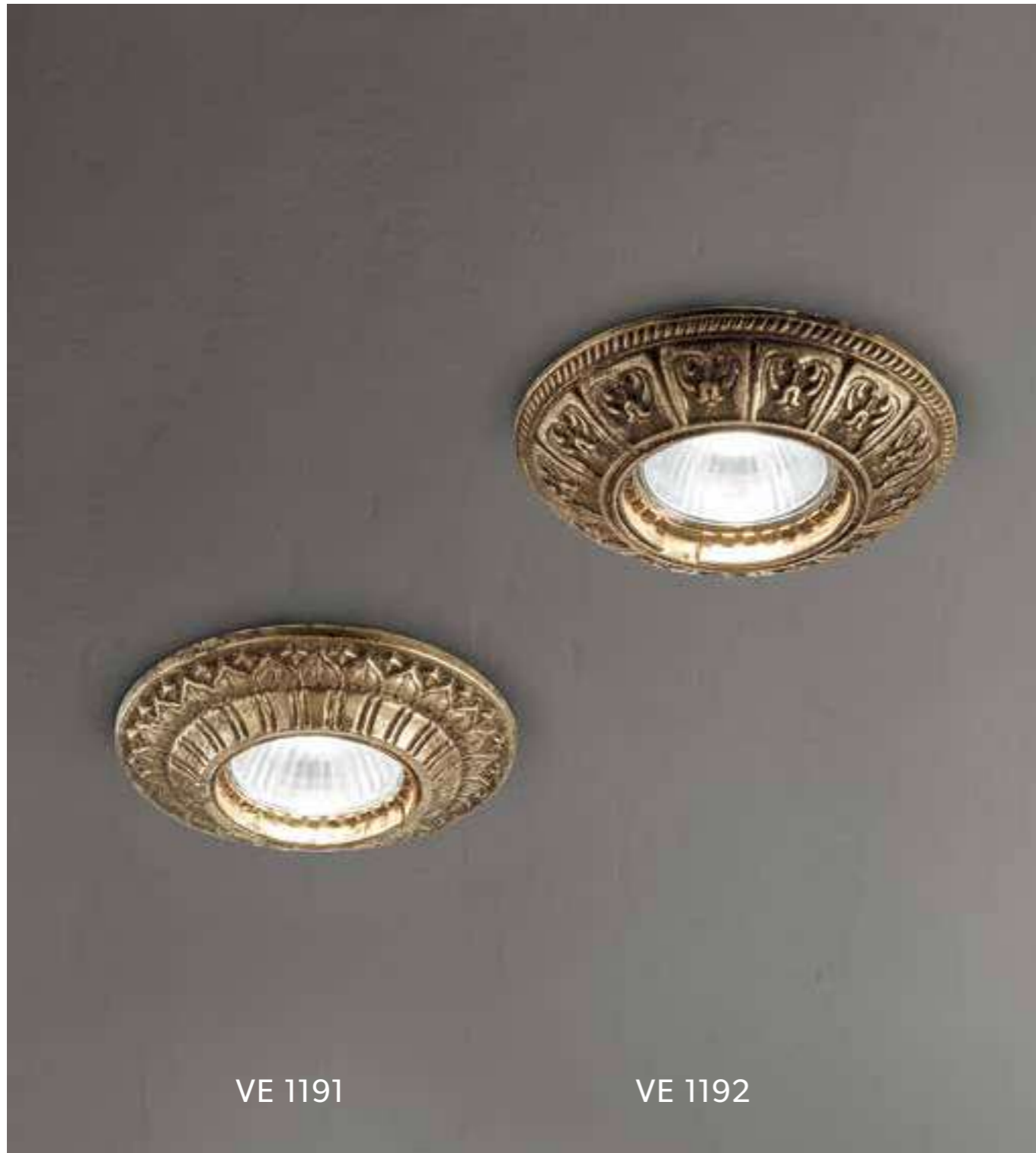


VE 1105



VE 1106

VE 1105	CE	VE 1106	CE
L 16 cm / 6.29" SP 9 cm / 3.54" H 5.5 cm / 2.17" W 0,2 kg / 0.44 lb		Ø 22 cm / 8.66" H 2.5 kg / 0.98 lb W 0,4 kg / 0.88 lb	
WW 1xGU10x50 W max (not included) USA 1xGU10x50 W max (not included)		WW 1xGU10x50 W max (not included) USA 1xGU10x50 W max (not included)	



VE 1191

VE 1192

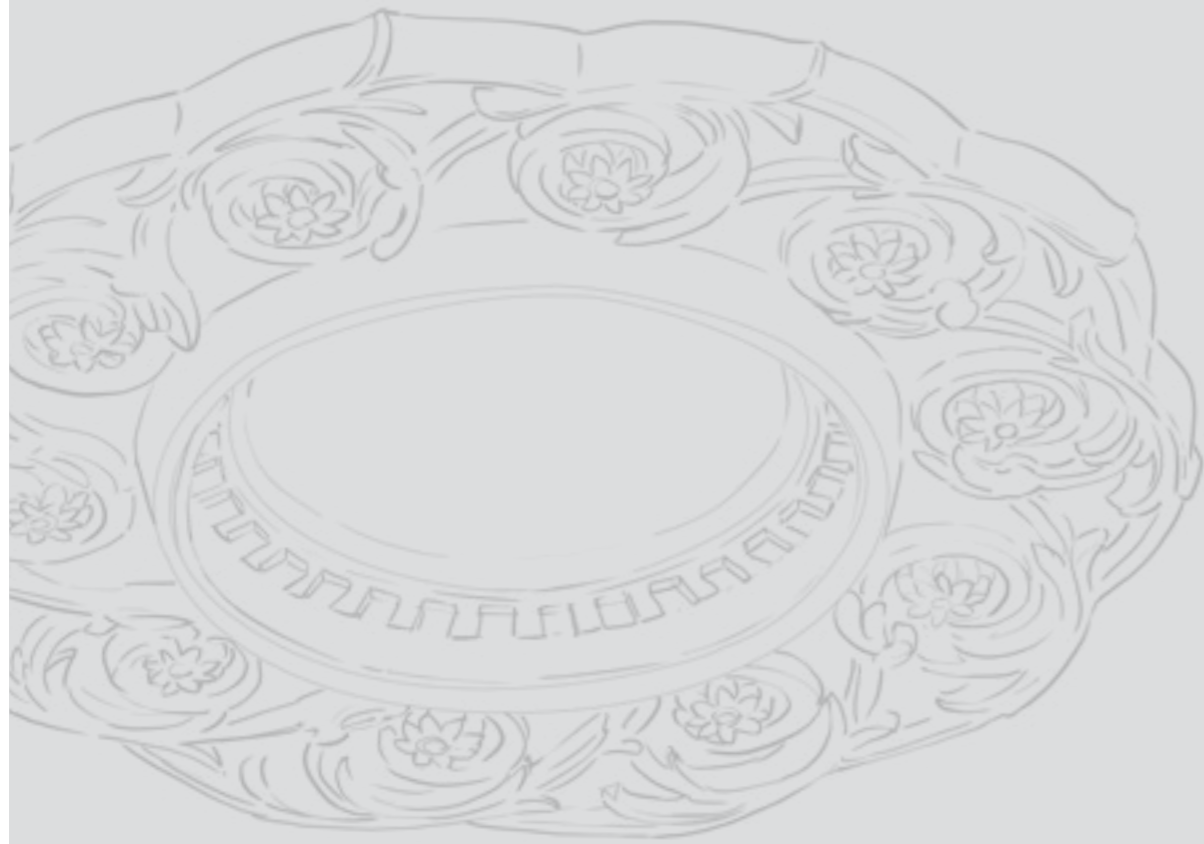


VE 859

VE 1190

VE 1191	CE	VE 1192	CE
<p>Ø 10 cm / 3.94"</p> <p>W 0,5 kg / 1.10 lb</p>		<p>Ø 10 cm / 3.94"</p> <p>W 0,5 kg / 1.10 lb</p>	
<p>WW 1xGU10x50 W max (not included)</p> <p>USA 1xGU10x50 W max (not included)</p>		<p>WW 1xGU10x50 W max (not included)</p> <p>USA 1xGU10x50 W max (not included)</p>	

VE 859	CE	VE 1190	CE
<p>L 10 x 10 cm /</p> <p>3.94" x 3.94</p> <p>W 0.5 kg / 1.10 lb</p>		<p>L 10 x 10 cm /</p> <p>3.94" x 3.94</p> <p>W 0.5 kg / 1.10 lb</p>	
<p>WW 1xGU10x50 W max (not included)</p> <p>USA 1xGU10x50 W max (not included)</p>		<p>WW 1xGU10x50 W max (not included)</p> <p>USA 1xGU10x50 W max (not included)</p>	



VE 1193 **CE** **VE 1194** **CE**



Ø 10 cm / 3.94"
W 0,5 kg / 1.10 lb

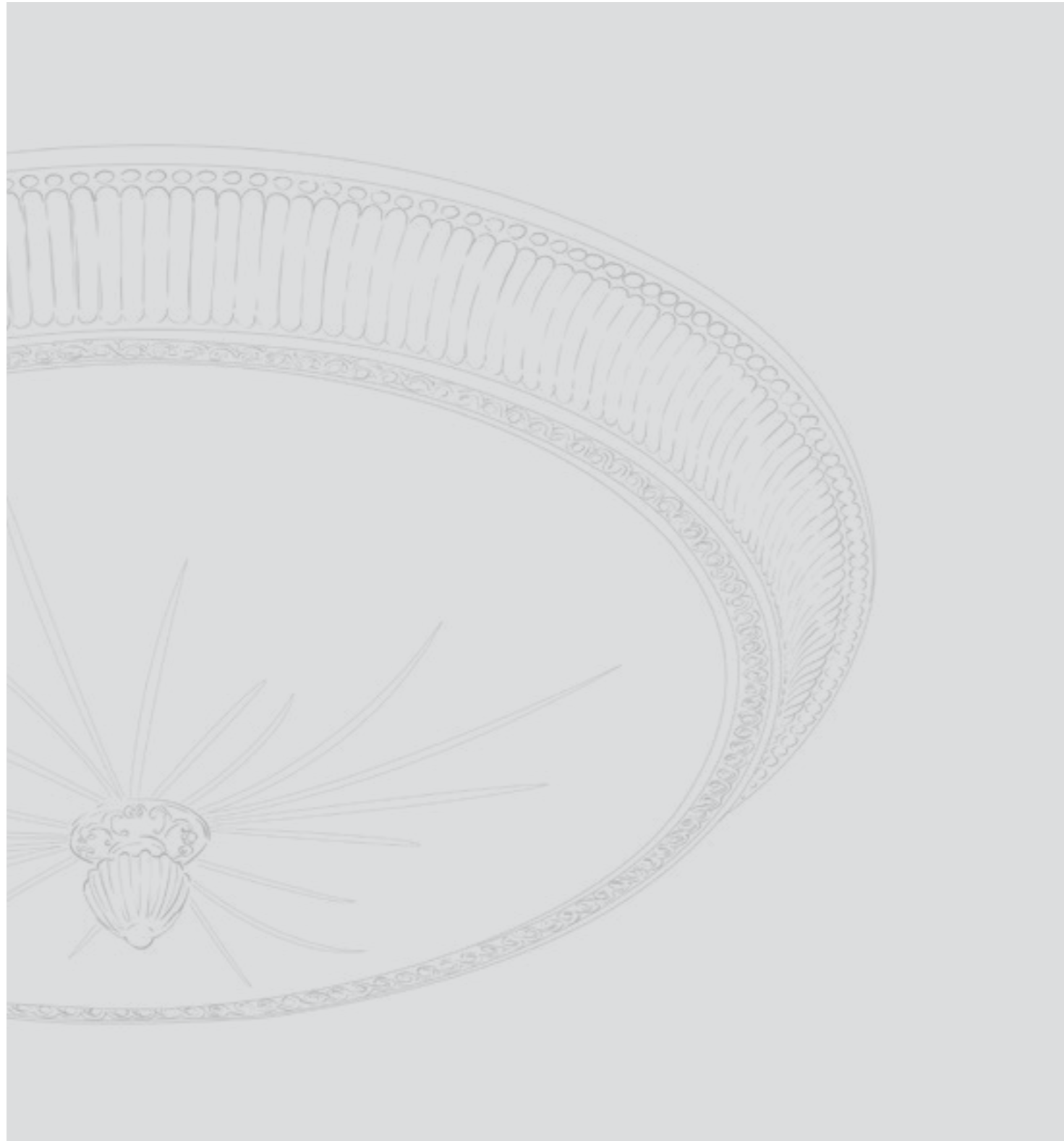
Ø 10 cm / 3.94"
W 0,5 kg / 1.10 lb

WW 1xGU10x50 W max (not included)
USA 1xGU10x50 W max (not included)

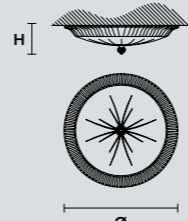
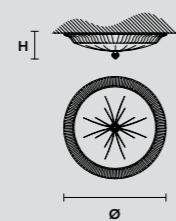
WW 1xGU10x50 W max (not included)
USA 1xGU10x50 W max (not included)

VE 1193

VE 1194



VE 1080/PL3 40 € **VE 1080/PL3 50** €



Ø 40 cm / 15.75"
H 15 cm / 5.91"
W 6 kg / 13.22 lb

Ø 50 cm / 19.71"
H 15 cm / 5.91"
W 8.5 kg / 18.73 lb

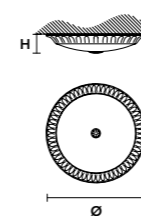
WW 3×E14×40 W max (not included)
USA 3×E12×40 W max (not included)

WW 3×E27×60 W max (not included)
USA 3×E26×60 W max (not included)

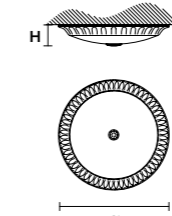
VE 1080/PL3 50



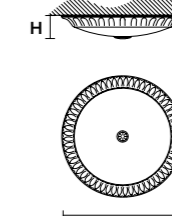
VE 1081/PL3 40 CE VE 1081/PL3 50 CE VE 1081/PL6 CE



Ø 40 cm / 15.75"
 H 12 cm / 4.72"
 W 6 kg / 13.22 lb
 WW 3×E14×40 W max (not included)
 USA 3×E12×40 W max (not included)



Ø 50 cm / 19.71"
 H 12 cm / 4.72"
 W 8.5 kg / 18.73 lb
 WW 3×E27×60 W max (not included)
 USA 3×E26×60 W max (not included)



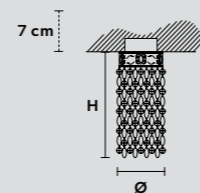
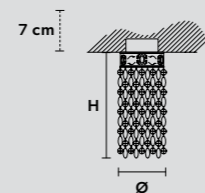
Ø 80 cm / 31.50"
 H 17 cm / 6.69"
 W 16 kg / 32.27 lb
 WW 6×E27×60 W max (not included)
 USA 6×E26×60 W max (not included)



VE 1107 MC



VE 1107 TR



Ø 9.5 cm / 3.74"
H 20 cm / 7.87"
W 0.6 kg / 1.32 lb

WW 1xGU10x50 W max (not included)
USA 1xGU10x50 W max (not included)

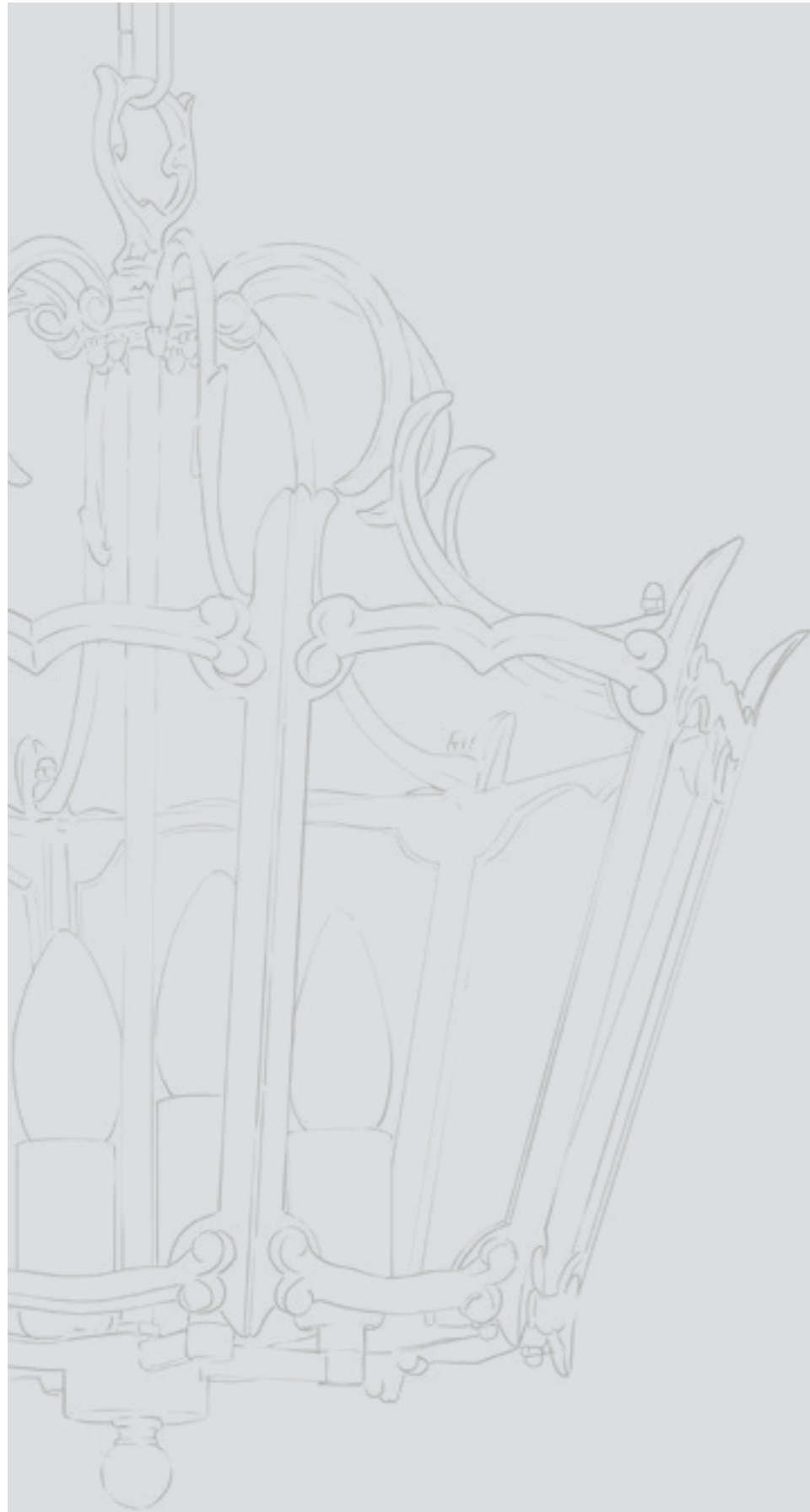
Ø 9.5 cm / 3.74"
H 20 cm / 7.87"
W 0.6 kg / 1.32 lb


WW 1xGU10x50 W max (not included)
USA 1xGU10x50 W max (not included)

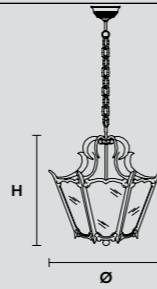


VE 1107 MC

VE 1107 TR



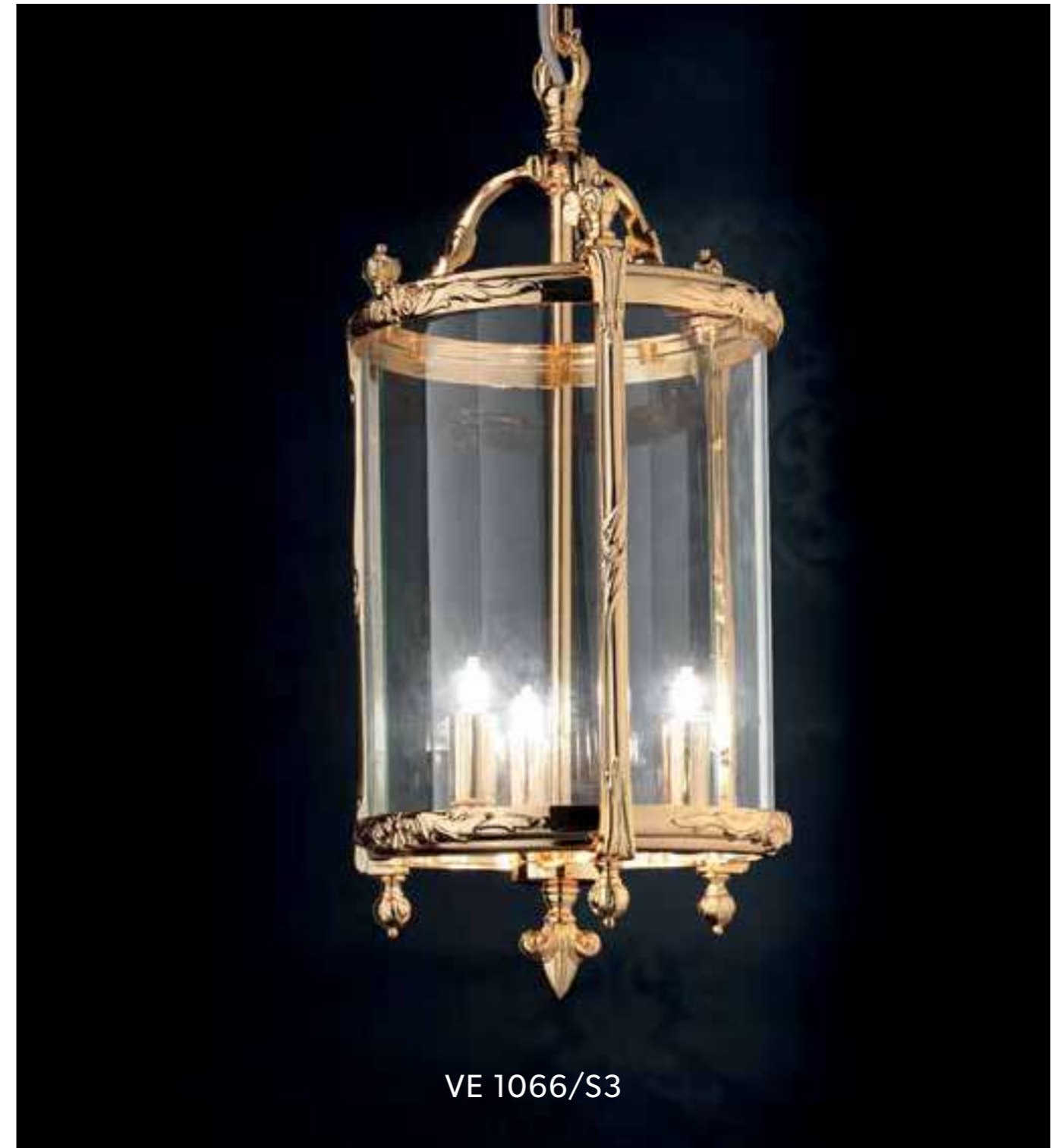
VE 1069/S4 



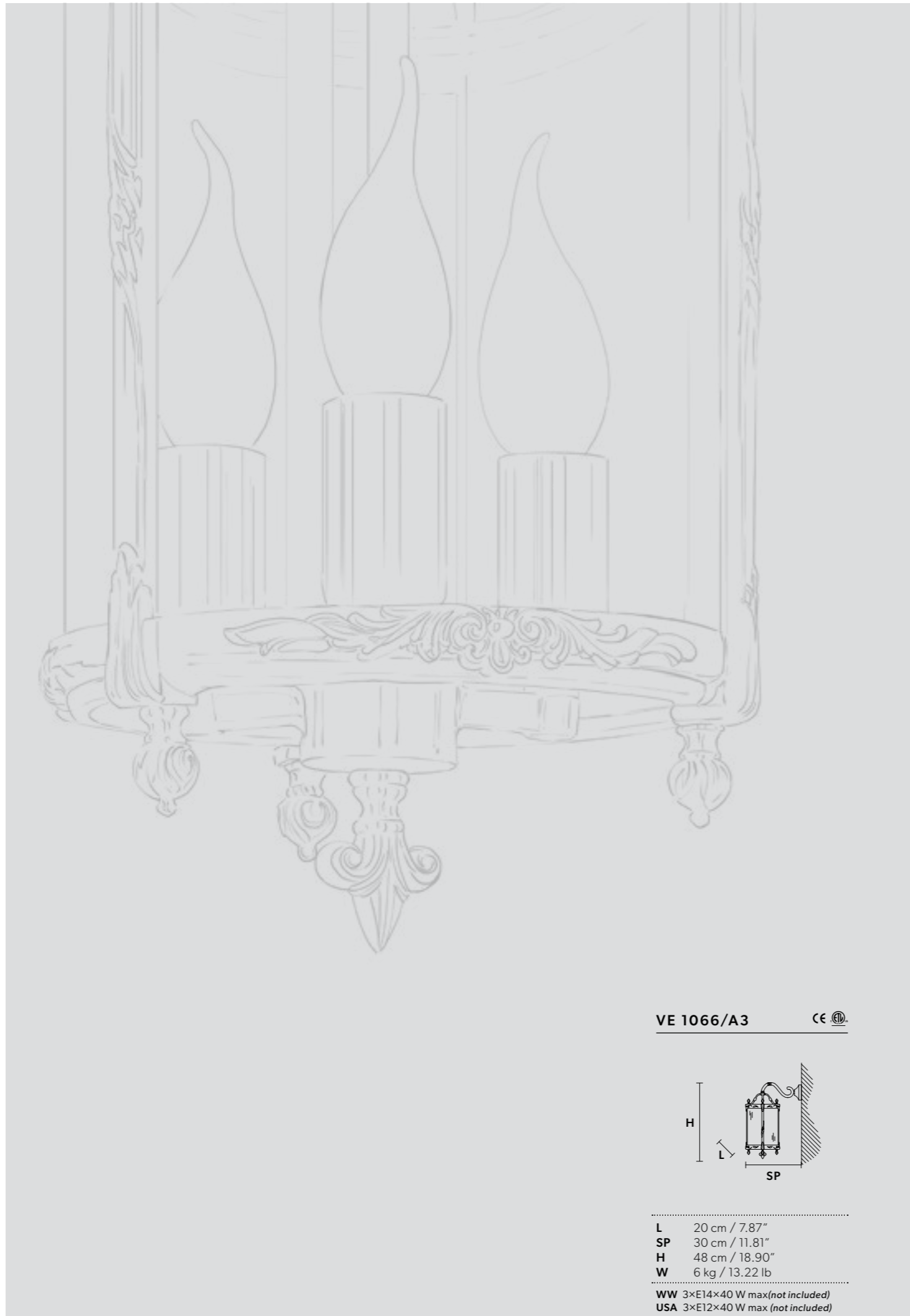
Ø 42 cm / 16.54"
H 44 cm / 17.32"
W 8 kg / 17.63 lb
.....
WW 4×E14×40 W max (not included)
USA 4×E12×40 W max (not included)

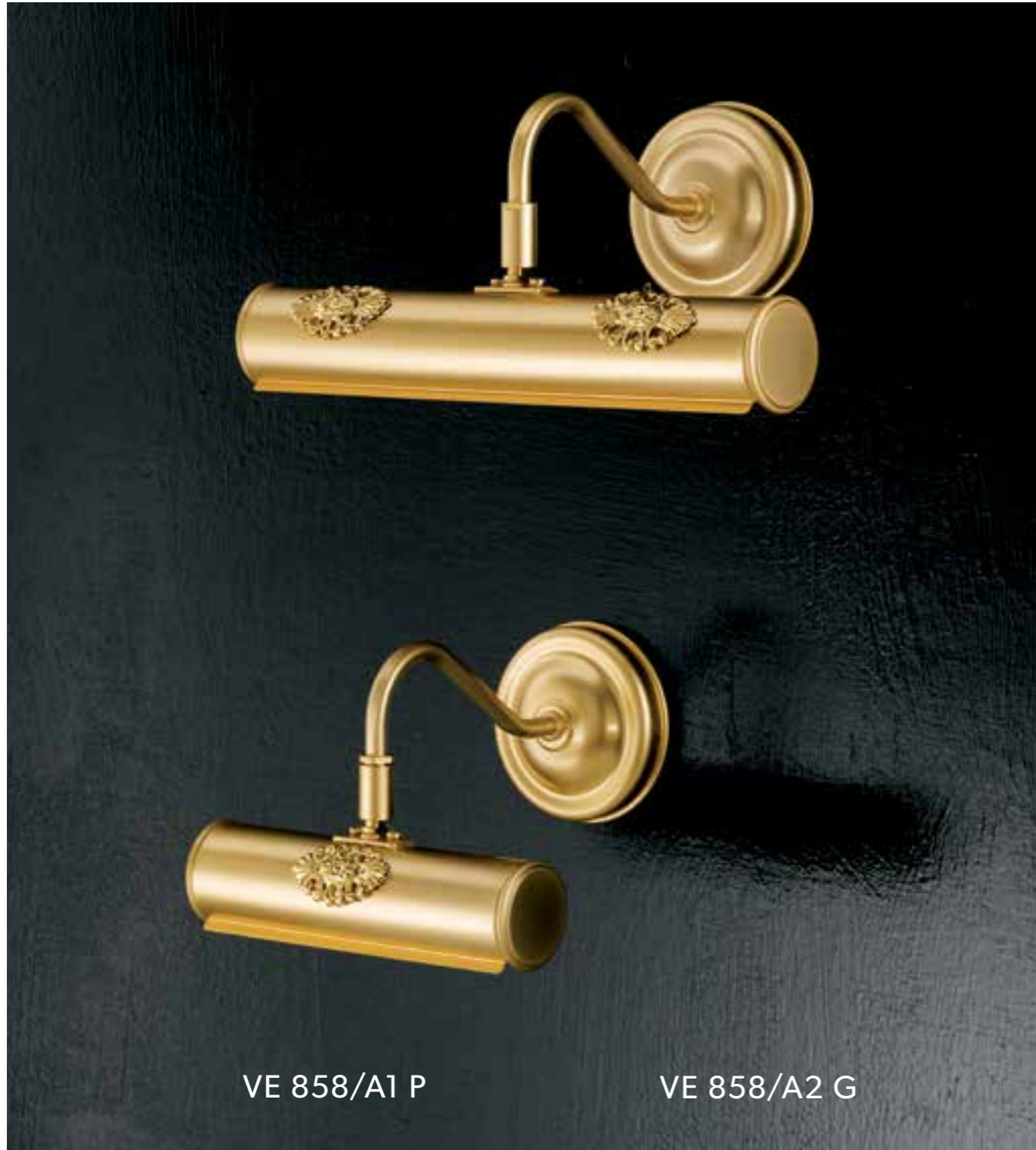


VE 1069/S4



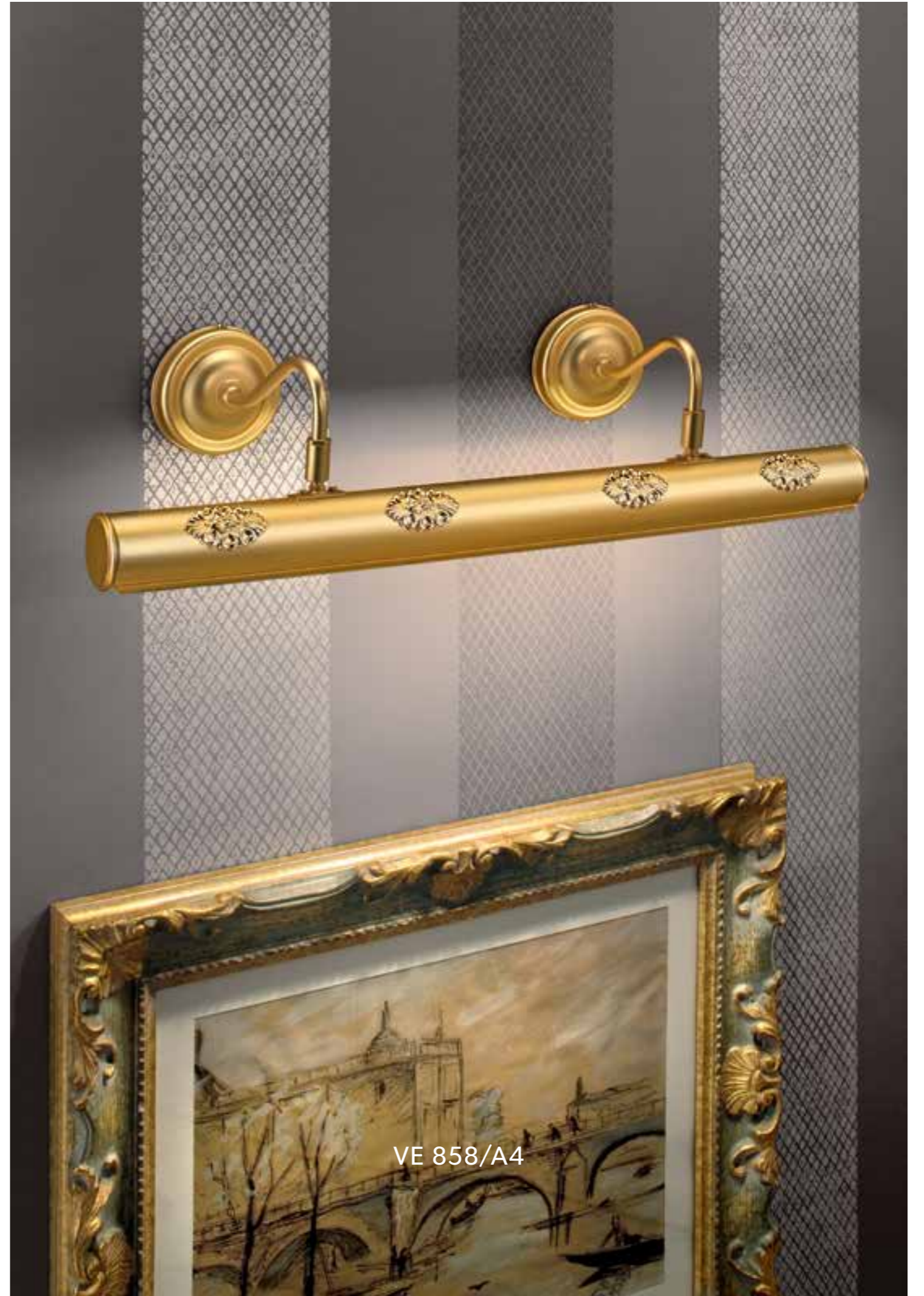
VE 1066/S3	CE	VE 1066/S4	CE	VE 1066/S6	CE
Ø 20 cm / 7.87"		Ø 44 cm / 17.32"		Ø 62 cm / 24.41"	
H 44 cm / 17.32"		H 85 cm / 33.46"		H 120 cm / 47.24"	
W 5 kg / 11.02 lb		W 8 kg / 17.63 lb		W 18 kg / 39.68 lb	
WW 3×E14×40 W max (not included)		WW 4×E14×40 W max (not included)		WW 6×E14×40 W max (not included)	
USA 3×E12×40 W max (not included)		USA 4×E12×40 W max (not included)		USA 6×E12×40 W max (not included)	





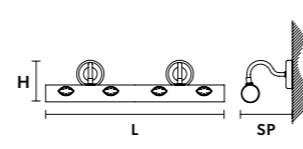
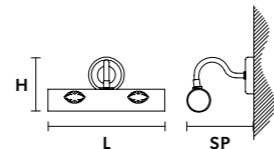
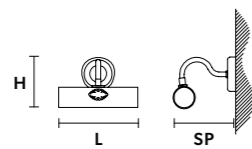
VE 858/A1 P

VE 858/A2 G



VE 858/A4

VE 858/A1 P VE 858/A2 G VE 858/A4



L 20 cm / 7.87"
SP 20 cm / 7.87"
H 15 cm / 5.91"
W 1.5 kg / 3.30 lb
WW 1x E14x40 W max (not included)
USA 1x E12x40 W max (not included)

L 30 cm / 11.81"
SP 20 cm / 7.87"
H 15 cm / 5.91"
W 1.5 kg / 3.30 lb
WW 2x E14x40 W max (not included)
USA 2x E12x40 W max (not included)

L 60 cm / 23.62"
SP 20 cm / 7.87"
H 15 cm / 5.91"
W 5 kg / 11.02 lb
WW 4x G9x40 W max (not included)
USA 4x G9x40 W max (not included)

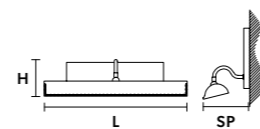
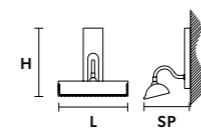


VE 868/P

VE 868/P



VE 868/G



L 12 cm / 4.72"
SP 15 cm / 5.91"
H 15 cm / 5.91"
W 3 kg / 6.61 lb

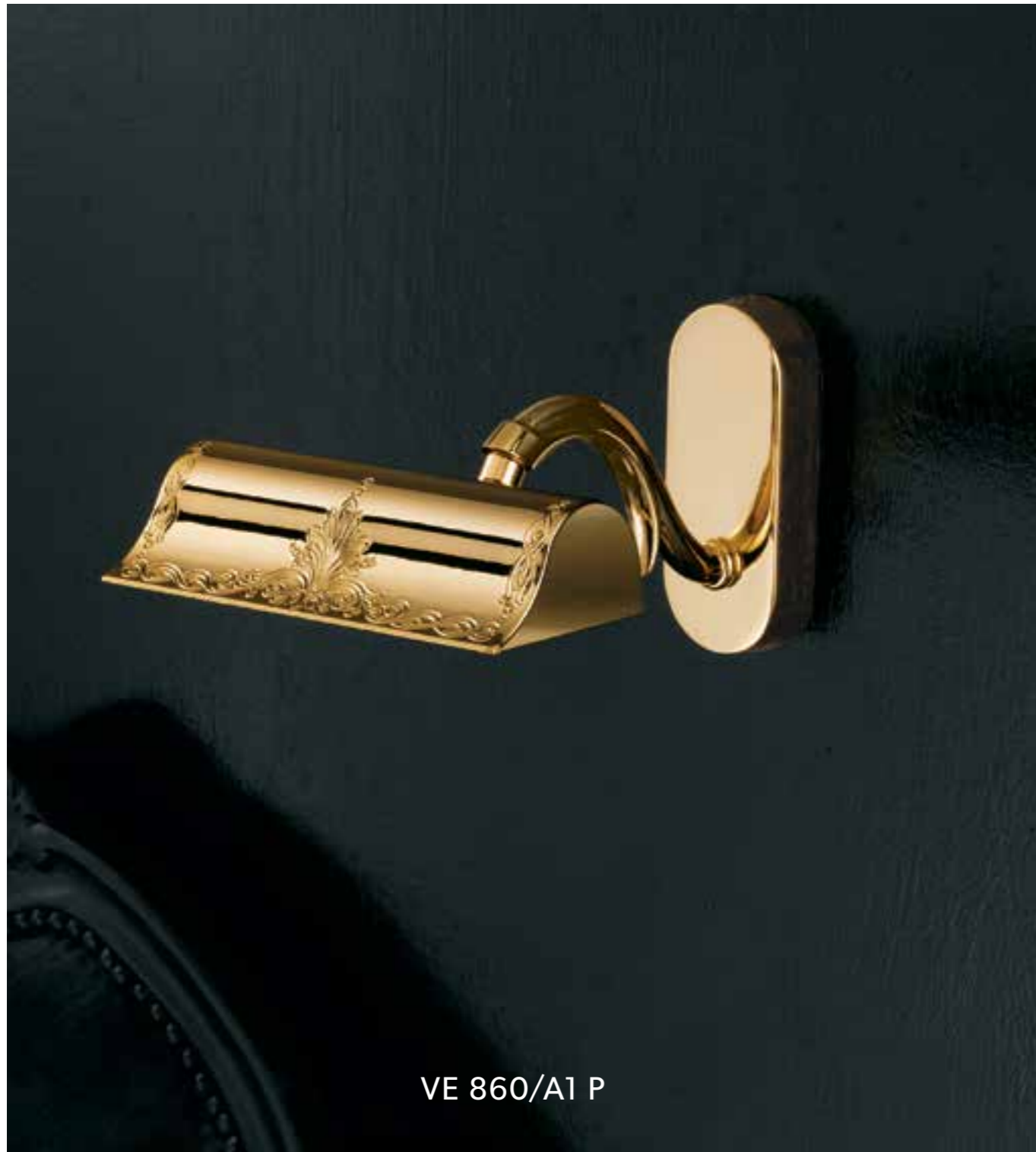
WW LED X 3 W 3000K
USA LED X 3 W 3000K

L 31 cm / 12.20"
SP 15 cm / 5.91"
H 10 cm / 3.94"
W 4.5 kg / 9.92 lb

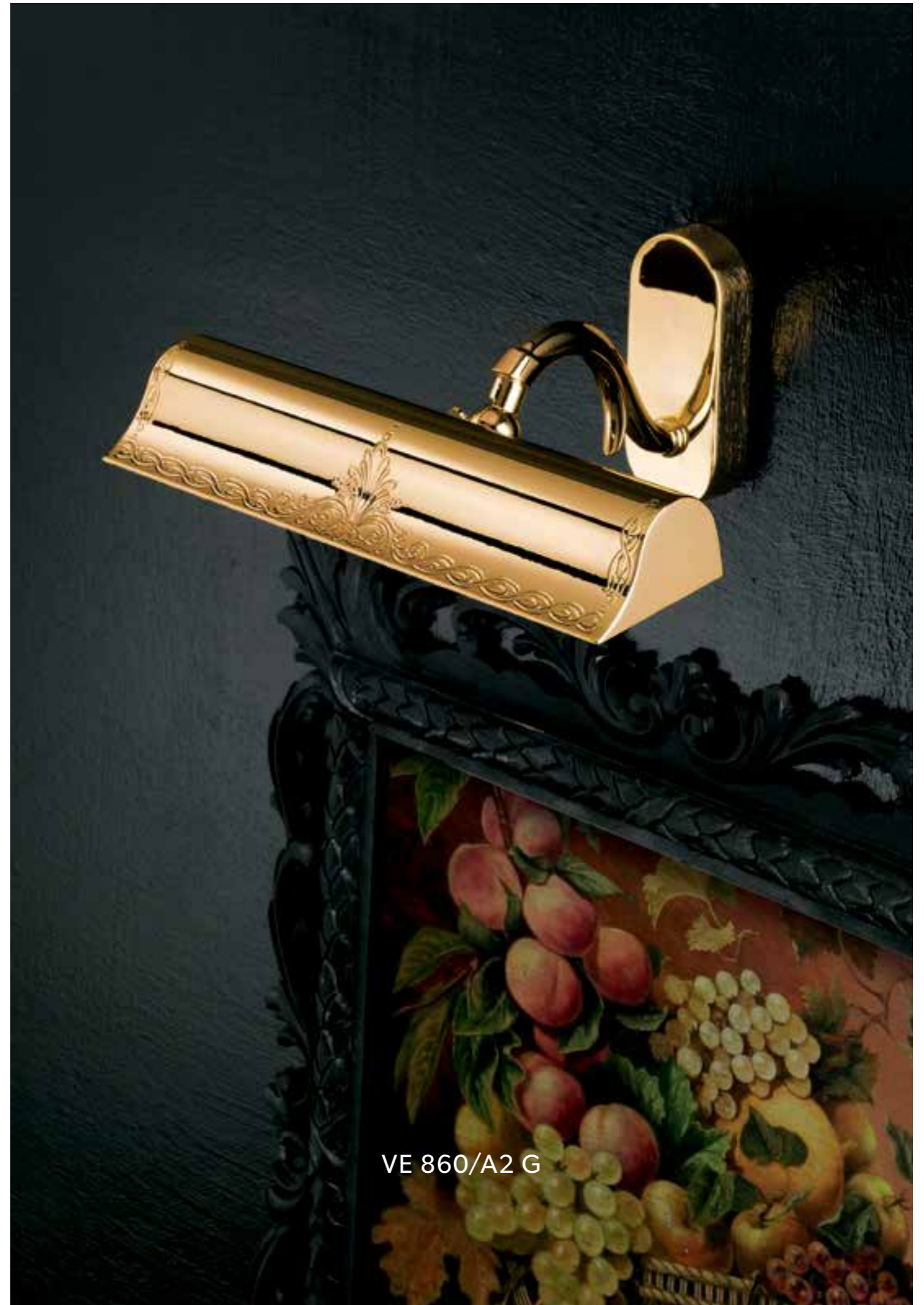
WW LED X 5 W 3000K
USA LED X 5 W 3000K



VE 868/G




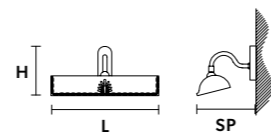
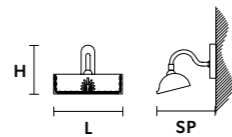
VE 860/A1 P



VE 860/A2 G

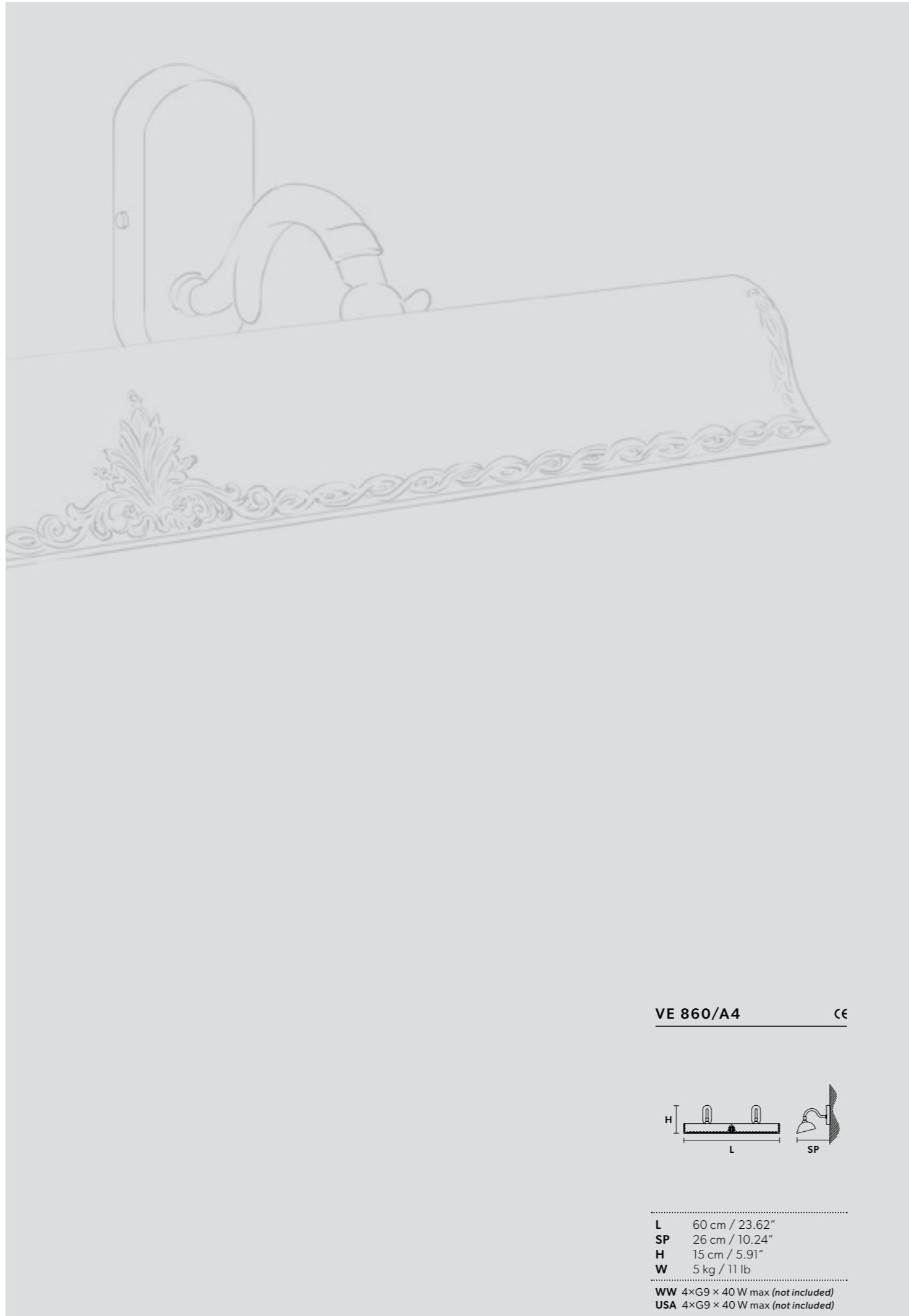
VE 860/A1 P 

VE 860/A2 G 




L	20 cm / 7.87"
SP	26 cm / 10.24"
H	15 cm / 5.91"
W	2 kg / 4.40 lb
WW 1x E14x40 W max (not included)	
USA 1x E12x40 W max (not included)	

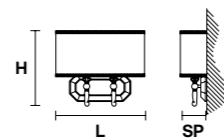
L	31 cm / 12.20"
SP	26 cm / 10.24"
H	15 cm / 5.91"
W	2.2 kg / 4.84 lb
WW 1x E14x40 W max (not included)	
USA 1x E12x40 W max (not included)	






VE 1065/A2

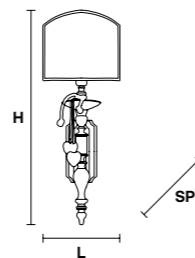
VE 1065/A2 



L 37 cm / 14.57"
 SP 11 cm / 4.33"
 H 28 cm / 11.02"
 W 5 kg / 11.02 lb

WW 2×E14×40 W max(not included)
 USA 2×E12×40 W max(not included)

VE 1002/A1 



L 20 cm / 7.87"
 SP 15 cm / 5.91"
 H 55 cm / 21.65"
 W 2.5 kg / 5.51 lb

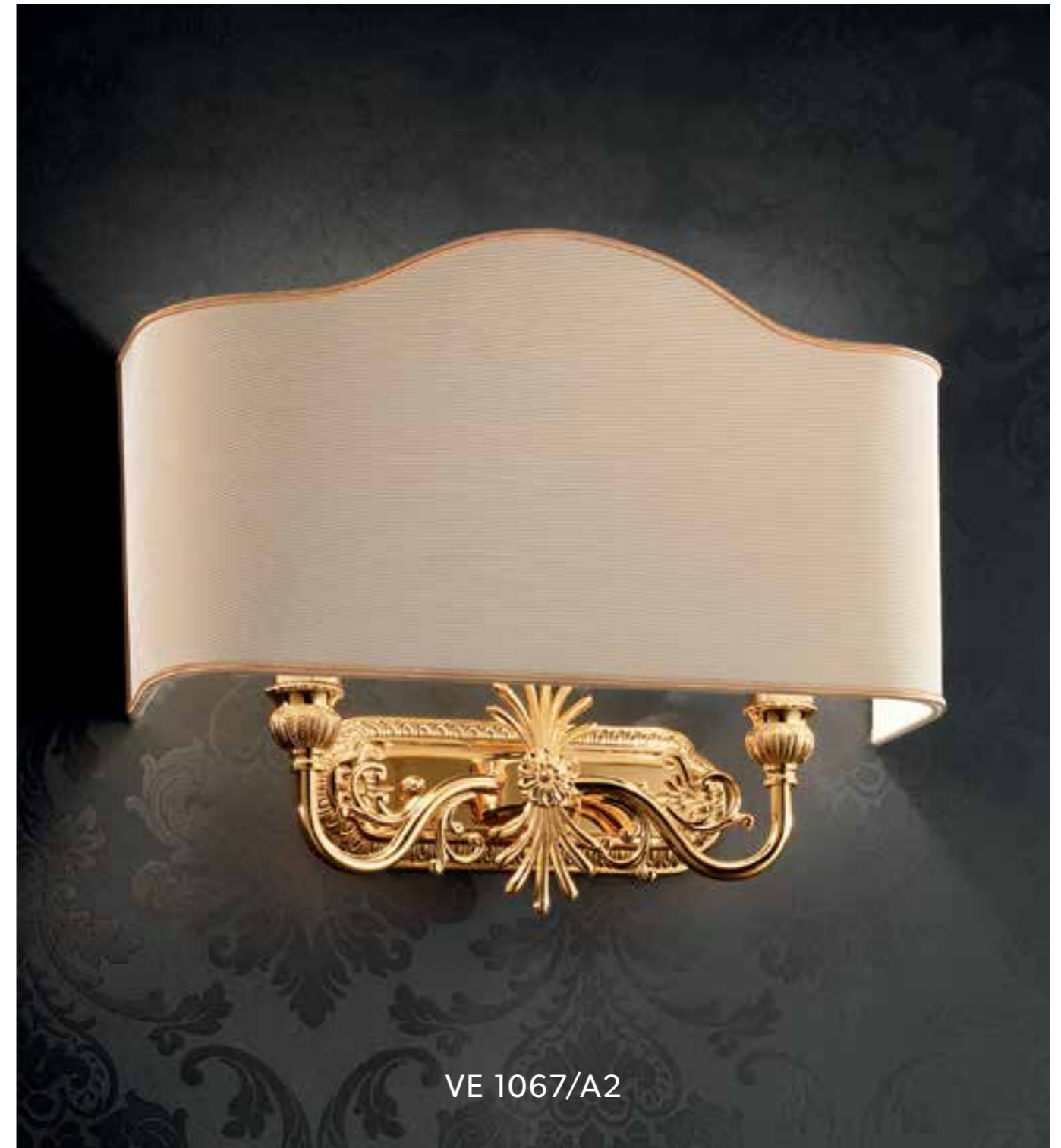
WW 1×E14×40 W max(not included)
 USA 1×E12×40 W max(not included)



VE 1002/A1



VE 1063/A2

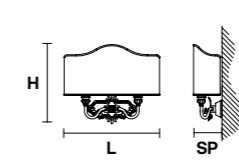
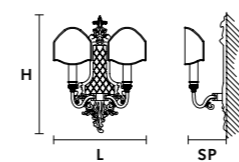


VE 1067/A2

VE 1063/A2



VE 1067/A2



L 30 cm / 11.81"
 SP 16 cm / 6.30"
 H 41 cm / 16.41"
 W 5 kg / 11.02 lb

L 37 cm / 14.57"
 SP 11 cm / 4.33"
 H 27 cm / 10.63"
 W 3 kg / 6.61 lb

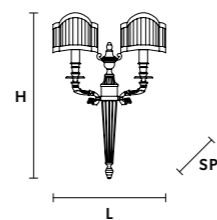
WW 2×E14×40 W max (not included)
 USA 2×E12×40 W max (not included)

WW 2×E14×40 W max (not included)
 USA 2×E12×40 W max (not included)



VE 1072/A2

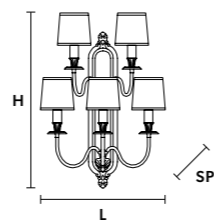
VE 1072/A2



L 40 cm / 15.75"
 SP 18 cm / 7.09"
 H 70 cm / 27.56"
 W 3 kg / 6.61 lb

WW 2×E14×40 W max(not included)
 USA 2×E12×40 W max(not included)

VE 1074/A5



L 55 cm / 21.65"
 SP 35 cm / 13.78"
 H 65 cm / 25.59"
 W 5 kg / 11.02 lb

WW 5×E14×40 W max(not included)
 USA 5×E12×40 W max(not included)




VE 1074/A5

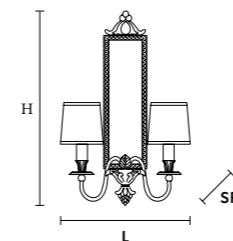


VE 1076/A2




VE 1078/A2

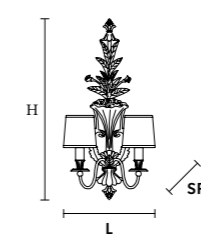
VE 1076/A2 



L 35 cm / 13.78"
SP 18 cm / 7.09"
H 60 cm / 23.62"
W 4 kg / 8.81 lb

WW 2×E14×40 W max (not included)
USA 2×E12×40 W max (not included)

VE 1078/A2 



L 40 cm / 15.75"
SP 25 cm / 9.84"
H 75 cm / 29.53"
W 4 kg / 8.81 lb

WW 2×E14×40 W max (not included)
USA 2×E12×40 W max (not included)

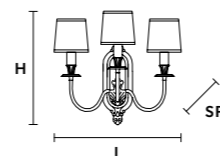
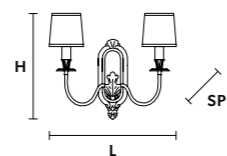


VE 1074/A2

VE 1074/A2



VE 1074/A3



L 40 cm / 15.75"
SP 18 cm / 7.09"
H 40 cm / 15.75"
W 3 kg / 6.61 lb

WW 2×E14×40 W max (not included)
USA 2×E12×40 W max (not included)

L 40 cm / 15.75"
SP 30 cm / 11.81"
H 45 cm / 17.72"
W 3.5 kg / 7.71 lb

WW 3×E14×40 W max (not included)
USA 3×E12×40 W max (not included)



VE 1074/A3



VE 1075/A2

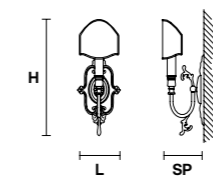
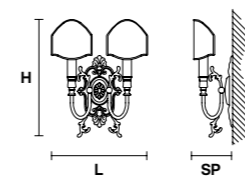


VE 1075/A1

VE 1075/A2



VE 1075/A1

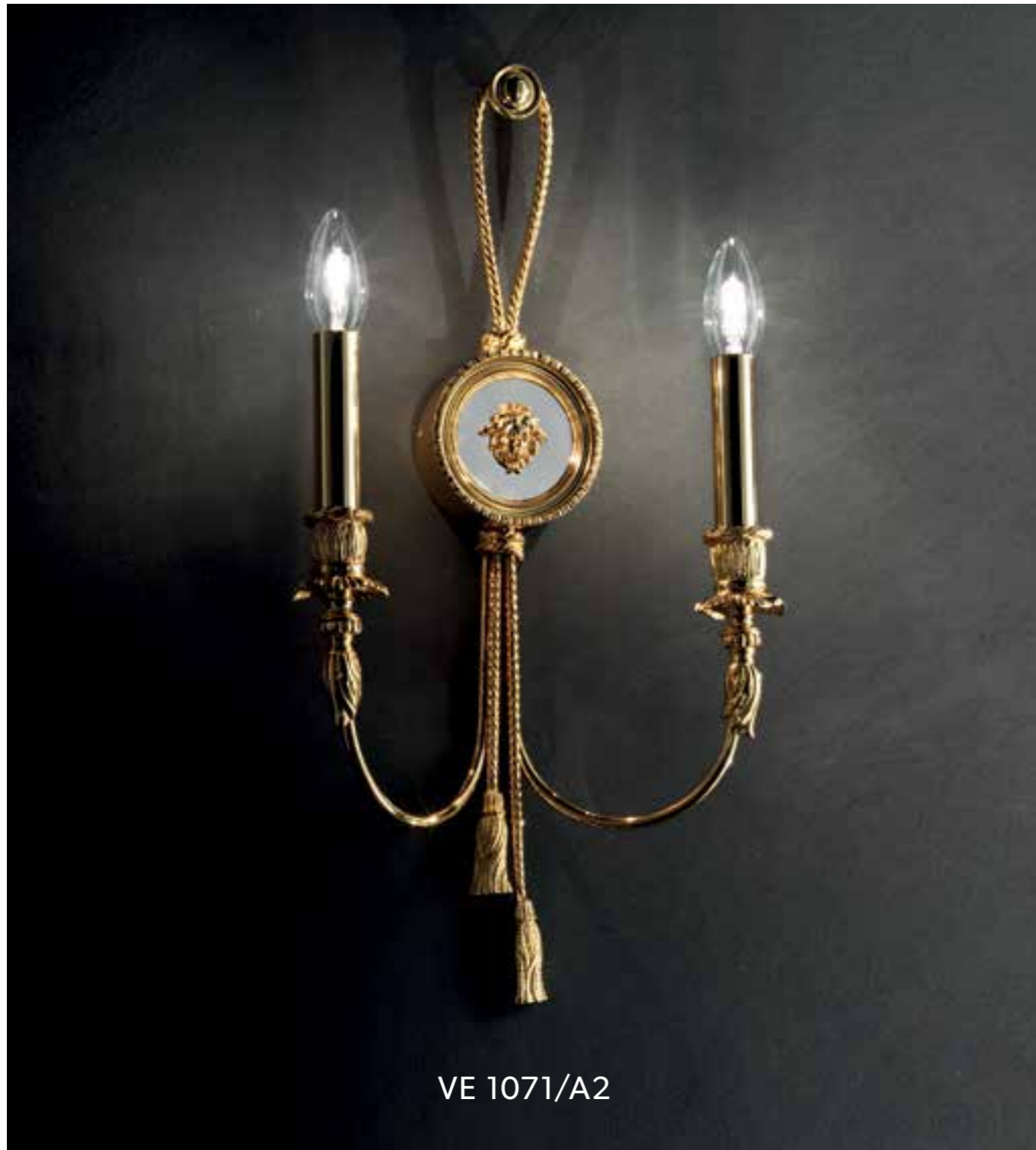


L 28 cm / 11.02"
SP 12.5 cm / 4.92"
H 33 cm / 12.99"
W 3 kg / 6.61 lb

WW 2×E14×40 W max (not included)
USA 2×E12×40 W max (not included)

L 13 cm / 5.12"
SP 14 cm / 5.51"
H 33 cm / 12.99"
W 2.2 kg / 4.85 lb

WW 1×E14×40 W max (not included)
USA 1×E12×40 W max (not included)

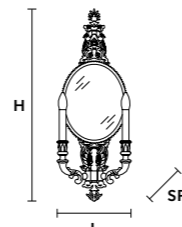
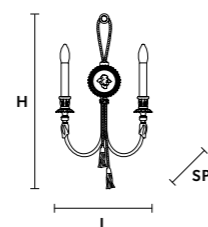


VE 1071/A2

VE 1071/A2



VE 1077/A2



L 30 cm / 11.81"
SP 12 cm / 4.72"
H 55 cm / 21.65"
W 2.2 kg / 4.8 lb

WW 2×E14×40 W max (not included)
USA 2×E12×40 W max (not included)

L 22 cm / 8.66"
SP 12 cm / 4.72"
H 60 cm / 23.62"
W 3 kg / 6.61 lb

WW 2×E14×40 W max (not included)
USA 2×E12×40 W max (not included)



VE 1077/A2



VE 1073/A2

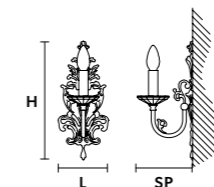
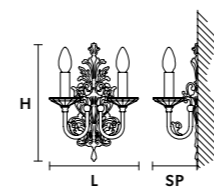


VE 1073/A1

VE 1073/A2



VE 1073/A1

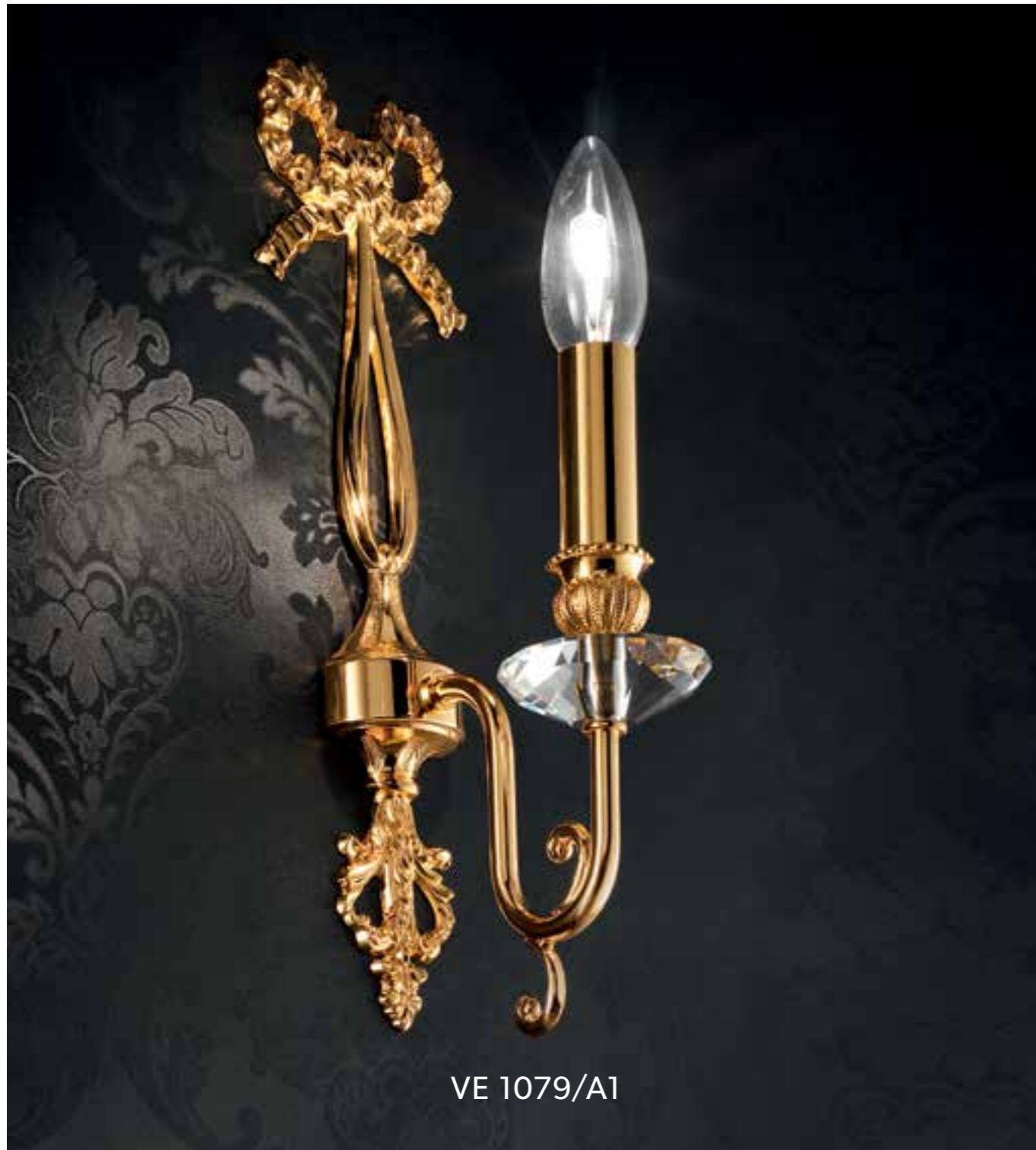


L 22 cm / 8.66"
 SP 12 cm / 4.72"
 H 33 cm / 12.99"
 W 5 kg / 11.02 lb

WW 2×E14×40 W max (not included)
 USA 2×E12×40 W max (not included)

L 15 cm / 5.91"
 SP 15 cm / 5.91"
 H 33 cm / 12.99"
 W 3 kg / 6.61 lb

WW 1×E14×40 W max (not included)
 USA 1×E12×40 W max (not included)

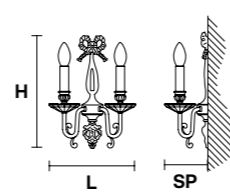
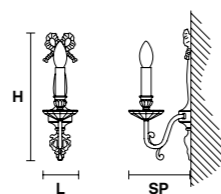


VE 1079/A1

VE 1079/A1



VE 1079/A2



L 10 cm / 3.94"
SP 16 cm / 6.30"
H 36 cm / 14.17"
W 2.2 kg / 4.85 lb

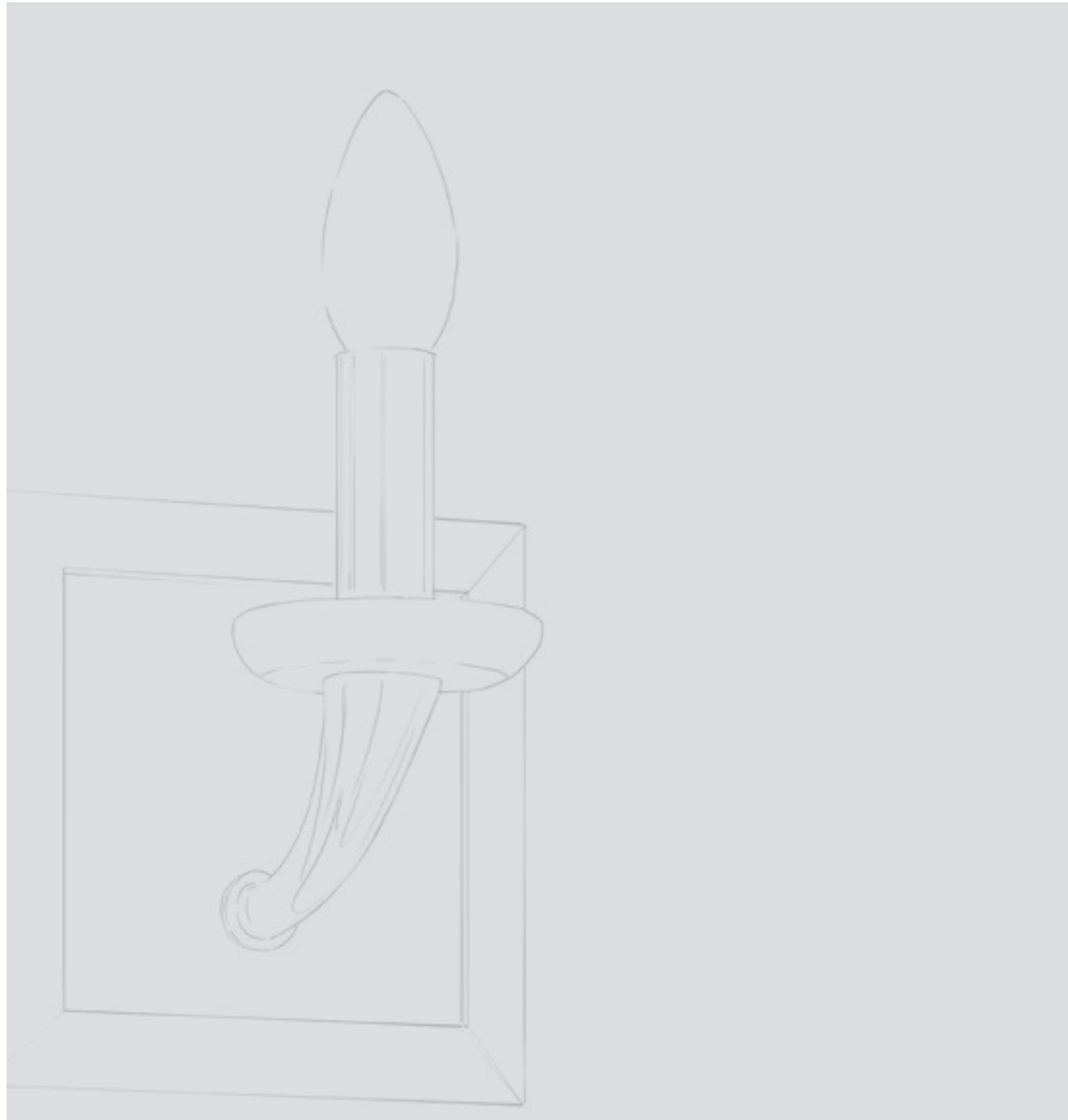
L 23 cm / 9.06"
SP 12 cm / 4.72"
H 36 cm / 14.17"
W 3 kg / 6.61 lb

WW 1x E14x40 W max (not included).
USA 1x E12x40 W max (not included)

WW 2x E14x40 W max (not included).
USA 2x E12x40 W max (not included)



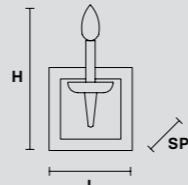
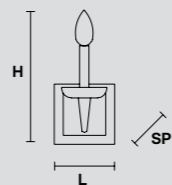
VE 1079/A2



VE 1192/A1 P



VE 1192/A1 G



L 11 cm / 4.33"
SP 14 cm / 5.51"
H 24 cm / 9.44"
W 1.5 kg / 3.30 lb

WW 1xE14x40 W max (not included)
USA 1xE12x40 W max (not included)

L 16 cm / 6.30"
SP 14 cm / 5.51"
H 26 cm / 10.23"
W 3 kg / 6.61 lb

WW 1xE14x40 W max (not included)
USA 1xE12x40 W max (not included)



VE 1192/A1 G

VE 1192/A1 P



VE 1090/A1

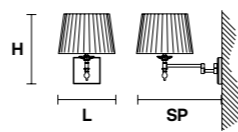
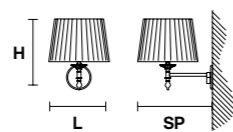


VE 1091/A1

VE 1090/A1



VE 1091/A1



L 20 cm / 7.87"
SP 34 cm / 13.39"
H 30 cm / 11.81"
W 3 kg / 6.61 lb

WW 1x E27x60 W max (not included).
USA 1x E26x60 W max (not included)

L 26 cm / 10.24"
SP 48 cm / 18.90"
H 30 cm / 11.81"
W 3 kg / 6.61 lb

WW 1x E27x60 W max (not included).
USA 1x E26x60 W max (not included)



VE 1090/STL1

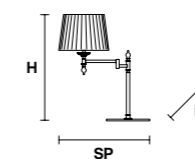
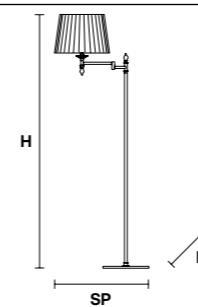


VE 1090/TL1

VE 1090/STL



VE 1090/TL1

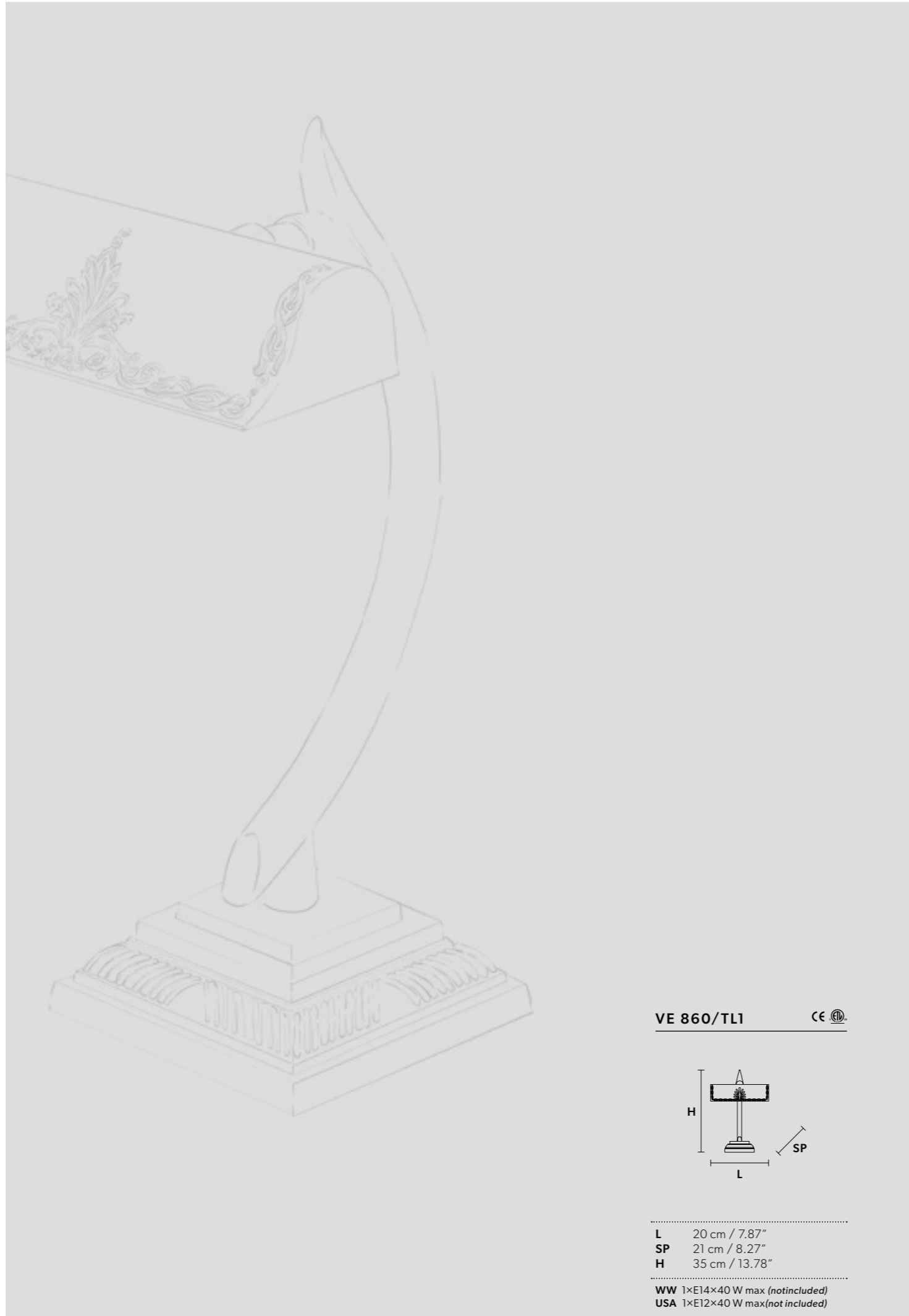


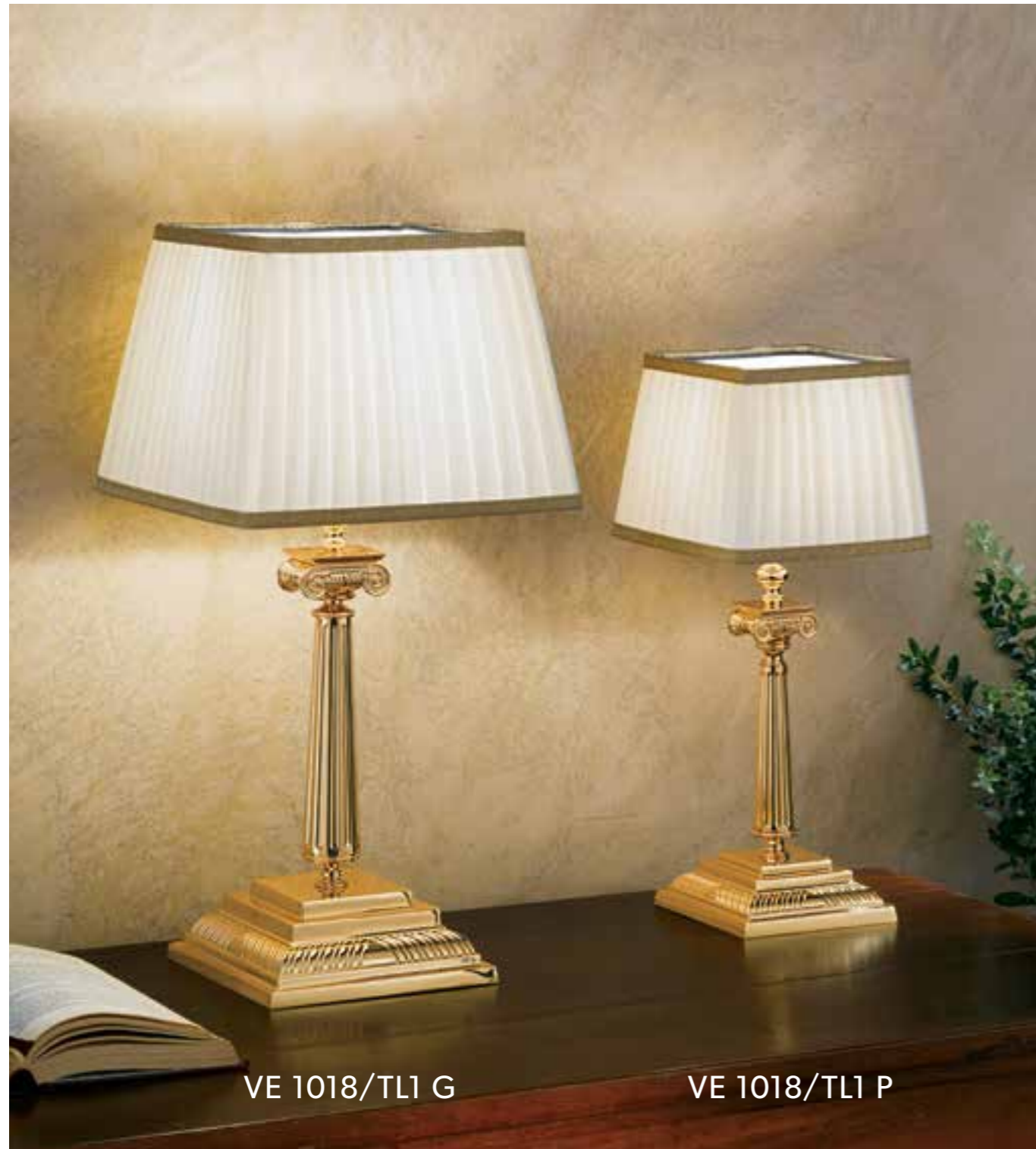
L 36 cm / 14.17"
 SP 70 cm / 27.56"
 H 168 cm / 66.14"

L 30 cm / 11.81"
 SP 70 cm / 27.56"
 H 64 cm / 25.20"

WW 1×E27×60 W max (not included)
 USA 1×E26×60 W max (not included)

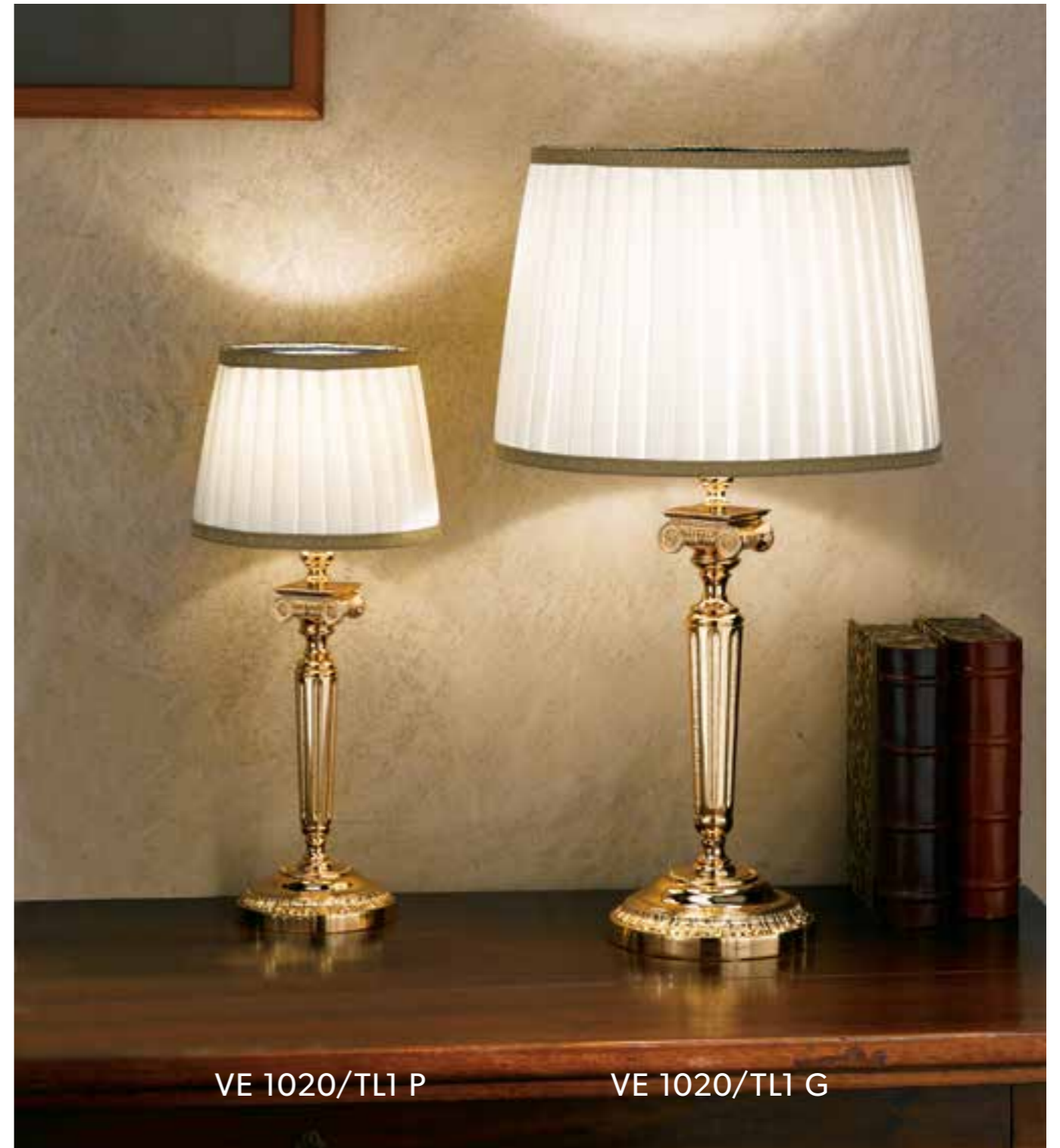
WW 1×E27×60 W max (not included)
 USA 1×E26×60 W max (not included)





VE 1018/TL1 G

VE 1018/TL1 P



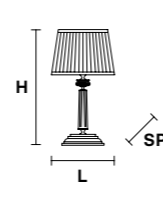
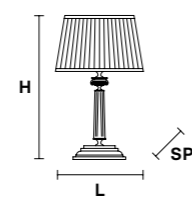
VE 1020/TL1 P

VE 1020/TL1 G

VE 1018/TL1 G



VE 1018/TL1 P



L 25 cm / 9.84"
SP 25 cm / 9.84"
H 51 cm / 20.08"

WW 1×E27×60 W max (not included)
USA 1×E26×60 W max (not included)

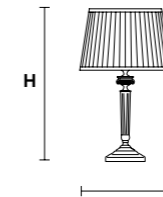
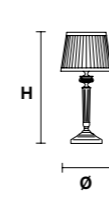
L 17 cm / 6.69"
SP 17 cm / 6.69"
H 41 cm / 16.14"

WW 1×E14×40 W max (not included)
USA 1×E12×40 W max (not included)

VE 1020/TL1 P



VE 1020/TL1 G



Ø 18 cm / 7.09"
H 40 cm / 15.75"

WW 1×E14×40 W max (not included)
USA 1×E12×40 W max (not included)

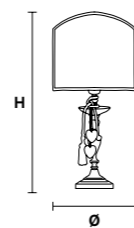
Ø 30 cm / 11.81"
H 54 cm / 21.26"

WW 1×E27×60 W max (not included)
USA 1×E26×60 W max (not included)



VE 1002/TL1

VE 1002/TL1 



Ø 25 cm / 9.84"
 H 55 cm / 21.65"


WW 1x E27x60 W max (not included)
 USA 1x E26x60 W max (not included)

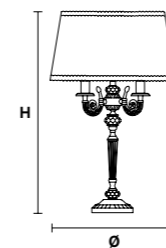


VE 1086/TL3



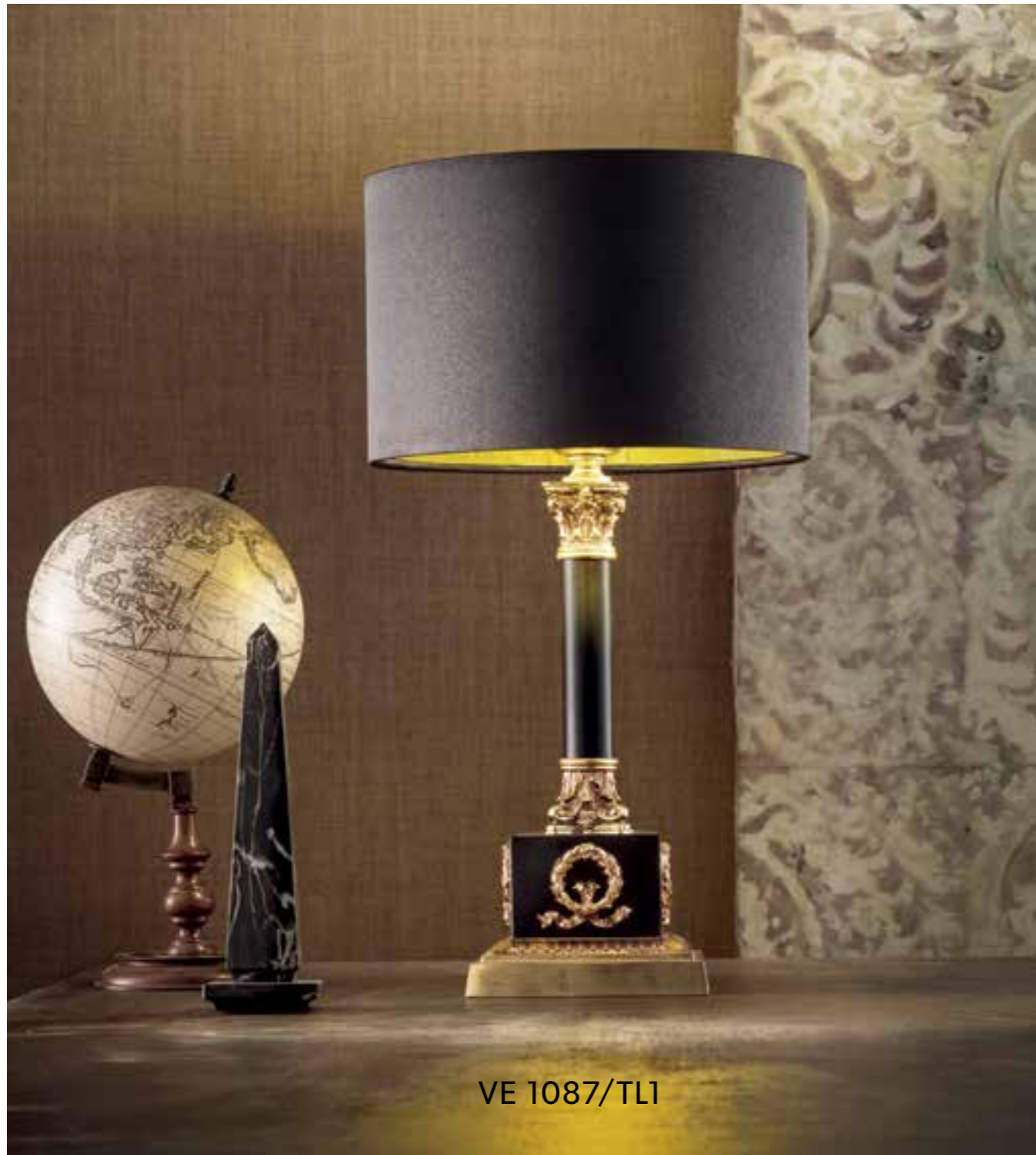
VE 1086/TL3

VE 1086/TL3 



Ø 40 cm / 15.75"
 H 65 cm / 25.59"

WW 3×E14×40 W max (not included)
 USA 3×E12×40 W max(not included)

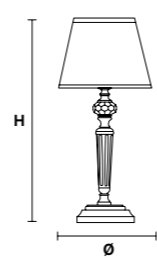
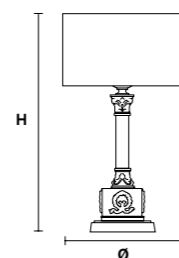


VE 1087/TL1

VE 1087/TL1

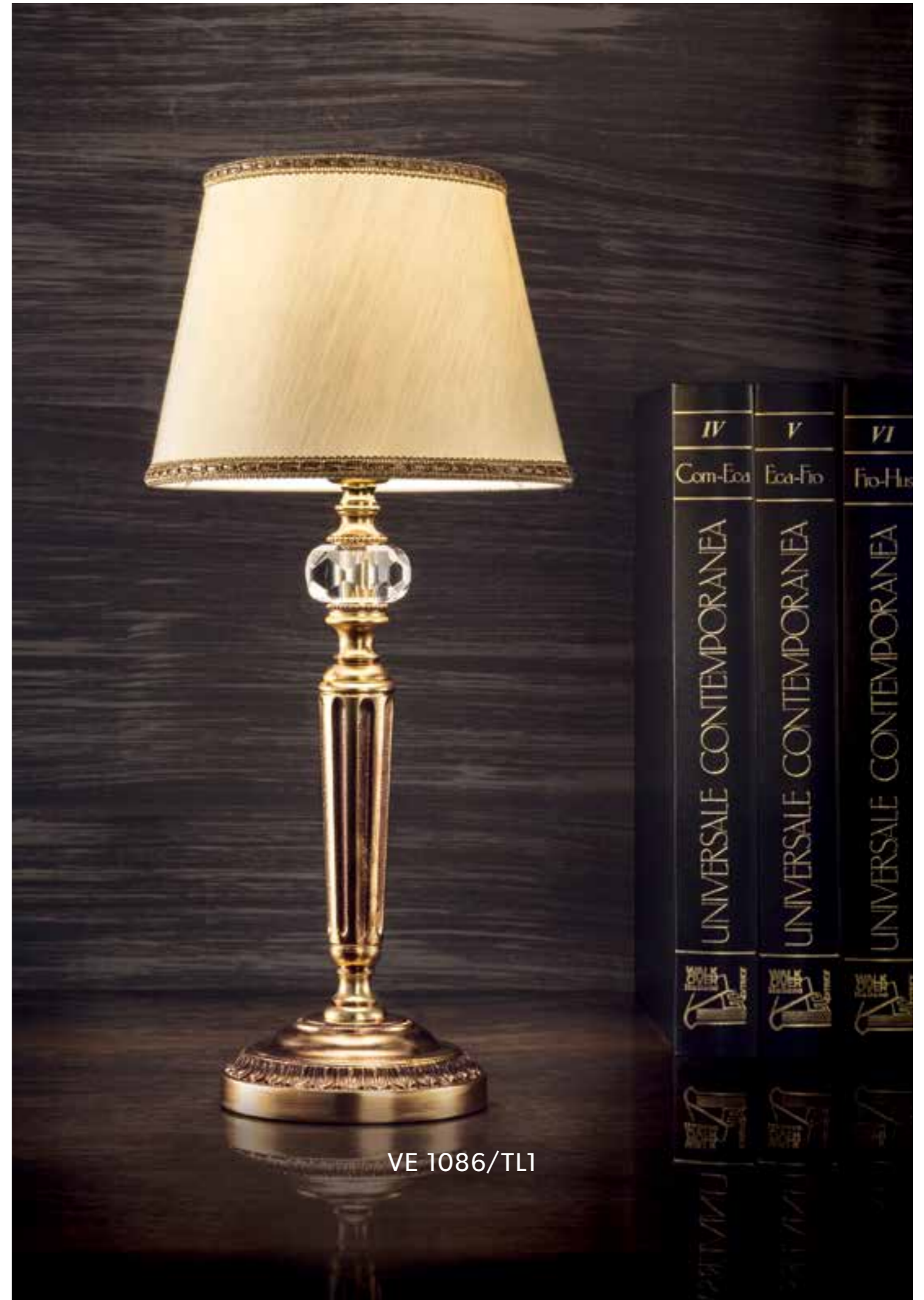


VE 1086/TL1

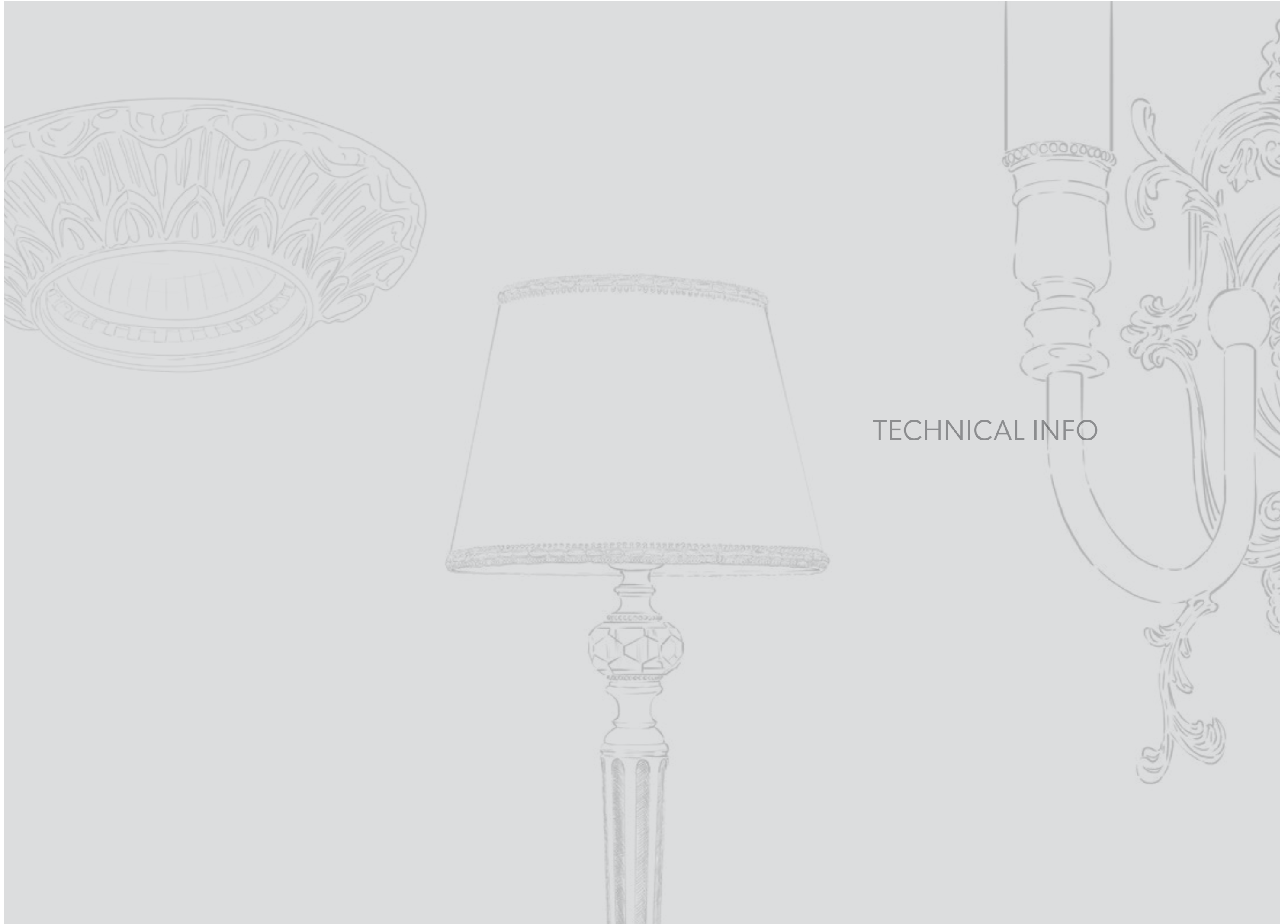


Ø 25 cm / 9.84"
H 41 cm / 16.14"
W 1.8 kg / 3.97 lb
WW 1x E27x60 W max (not included)
USA 1x E26x60 W max (not included)

Ø 18 cm / 7.09"
H 38 cm / 14.96"
W 1.2 kg / 2.64 lb
WW 1x E14x40 W max (not included)
USA 1x E12x40 W max (not included)



VE 1086/TL1



TECHNICAL INFO

FINITURE / FINISHING

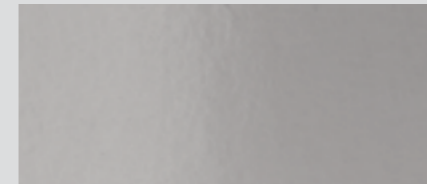
Bagno galvanico / Galvanic Bath



G07 Nickel spazzolato
Brushed nickel



G06 Cromo opaco
Matt chrome



G04 Cromo lucido
Shiny chrome



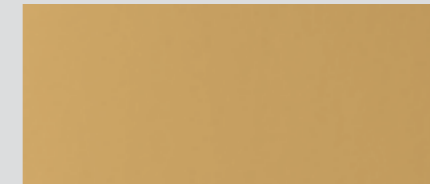
G21 Cromo anticato
Antiqued chrome



G14 Ottone brunito
Burnished brass



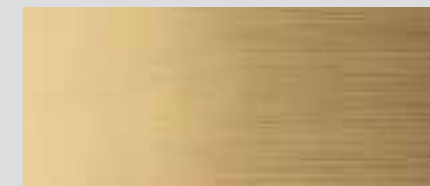
G01 Brunito
Burnished



G05 Oro opaco
Matt gold



G03 Oro lucido
Shiny gold



G12 Oro spazzolato
Brushed gold



G20 Oro anticato
Antiqued gold



G18 Ottone spazzolato
Brushed brass

Verniciati / Painted



V71 Nickel opaco verniciato
Painted matt nickel



V93 Oro verniciato
Painted gold

Verificare la disponibilità di ciascuna finitura per specifici articoli / Availability of each finish to be confirmed for specific items.

Indice/Index

COD.	Ø/L-SP	H	PAG.
VE 852	Ø 10 cm		5
VE 853	L 10 - L 10 cm		7
VE 854	Ø 12 cm		6
VE 855	L 10 - L 10 cm		8
VE 856	Ø 10 cm		5
VE 856/G	Ø 16 cm		11
VE 857	Ø 12 cm		6
VE 858/A1P	L 20 - SP 20 cm	H 15 cm	32
VE 858/A2 G	L 30 - SP 20 cm	H 15 cm	32
VE 858/A4	L 60 - SP 20 cm	H 15 cm	33
VE 859	L 10 - L 10 cm		17
VE 860/ A1 P	L 20 - SP 26 cm	H 15 cm	36
VE 860/ A2 G	L 31 - SP 26 cm	H 15 cm	37
VE 860/ A4	L 60 - SP 26 cm	H 15 cm	39
VE 860/ TL1	L 20 - SP 21 cm	H 35 cm	65
VE 865	Ø 8 cm		10
VE 866	Ø 8 cm		10
VE 868/G	L 31 - SP 15 cm	H 10 cm	35
VE 868/P	L 12 - SP 15 cm	H 15 cm	34
VE 1002/A1	L 20 - SP 15 cm	H 55 cm	41
VE 1002/TL1	Ø 25 cm	H 55 cm	69
VE 1018/TL1 G	L 25 - SP 25 cm	H 51 cm	66
VE 1018/TL1 P	L 17 - SP 17 cm	H 41 cm	66
VE 1020/ TL1 G	Ø 30 cm	H 54 cm	67
VE 1020/ TL1 P	Ø 18 cm	H 40 cm	67
VE 1063/A2	L 30 - SP 16 cm	H 41 cm	42
VE 1065/A2	L 37 - SP 11 cm	H 28 cm	40
VE 1066/ A3	L 20 - SP 30 cm	H 48 cm	31
VE 1066/ S3	Ø 20 cm	H 44 cm	29
VE 1066/ S4	Ø 44 cm	H 85 cm	29
VE 1066/ S6	Ø 62 cm	H 120 cm	28
VE 1067/A2	L 37 - SP 11 cm	H 27 cm	43
VE 1069/S4	Ø 42 cm	H 44 cm	27
VE 1071/A2	L 30 - SP 12 cm	H 55 cm	52
VE 1072/A2	L 40 - SP 18 cm	H 70 cm	44
VE 1073/A1	L 15 - SP 15 cm	H 33 cm	55
VE 1073/A2	L 22 - SP 12 cm	H 33 cm	54

COD.	Ø/L-SP	H	PAG.
VE 1074/A2	L 40 - SP 18 cm	H 40 cm	48
VE 1074/A3	L 40 - SP 30 cm	H 45 cm	49
VE 1074/A5	L 55 - SP 35 cm	H 65 cm	45
VE 1075/A1	L 13 - SP 14 cm	H 33 cm	51
VE 1075/A2	L 28 - SP 12,5 cm	H 33 cm	50
VE 1076/A2	L 35 - SP 18 cm	H 60 cm	46
VE 1077/A2	L 22 - SP 12 cm	H 60cm	53
VE 1078/A2	L 40 - SP 25 cm	H 75 cm	47
VE 1079/A1	L 10 - SP 16 cm	H 36 cm	56
VE 1079/A2	L 23 - SP 12 cm	H 36 cm	57
VE 1080/ PL1	Ø 16 cm	H 12 cm	13
VE 1080/ PL3 40	Ø 40 cm	H 15 cm	20
VE 1080/ PL3 50	Ø 50 cm	H 15 cm	21
VE 1081/ PL1	Ø 16 cm	H 12 cm	13
VE 1081/ PL3 40	Ø 40 cm	H 12 cm	23
VE 1081/ PL3 50	Ø 50 cm	H 12 cm	22
VE 1081/ PL6	Ø 80 cm	H 17 cm	23
VE 1086/ TL1	Ø 18 cm	H 38 cm	73
VE 1086/ TL3	Ø 40 cm	H 65 cm	70-71
VE 1087/TL1	Ø 25 cm	H 41 cm	72
VE 1090/A1	L 20 - SP 34 cm	H 30 cm	60
VE 1090/STL1	L 36 - SP 70 cm	H 168 cm	62
VE 1090/TL1	L 30 - SP 70 cm	H 64 cm	63
VE 1091/A1	L 26 - SP 48 cm	H 30 cm	61
VE 1103	Ø 10 cm	H 2,8 cm	12
VE 1104	Ø 10 cm	H 3 cm	12
VE 1105	L 16 - SP 9 cm	H 5,5 cm	14
VE 1106	Ø 22 cm	H 2,5 cm	15
VE 1107/MC	Ø 9,5 cm	H 20 cm	25
VE 1107/TR	Ø 9,5 cm	H 20 cm	25
VE 1190	L 10 - L 10 cm		17
VE 1191	Ø 10 cm		16
VE 1192	Ø 10 cm		16
VE 1192/A1 G	L 16 - SP 14 cm	H 26 cm	59
VE 1192/A1 P	L 11 - SP 14 cm	H 24 cm	59
VE 1193	Ø 10 cm		19
VE 1194	Ø 10 cm		19

CE

Attesta la conformità del prodotto alle disposizioni delle Direttive comunitarie.

It certifies the conformity of the products to the European Community provisions.

Il atteste la conformité du produit aux dispositions des directives communaitaires.

Konformität des Produktes mit den Richtlinien der europäischen Gemeinschaft.

НАСТОЯЩИМ ПОДТВЕРЖДАЕТСЯ СООТВЕТСТВИЕ ПРОДУКЦИИ ПОЛОЖЕНИЯМ ДИРЕКТИВ ЕС.

Certifica la conformidad del producto según las disposiciones de las directivas comunitarias.

CE标记是指产品的制造商证明该产品符合适用的EC指令的所有基本要求。

يُشهد بمطابقة المنتج لأحكام توجيهات المجتمع الأوروبي.



Il logo "ETL" si riferisce agli articoli che possono essere modificati con componenti certificati ETL. L'elenco degli articoli ETL si riferisce a prodotti testati e valutati in base agli standard di sicurezza del mercato statunitense. Per il mercato USA fare riferimento al listino dedicato.

"ETL" logos refers to articles which can be modified with ETL-compliance components. The "ETL" listing articles stands for tested and evaluated product to recognised US safety standards. For the US market, refer to the relevant price list.

"ETL" logo se réfère aux articles qui peuvent être modifiées par des composants certifiés ETL. la liste des articles ETL se réfère à des produits testés et évalués selon les normes de sécurité du marché américain. Pour le marché américain se référer à la liste des prix.

Das "ETL"-Logo bezieht sich auf Artikel, die mit ETL-zertifizierten Komponenten modifiziert werden können. Die Liste der ETL-Artikel bezieht sich auf Produkte, die nach den Sicherheitsstandards des US-Marktes getestet und bewertet wurden. Für den US-Markt beachten Sie bitte die entsprechende Preisliste.

ЛОГОТИП «ETL» ОТНОСИТСЯ К ЭЛЕМЕНТАМ, КОТОРЫЕ МОГУТ БЫТЬ МОДИФИЦИРОВАННЫ С ПОМОЩЬЮ СЕРТИФИЦИРОВАННЫХ ETL КОМПОНЕНТОВ. СПИСОК ЭЛЕМЕНТОВ ETL ОТНОСИТСЯ К ПРОДУКЦИИ, ПРОТЕСТИРОВАННОЙ И ОЦЕНЕННОЙ В СООТВЕТСТВИИ С ПРИЗНАННЫМИ СТАНДАРТАМИ БЕЗОПАСНОСТИ США. ДЛЯ ПОТРЕБИТЕЛЕЙ НАХОДЯЩИХСЯ В США СМ. СООТВЕТСТВУЮЩИЙ ПРАЙС-ЛИСТ.

El logo "ETL" indica los artículos, que pueden modificarse con componentes certificados ETL. La lista de los artículos ETL se refiere a los productos sometidos a prueba y evaluados en función de los estándares de seguridad del mercado estadounidense. Consultar la lista de precios específica para el mercado de los Estados Unidos.

"ETL" 徽标是指可以使用ETL认证的组件进行修改的项目。 ETL项目列表是指根据美国市场的安全标准进行测试和评估的产品。 对于美国市场, 请参考美国市场价格表。

يشير شعار «ETL» إلى المنتجات التي يمكن تعديلها باستخدام مكونات مُعتمدة من ETL. تشير قائمة منتجات ETL إلى المنتجات التي تم اختبارها وتقييمها وفقًا لمعايير السلامة في السوق الأمريكي. بالنسبة لسوق الولايات المتحدة الأمريكية، يُرجى الرجوع إلى قائمة الأسعار المُخصصة.

Im

Flusso luminoso nominale. L'indicazione si riferisce al valore in assenza di rifrazione, come dichiarato dal produttore del componente.

Nominal luminous flux. It refers to the value without any refraction, as declared by the component manufacturer.

L'unité SI de flux lumineux. L'indication correspond à la valeur en l'absence de réfraction, comme indiqué par le fabricant du composant.

Die Maßeinheit für den Lichtstrom. Die Angabe bezieht sich auf den Wert in der Abwesenheit von Brechung, wie vom Hersteller der Komponente angegeben.

НОМИНАЛЬНЫЙ СВЕТОВОЙ ПОТОК. УКАЗАНИЕ ОТНОСИТСЯ К ЗНАЧЕНИЮ В ОТСУТСТВИЕ РЕФРАКЦИИ, КАК ЗАЯВЛЕНО ПРОИЗВОДИТЕЛЕМ КОМПОНЕНТОВ.

Flujo luminoso nominal. La indicación se refiere al valor sin refracción, como declarado por el fabricante del componente.

标称光通量。指示是指组件制造商声明的没有折射的值。

التدفق الضوئي الاسمي. يشير المؤشر إلى القيمة في حالة عدم وجود انكسار للضوء، كما هو مُعلن من قبل الشركة المصنعة للعنصر.

MASIERO

Masiero si riserva il diritto di apportare ai propri articoli, senza nessun preavviso, qualsiasi modifica ritenesse opportuna.

Masiero reserves the right to introduce any changes to its own products, without notice in advance.

Masiero se réserve le droit d'apporter une quelconque modification à les modèles sans préavis.

Masiero behält sich das Recht vor Änderungen vorzunehmen, ohne sofortige Benachrichtigung.

КОМПАНИЯ MASIERO ОСТАВЛЯЕТ ЗА СОБОЙ ПРАВО БЕЗ ПРЕДВАРИТЕЛЬНОГО УВЕДОМЛЕНИЯ, ЕСЛИ ЭТО БУДЕТ СОЧТЕНО ЦЕЛЕСООБРАЗНЫМ, ВНОСИТЬ В СОБСТВЕННЫЕ МОДЕЛИ ЛЮБЫЕ ИЗМЕНЕНИЯ.

Masiero se reserva el derecho de aportar modificaciones consideradas oportunas a sus artículos sin preaviso.

Masiero 保留对其认为适当的任何更改的权利, 恕不另行通知。

تحتفظ شركة مازيرو "Masiero" بالحق في إجراء أي تعديلات تراها مناسبة على منتجاتها، دون إشعار مسبق.

Masiero srl

via Peschiere, 53
31032 Casale sul Sile
Treviso, Italy
T +39 0422 7861
F +39 0422 786250

info@masierogroup.com
masierogroup.com

Design by Masiero
Photo, Studio Pointer
Print Italy, April 2021
by Grafica Antiga



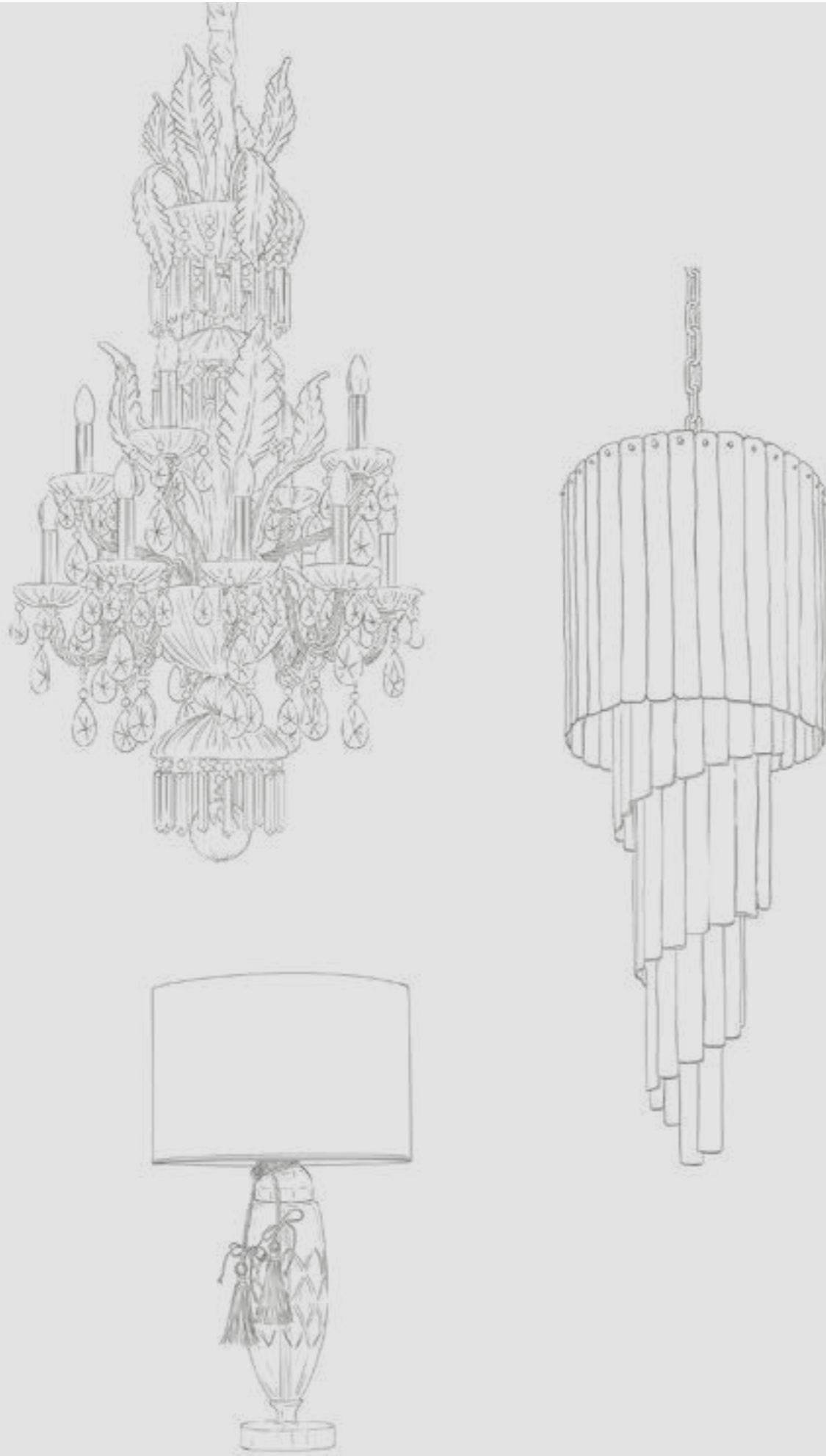
GLASS
ATELIER

MASIERO



GLASS
ATELIER

MASIERO



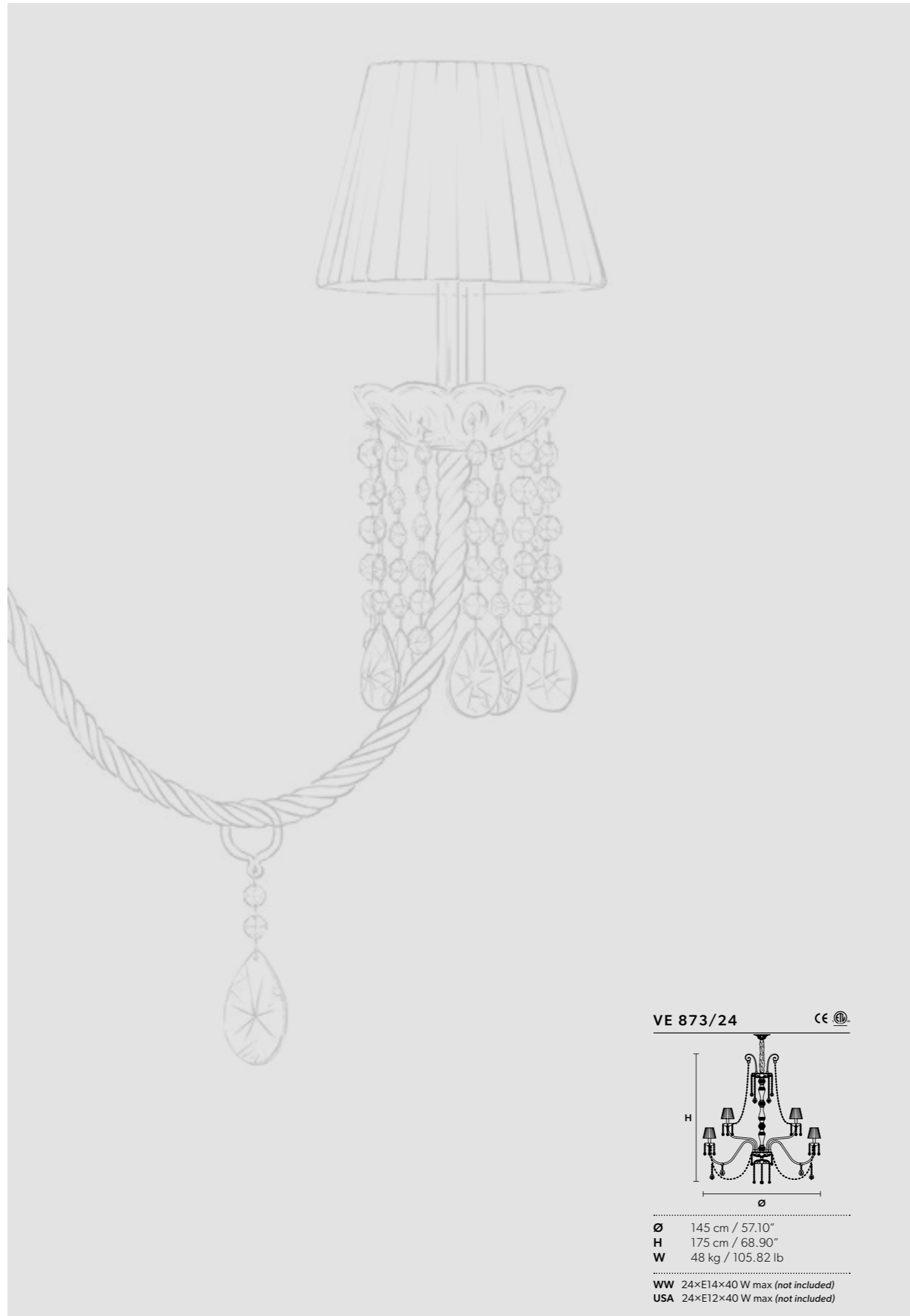
GLASS

L'antica arte vetraia veneziana tramanda la sua eccellenza nota in tutto il mondo.

L'originale tecnica della graniglia regala sorprendente profondità materica al vetro, creando un decoro volutamente mai uguale, che rende ogni pezzo unico.

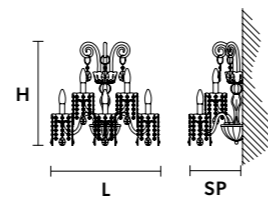
La tradizione dei lampadari di cristallo di Bohemia disegna grandi cadute in vetro, la cui trasparenza dona effetti luminosi unici.

The ancient art of Venetian glass perpetuates its excellence, famous throughout the world. The original graniglia technique gives the glass surprising depth and substance, with each piece made unique by a purposely ever-different decoration. Unique lighting effects are created by the large glass pendants in the tradition of Bohemia crystal chandeliers.





VE 873/A5 CE



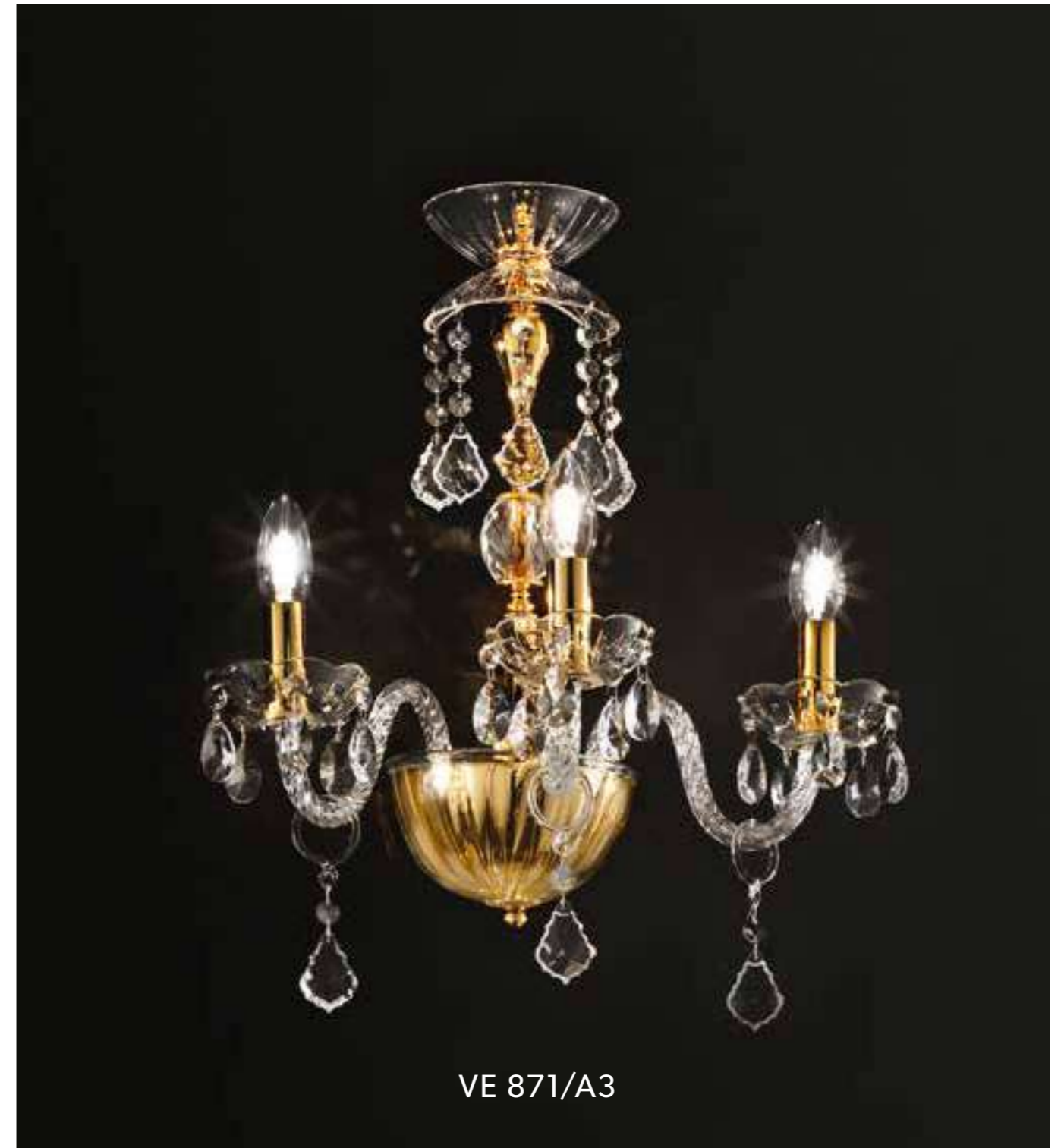
- L 53 cm / 20.90"
- SP 30 cm / 11.80"
- H 50 cm / 19.70"
- W 4.5 kg / 9.92lb

WW 5x E14x40 W max (not included)
 USA 5x E12x40 W max (not included)

VE 873/A5



VE 871/A5



VE 871/A3

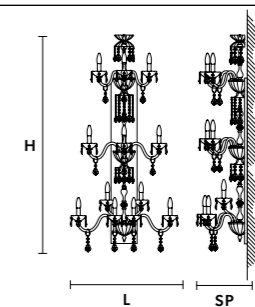
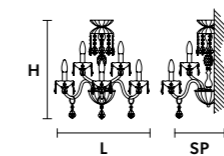
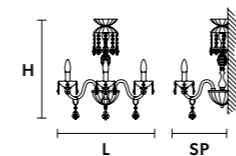
VE 871/A3



VE 871/A5



VE 871/A12



L 50 cm / 19.70"

SP 28 cm / 11.05"

H 54 cm / 21.25"

W 3 kg / 6.61 lb

WW 3×E14×40 W max (not included)
USA 3×E12×40 W max (not included)

L 50 cm / 19.70"

SP 28 cm / 11.05"

H 54 cm / 21.25"

W 4 kg / 8.81 lb

WW 5×E14×40 W max (not included)
USA 5×E12×40 W max (not included)

L 75 cm / 29.60"

SP 30 cm / 11.80"

H 140 cm / 55.20"

W 6 kg / 13.22 lb


WW 12×E14×40 W max (not included)
USA 12×E12×40 W max (not included)

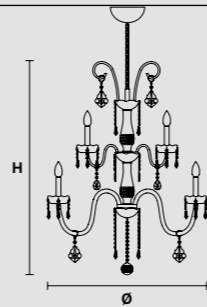


VE 871/32	CE	VE 871/64	CE
<p>Ø 110 cm / 43.30"</p> <p>H 270 cm / 106.30"</p> <p>W 64 kg / 110.23 lb</p>		<p>Ø 140 cm / 55.20"</p> <p>H 500 cm / 196.90"</p> <p>W 100 kg / 220.46 lb</p>	
<p>WW 32×E14×40 W max (not included)</p> <p>USA 32×E12×40 W max (not included)</p>		<p>WW 64×E14×40 W max (not included)</p> <p>USA 64×E12×40 W max (not included)</p>	

VE 871/32



VE 874/16+8 

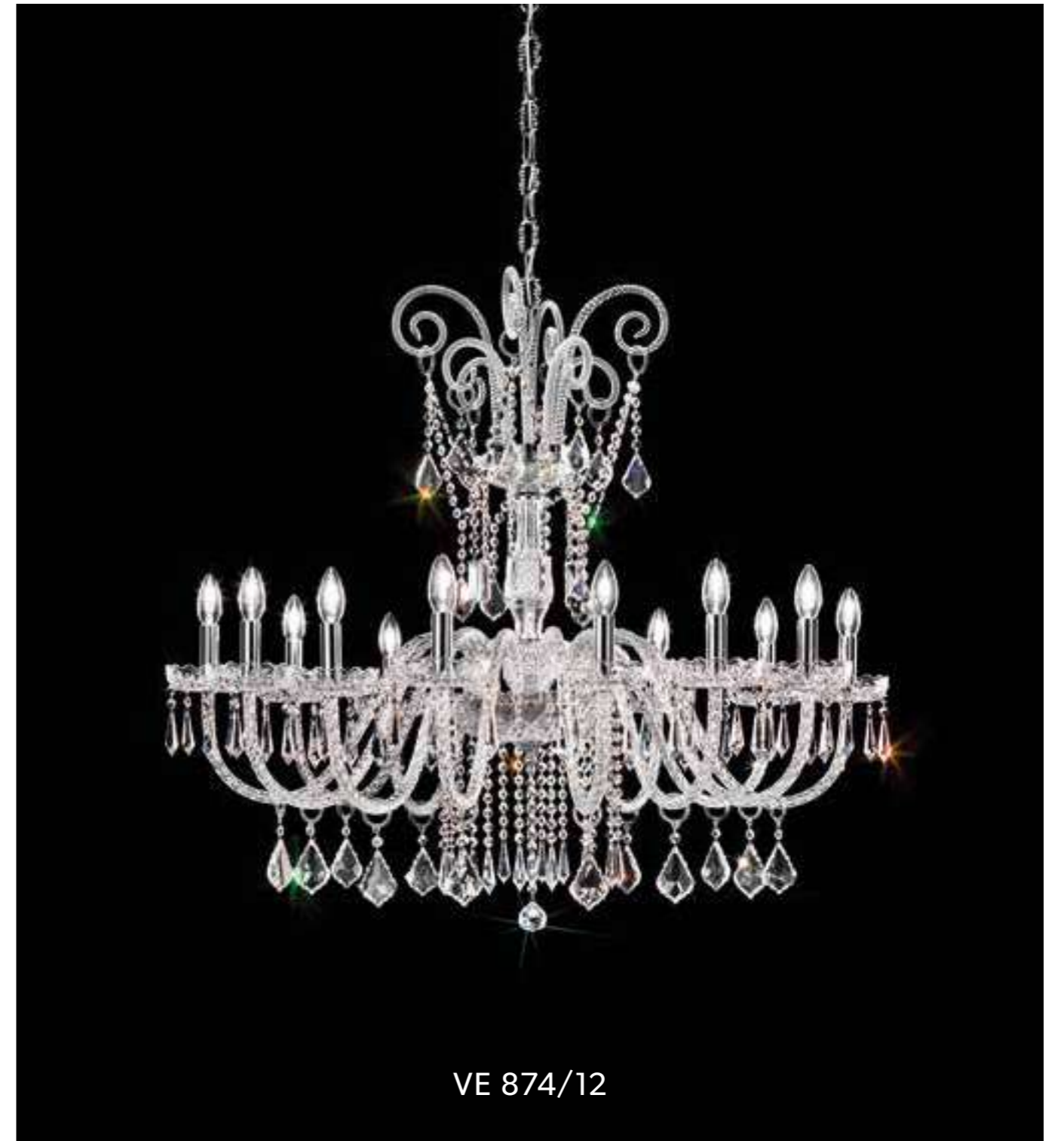


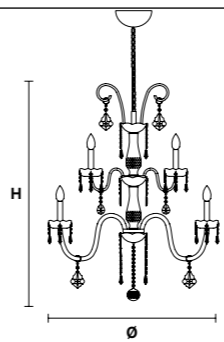
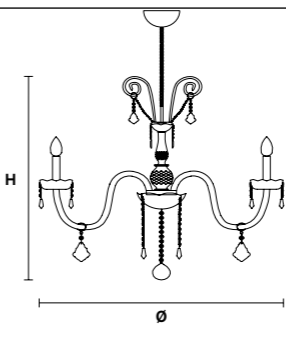
Ø 95 cm / 37.50"
H 110 cm / 43.30"
W 34 kg / 74.95 lb

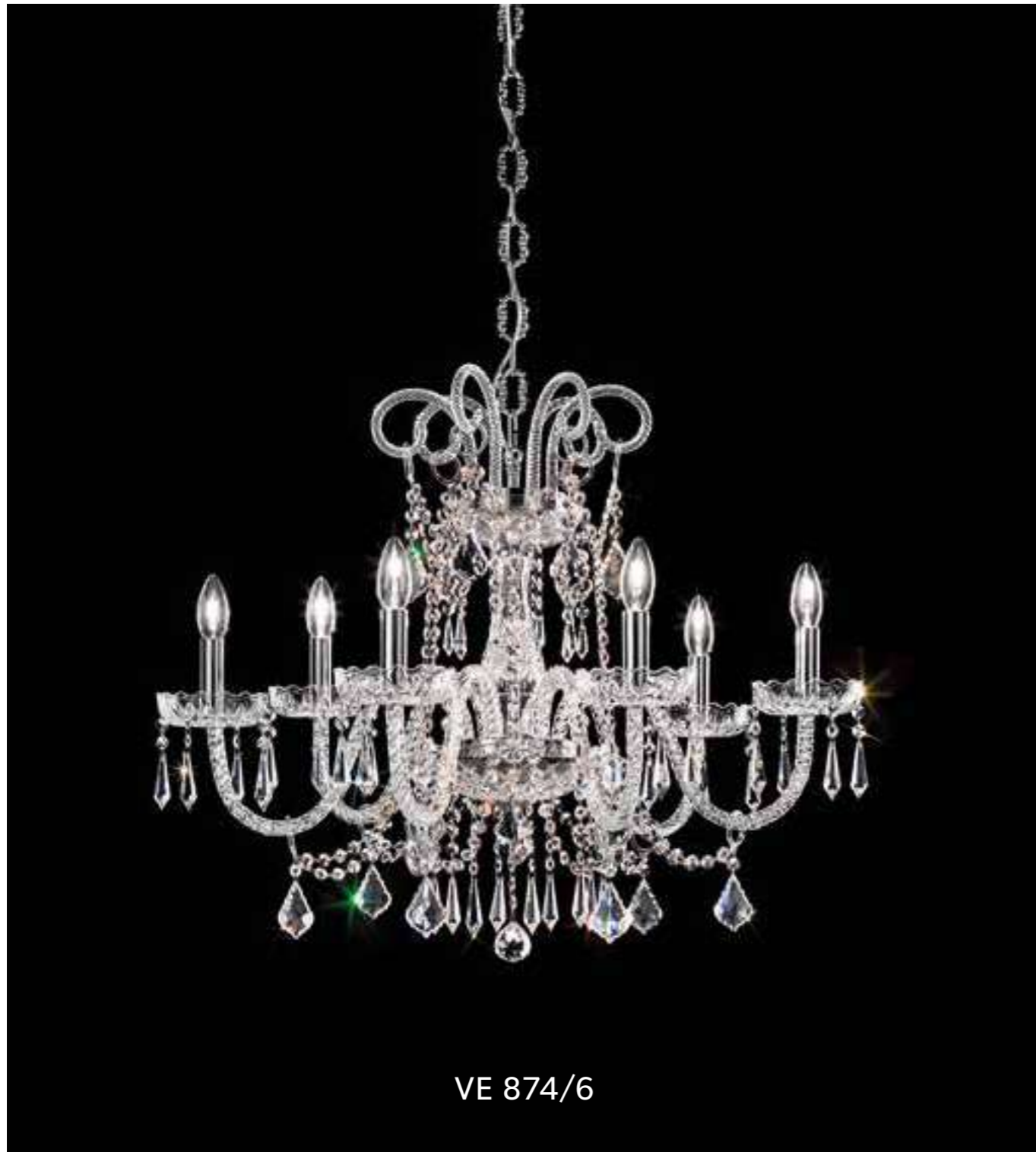
WW 24×E14×40 W max (not included)
USA 24×E12×40 W max (not included)



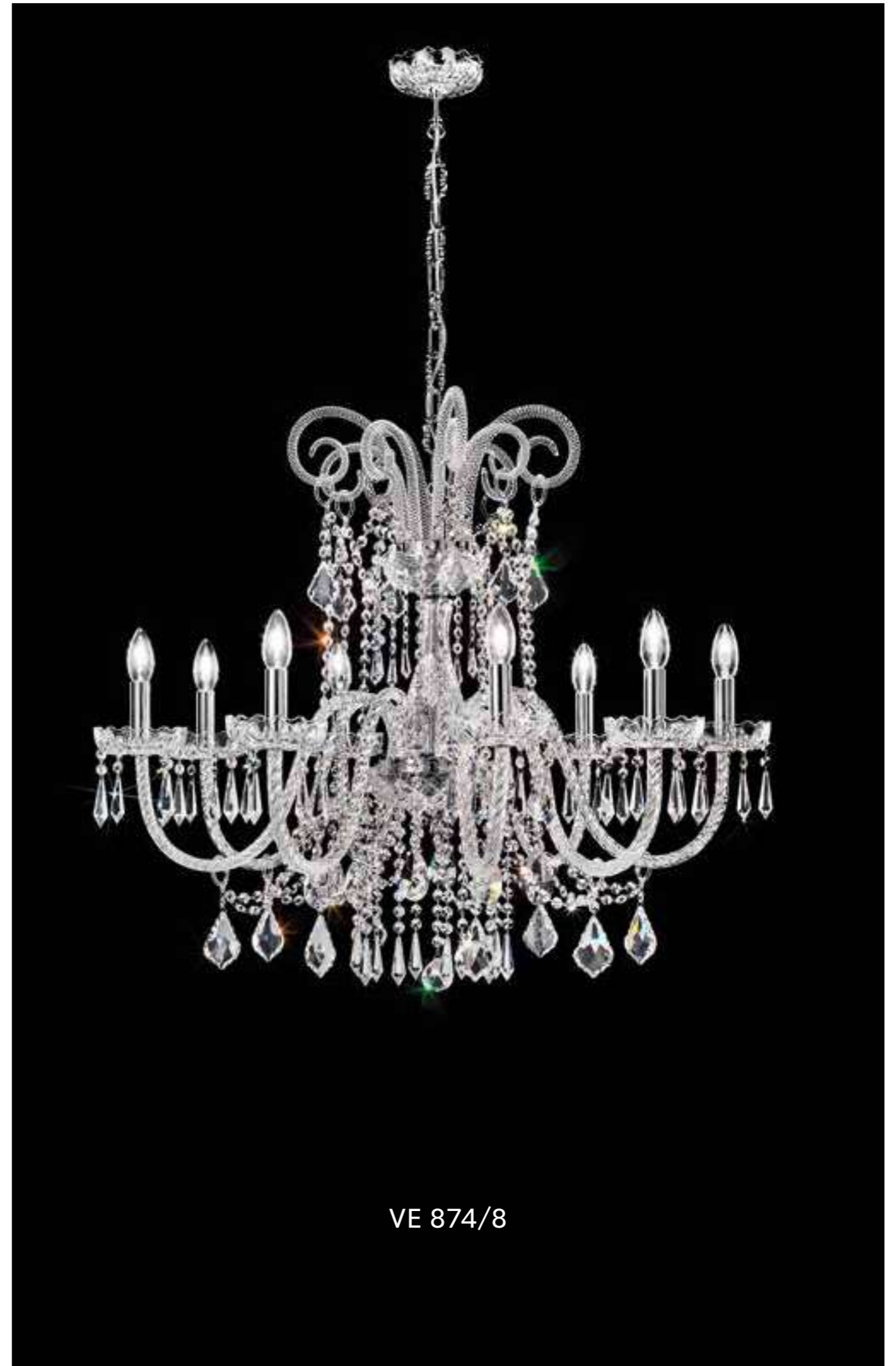
VE 874/16+8



VE 874/5+5	CE	VE 874/12	CE
			
Ø 88 cm / 34.64 "		Ø 103 cm / 40.55 "	
H 112 cm / 44.09 "		H 80 cm / 31.49 "	
W 19 kg / 41.88 lb		W 17 kg / 15.43 lb	
WW 10×E14×40 W max (not included)		WW 12×E14×40 W max (not included)	
USA 10×E12×40 W max (not included)		USA 12×E12×40 W max (not included)	

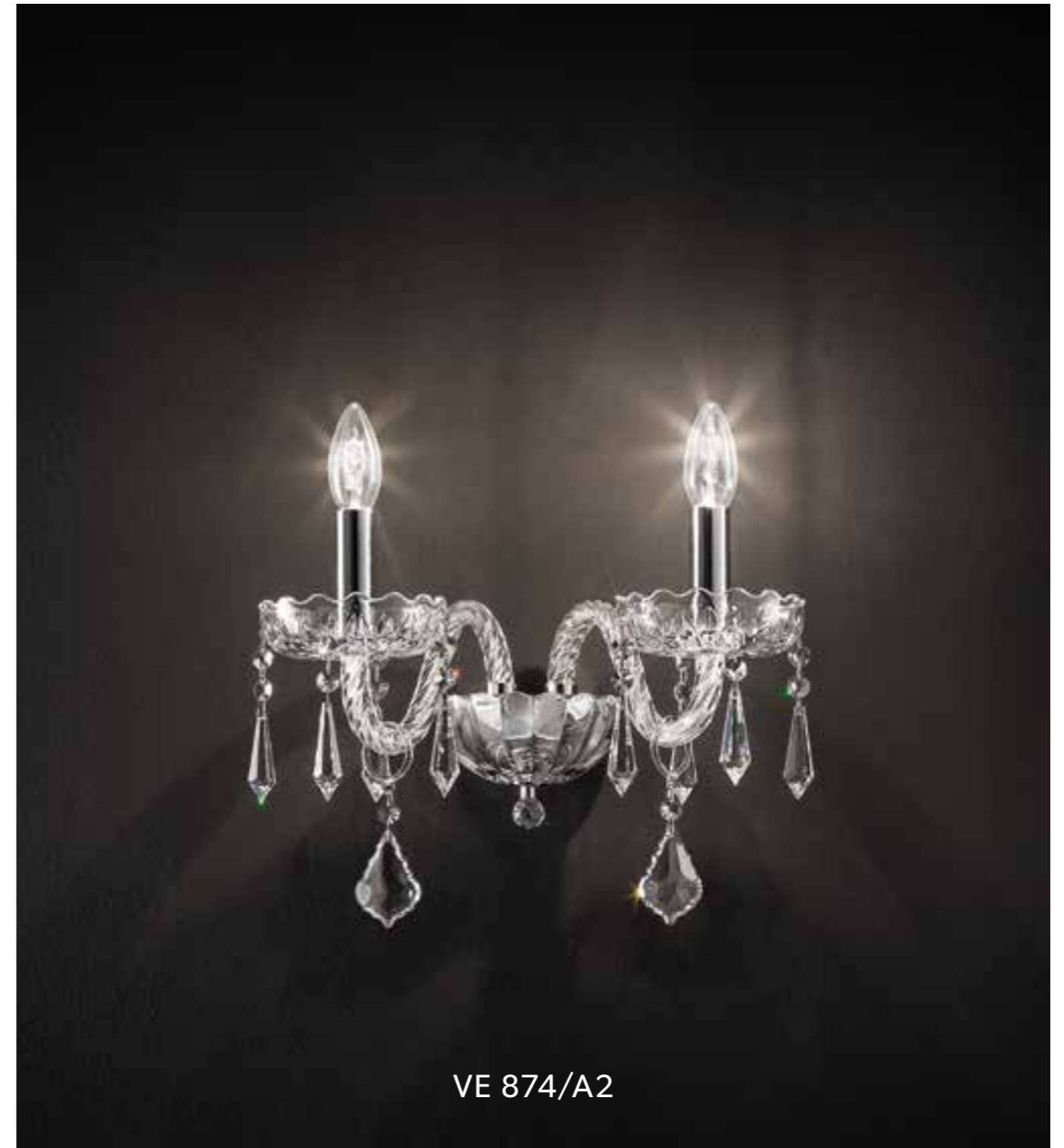


VE 874/6



VE 874/8

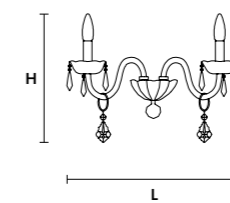
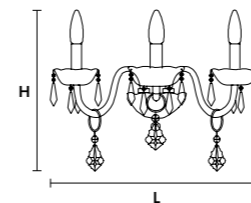
VE 874/6	CE	VE 874/8	CE
<p>Ø 77 cm / 30.31 "</p> <p>H 63 cm / 24.80 "</p> <p>W 9 kg / 19.84 lb</p>		<p>Ø 88 cm / 34.64 "</p> <p>H 76 cm / 29.92 "</p> <p>W 13 kg / 28.66 lb</p>	
<p>WW 6×E14×40 W max (not included)</p> <p>USA 6×E12×40 W max (not included)</p>		<p>WW 8×E14×40 W max (not included)</p> <p>USA 8×E12×40 W max (not included)</p>	



VE 874/A3



VE 874/A2



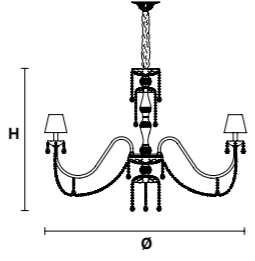
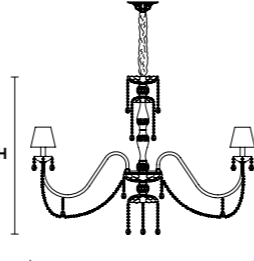
L 44 cm / 17.30"
 SP 26 cm / 10.25"
 H 26 cm / 10.25"
 W 3 kg / 6.61 lb

WW 3×E14×40 W max (not included)
 USA 3×E12×40 W max (not included)

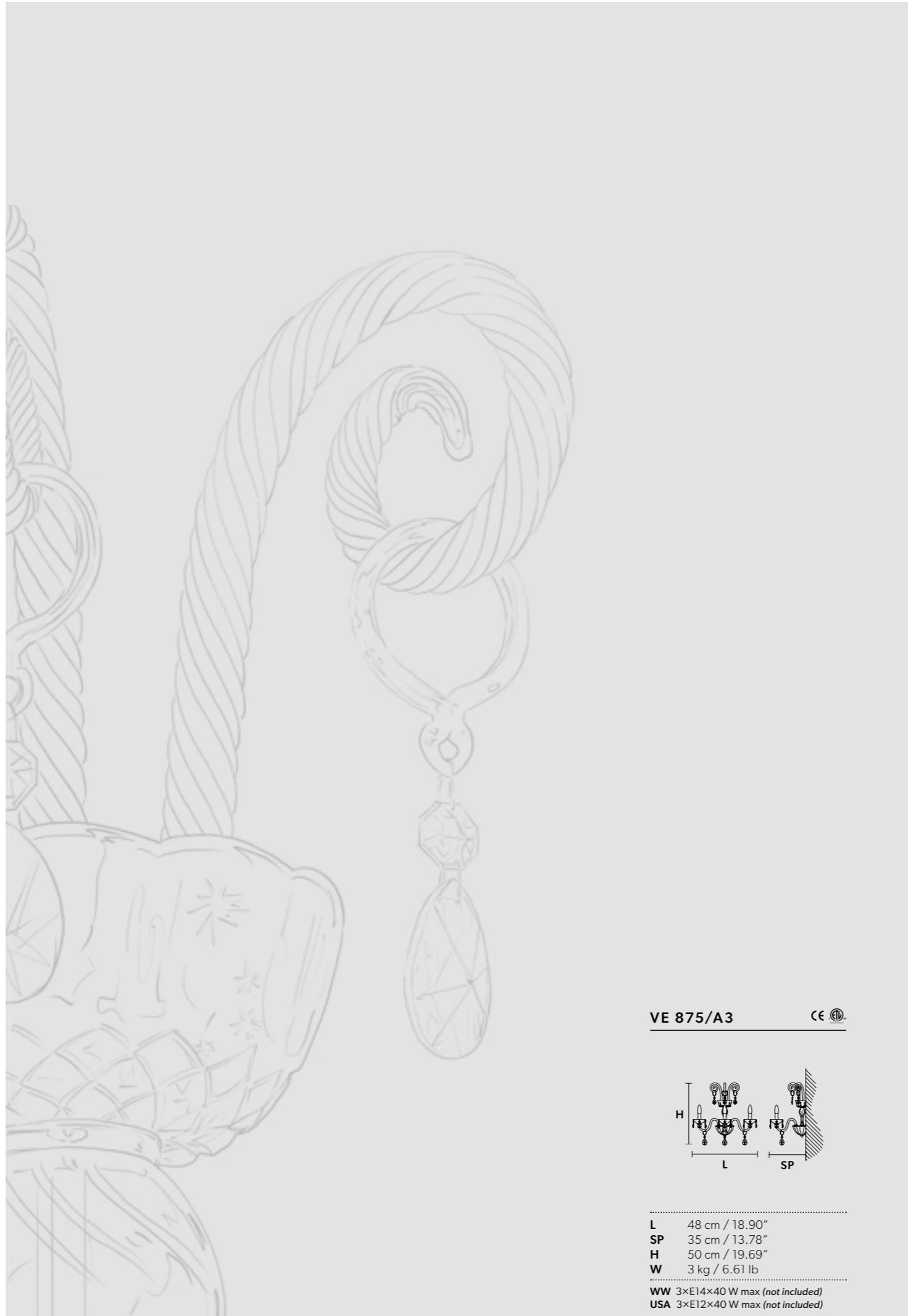
L 35 cm / 13.80"
 SP 22 cm / 8.70"
 H 26 cm / 10.25"
 W 2 kg / 4.41 lb

WW 2×E14×40 W max (not included)
 USA 2×E12×40 W max (not included)

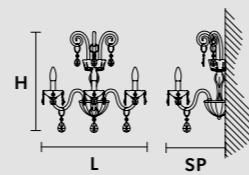


VE 875/12	CE	VE 875/16	CE
			
<p>Ø 120 cm / 47.30"</p> <p>H 120 cm / 47.30"</p> <p>W 25 kg / 55.11 lb</p> <p>WW 12×E14×40 W max (not included)</p> <p>USA 12×E12×40 W max (not included)</p>		<p>Ø 145 cm / 57.09"</p> <p>H 120 cm / 47.30"</p> <p>W 32 kg / 70.54 lb</p> <p>WW 16×E14×40 W max (not included)</p> <p>USA 16×E12×40 W max (not included)</p>	

VE 875/16



VE 875/A3 CE



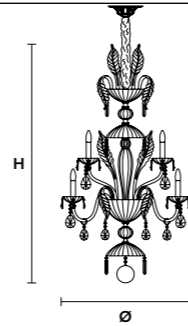
L	48 cm / 18.90"
SP	35 cm / 13.78"
H	50 cm / 19.69"
W	3 kg / 6.61 lb
WW 3×E14×40 W max (not included)	
USA 3×E12×40 W max (not included)	



VE 875/A3



VE 886/12 CE



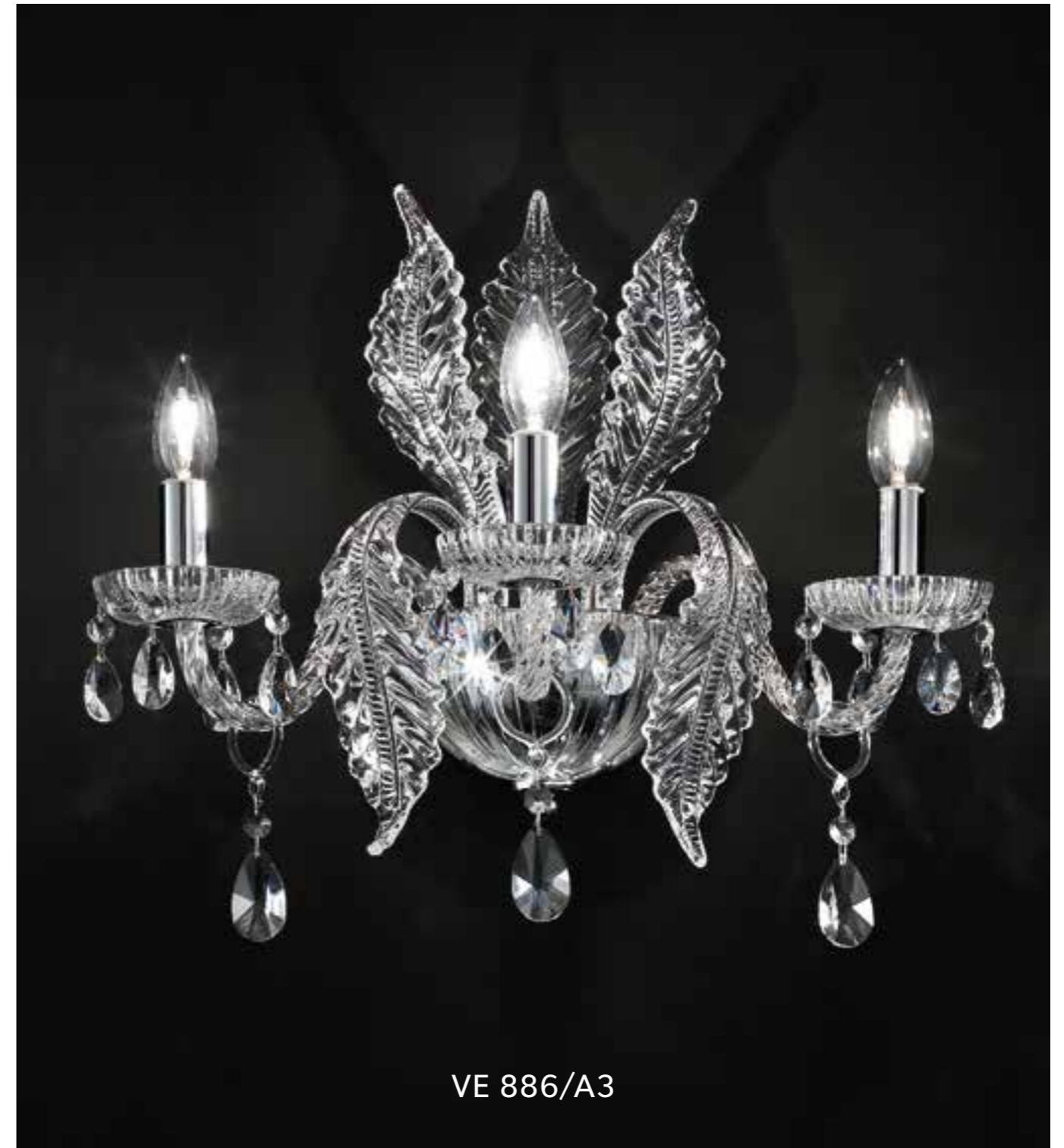
Ø 70 cm / 27.55"
 H 130 cm / 51.20"
 W 27 kg / 59.52 lb

WW 12×E14×40 W max (not included)
 USA 12×E12×40 W max (not included)

VE 886/12



VE 886/A5

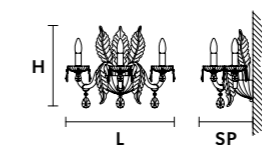
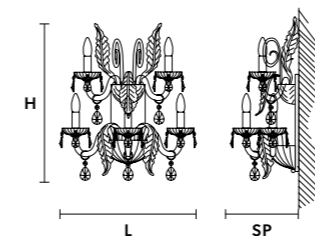


VE 886/A3

VE 886/A5



VE 886/A3



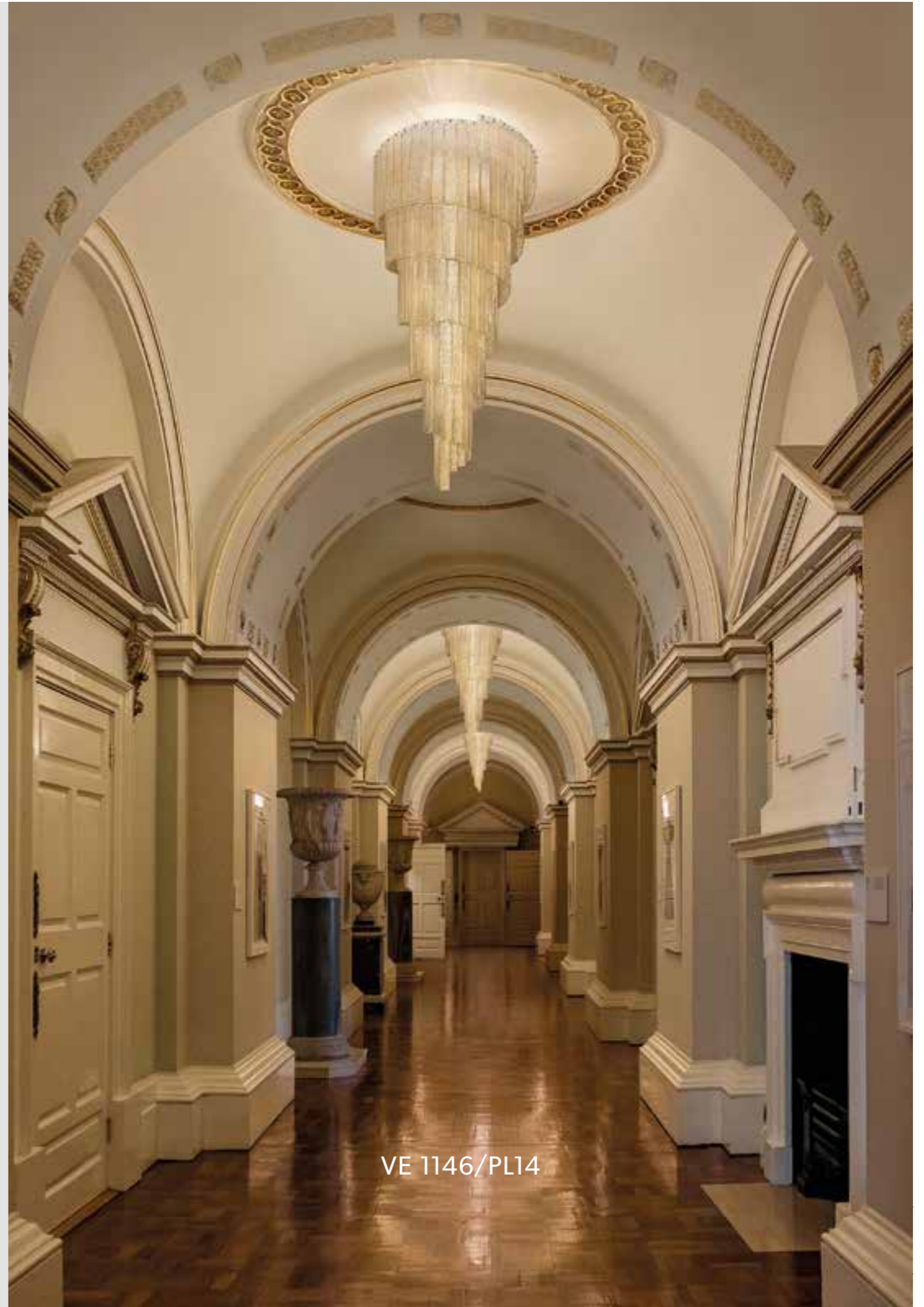
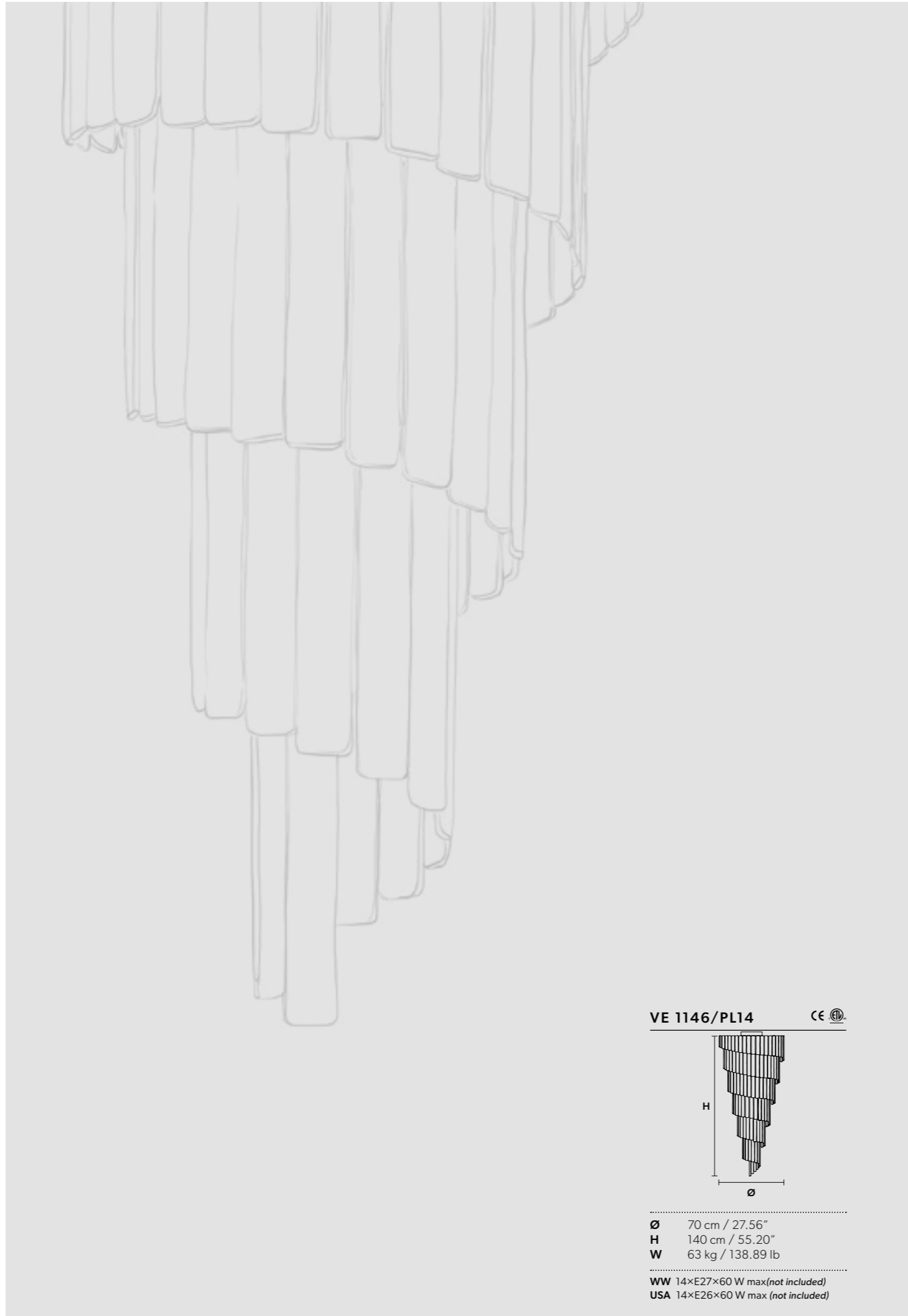
L 50 cm / 19.68"
 SP 30 cm / 11.81"
 H 60 cm / 23.62"
 W 7 kg / 15.43 lb

WW 5×E14×40 W max (not included)
 USA 5×E12×40 W max (not included)

L 48 cm / 18.90"
 SP 28 cm / 11.05"
 H 40 cm / 15.75"
 W 4 kg / 8.81 lb

WW 3×E14×40 W max (not included)
 USA 3×E12×40 W max (not included)



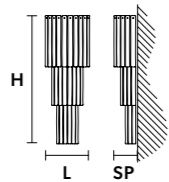
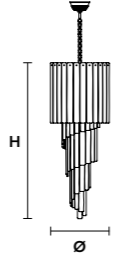
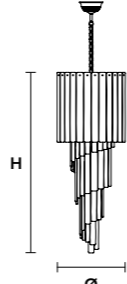


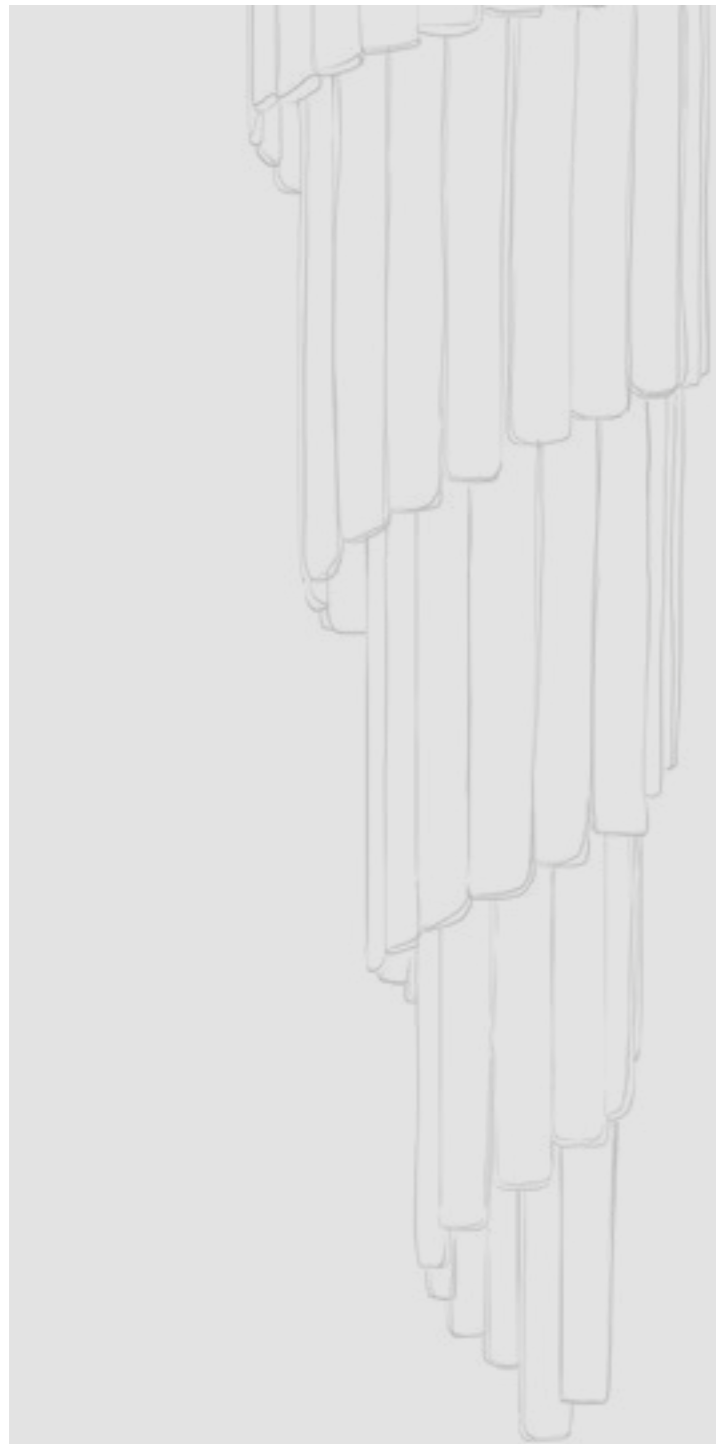


VE 1146/A4



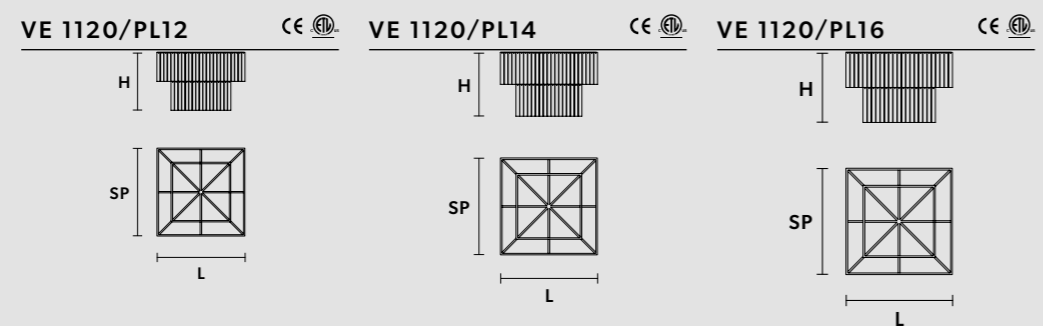
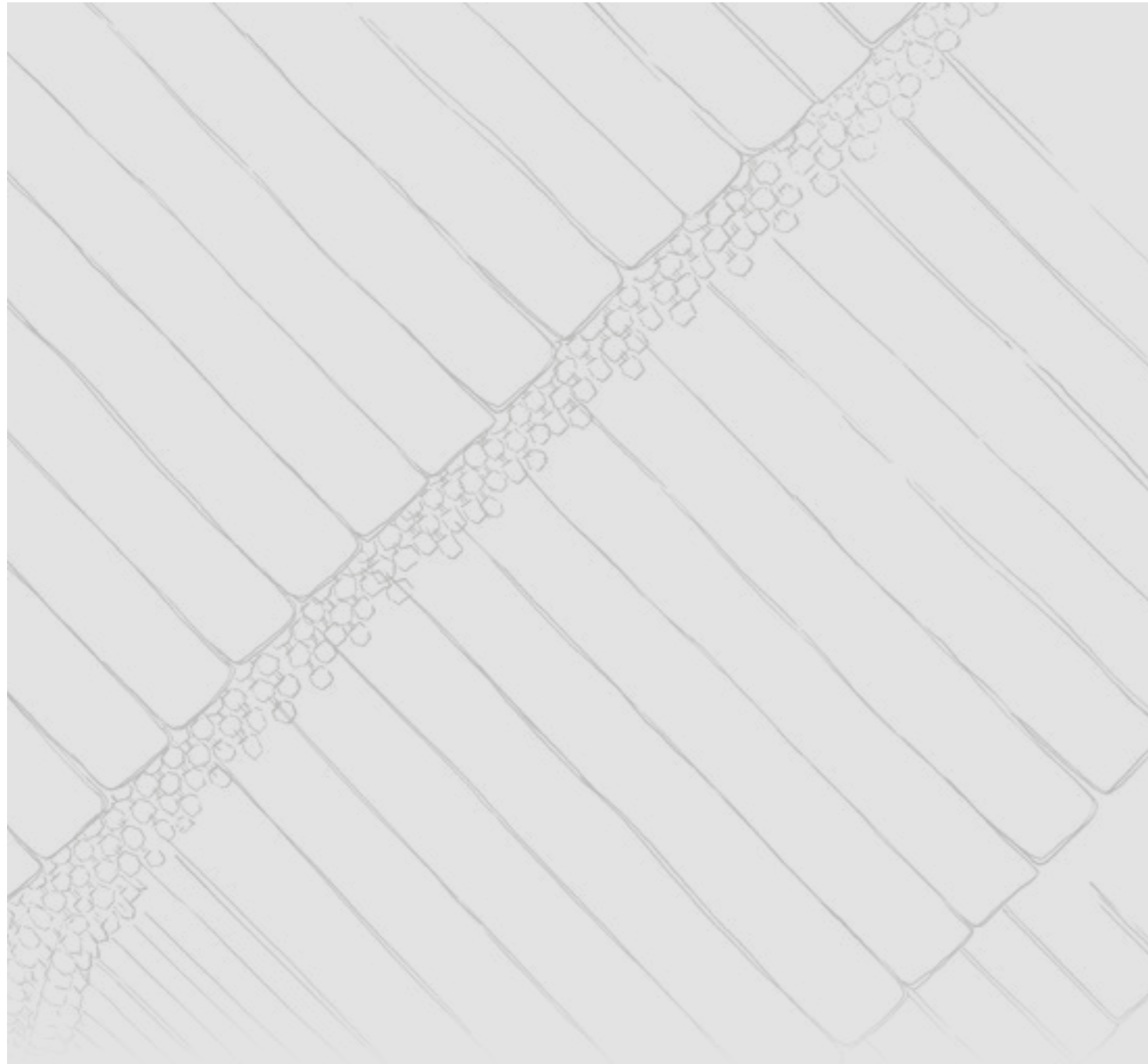
VE 1149/S7

VE 1146/A4	CE	VE 1149/S7	CE	VE 1149/S16	CE
					
L 26 cm / 10.25"		Ø 40 cm / 15.75"		Ø 50 cm / 19.70"	
SP 14 cm / 5.55"		H 90 cm / 35.50"		H 160 cm / 63.00"	
H 70 cm / 27.56"		W 28 kg / 61.72 lb		W 35 kg / 77.16 lb	
W 12 kg / 26.45 lb					
WW 4×E14×40 W max (not included)		WW 7×E14×40 W max (not included)		WW 16×E14×40 W max (not included)	
USA 4×E12×40 W max (not included)		USA 7×E12×40 W max (not included)		USA 16×E12×40 W max (not included)	



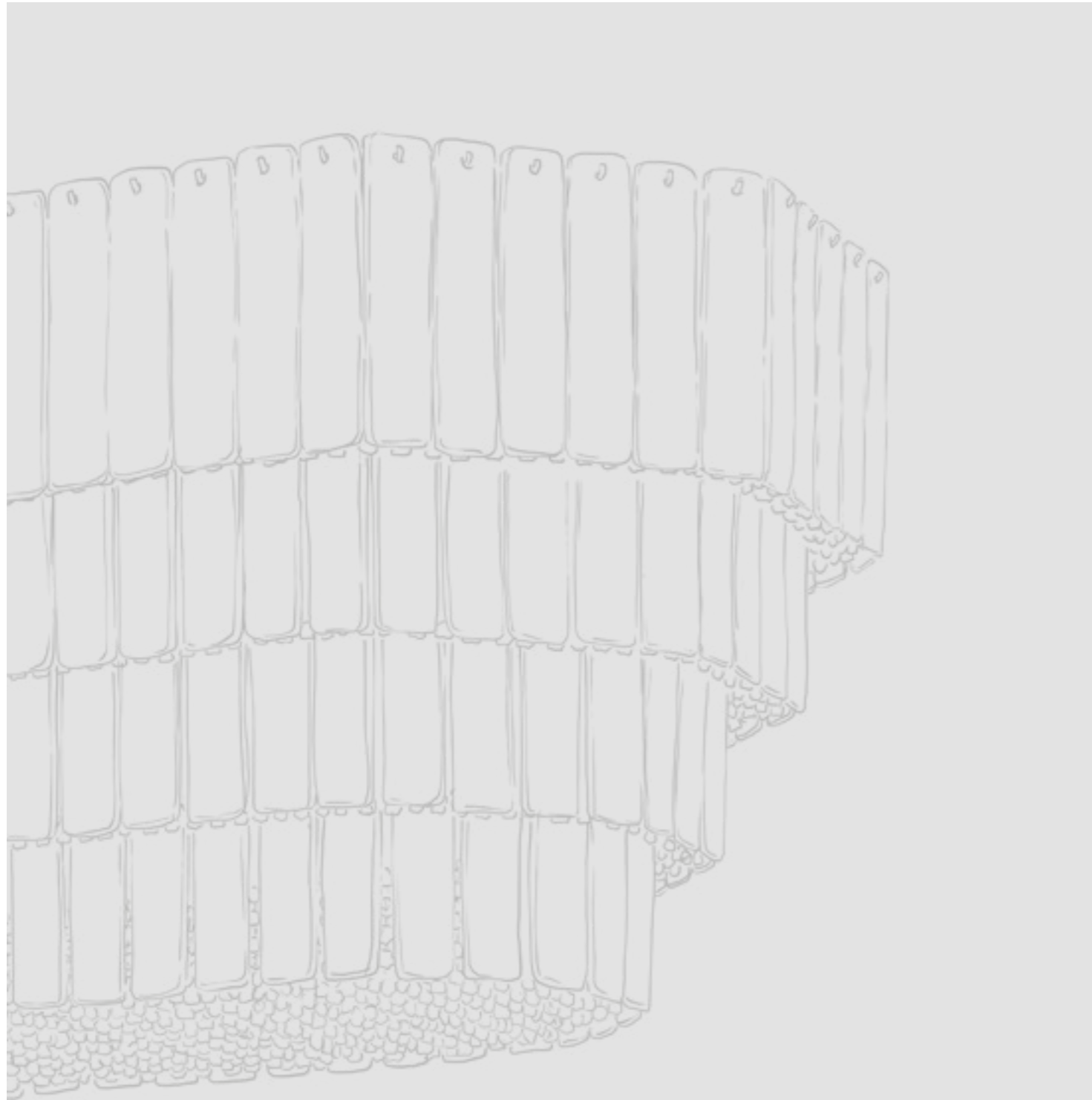
VE 1144/S20	CE	VE 1144/S30	CE	VE 1144/S40	CE	VE 1144/S52	CE
Ø 50 cm / 19.70" H 230 cm / 90.55" W 105 kg / 231 lb		Ø 80 cm / 31.50" H 360 cm / 141.73" W 240 kg / 529.1 lb		Ø 100 cm / 39.40" H 450 cm / 177.20" W 360 kg / 793.6 lb		Ø 120 cm / 47.30" H 500 cm / 196.90" W 580 kg / 1278 lb	
WW 1xE14x40 W max + 19xE27x60 W max (not included) USA 1xE12x40 W max + 19xE26x60 W max (not included)		WW 30xE27x60 W max (not included) USA 30xE26x60 W max (not included)		WW 40xE27x60 W max (not included) USA 40xE26x60 W max (not included)		WW 52xE27x60 W max (not included) USA 52xE26x60 W max (not included)	

VE 1144/S20

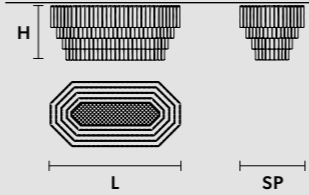


<p>L 80 cm / 31.50"</p> <p>SP 80 cm / 31.50"</p> <p>H 80 cm / 31.50"</p> <p>W 45 kg / 99.20 lb</p> <hr/> <p>WW 12×E27×60 W max (not included)</p> <p>USA 12×E26×60 W max (not included)</p>	<p>L 100 cm / 39.40"</p> <p>SP 100 cm / 39.40"</p> <p>H 80 cm / 31.50"</p> <p>W 55 kg / 121.25 lb</p> <hr/> <p>WW 14×E27×60 W max (not included)</p> <p>USA 14×E26×60 W max (not included)</p>	<p>L 120 cm / 47.30"</p> <p>SP 120 cm / 47.30"</p> <p>H 80 cm / 31.50"</p> <p>W 71 kg / 156.52 lb</p> <hr/> <p>WW 16×E27×60 W max (not included)</p> <p>USA 16×E26×60 W max (not included)</p>
---	--	--

VE 1120/PL16



VE 1147/PL16 CE



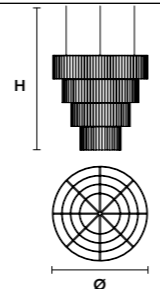
.....
L 120 cm / 47.30"
SP 60 cm / 23.70"
H 50 cm / 19.70"
W 80 kg / 176.36 lb

WW 16×E14×40 W max (not included)
USA 16×E12×40 W max (not included)

VE 1147/PL16

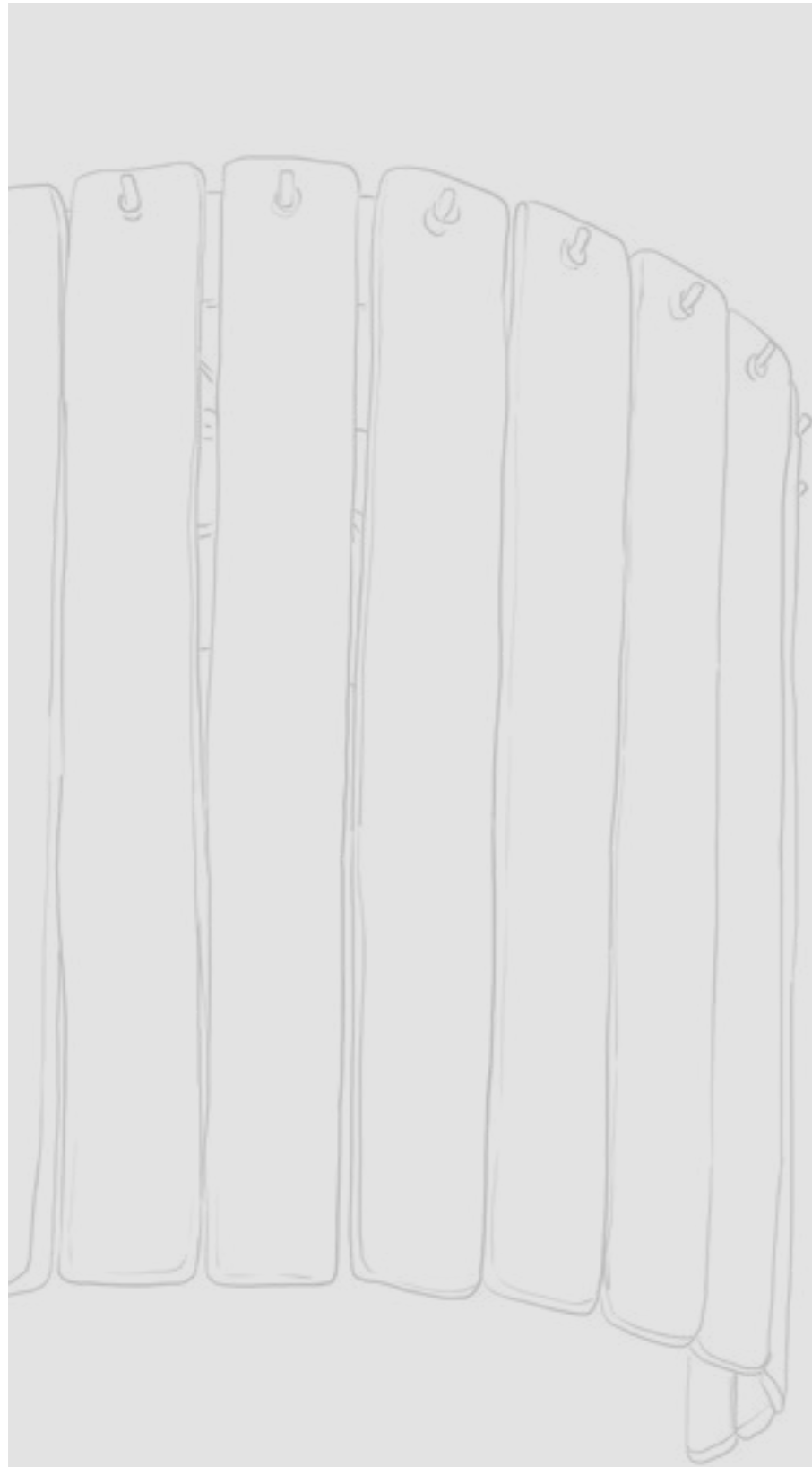


VE 1120/28 CE

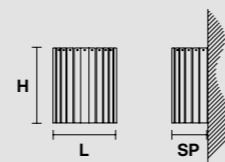


- Ø 170 cm / 67.00"
- H 150 cm / 59.10"
- W 263 kg / 579.8 lb
- WW 28×E27×60 W max (not included)
- USA 28×E26×60 W max (not included)

VE 1120/28



VE 1120/A2 

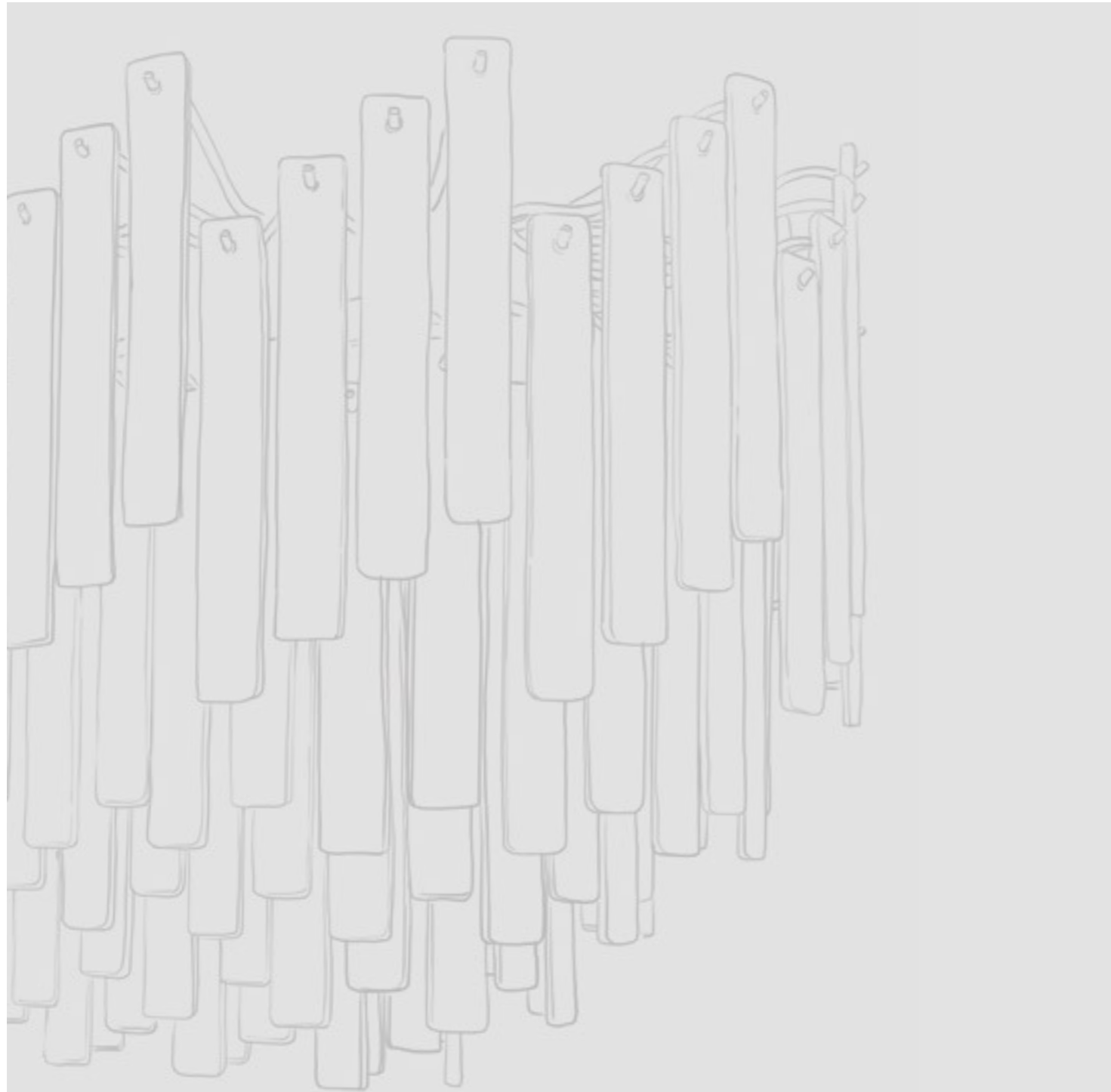


.....
L 38 cm / 15.00"
SP 20 cm / 7.90"
H 40 cm / 15.75"
W 8 kg / 17.63 lb

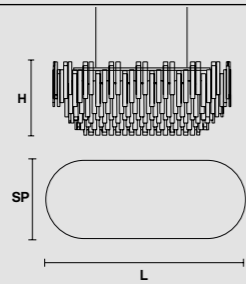
WW 2xE27x60 W max (not included)
USA 2xE26x60 W max (not included)




VE 1120/A2

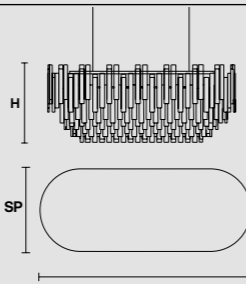


VE 1145/S8 OV 




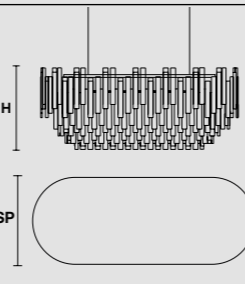
L 85 cm / 33.46"
 SP 52 cm / 20.50"
 H 50 cm / 19.70"
 W 50 kg / 110.23 lb
 WW 8x E27x60 W max (not included)
 USA 8x E26x60 W max (not included)

VE 1145/S14 OV 



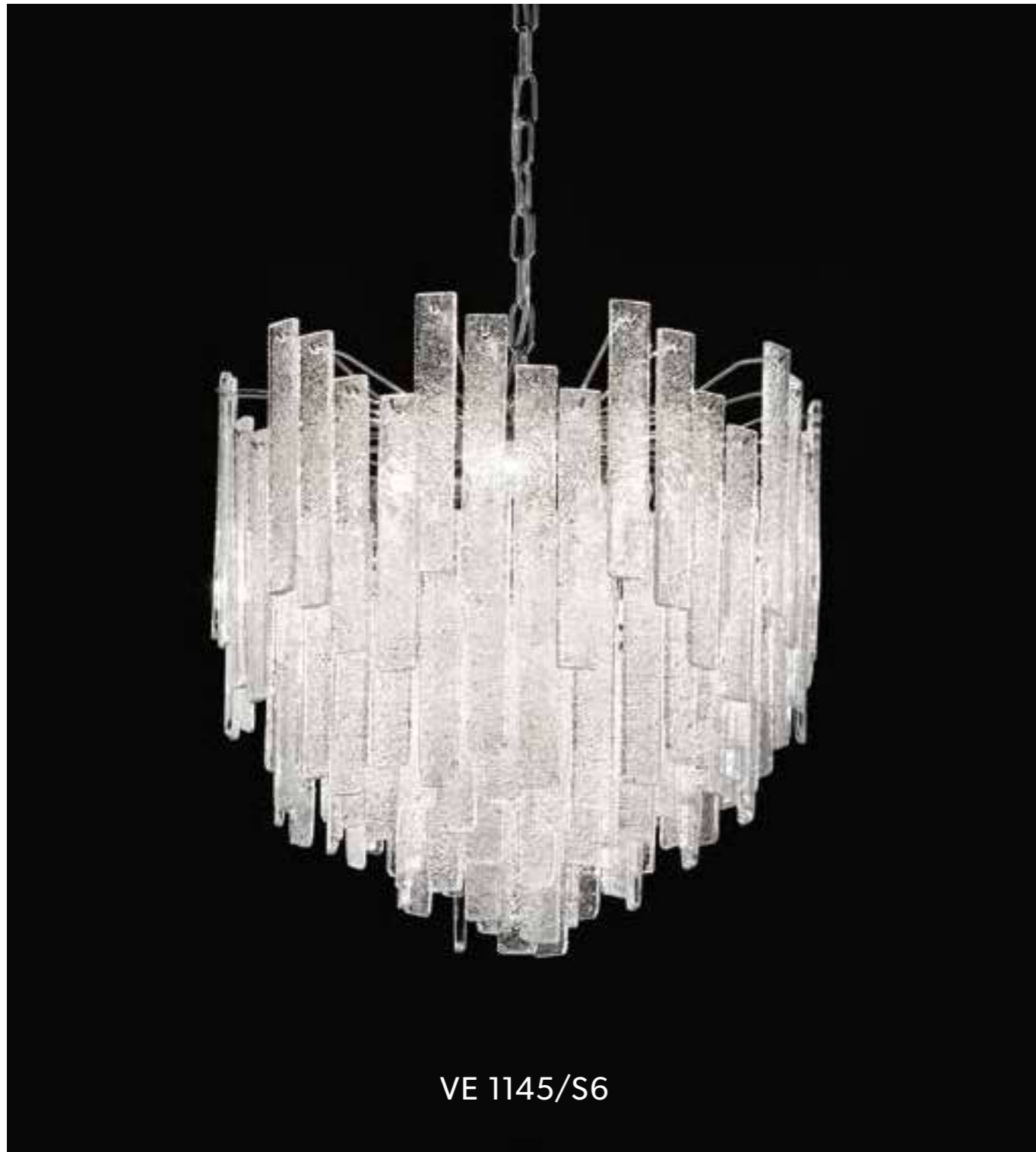
L 120 cm / 47.24"
 SP 52 cm / 20.50"
 H 50 cm / 19.70"
 W 68 kg / 149.91 lb
 WW 14x E27x60 W max (not included)
 USA 14x E26x60 W max (not included)

VE 1145/S20 OV 



L 155 cm / 61.00"
 SP 52 cm / 20.50"
 H 50 cm / 19.70"
 W 95 kg / 209.44 lb
 WW 20x E27x60 W max (not included)
 USA 20x E26x60 W max (not included)

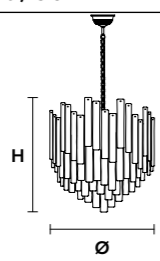
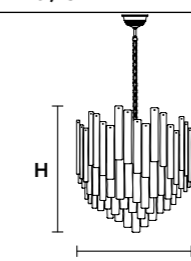
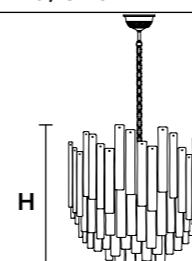
VE 1145/S14 OV




VE 1145/S6

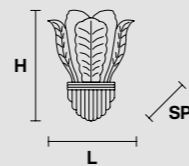


VE 1145/S14

VE 1145/S6	VE 1145/S14	VE 1145/S20
		
<p>Ø 52 cm / 20.47"</p> <p>H 50 cm / 19.69"</p> <p>W 29 kg / 63.93 lb</p>	<p>Ø 80 cm / 31.50"</p> <p>H 75 cm / 29.53"</p> <p>W 65 kg / 143.3 lb</p>	<p>Ø 100 cm / 39.37"</p> <p>H 110 cm / 43.31"</p> <p>W 100 kg / 220.4 lb</p>
<p>WW 6×E27×60 W max (not included)</p> <p>USA 6×E26×60 W max (not included)</p>	<p>WW 14×E27×60 W max (not included)</p> <p>USA 14×E26×60 W max (not included)</p>	<p>WW 20×E27×60 W max (not included)</p> <p>USA 20×E26×60 W max (not included)</p>



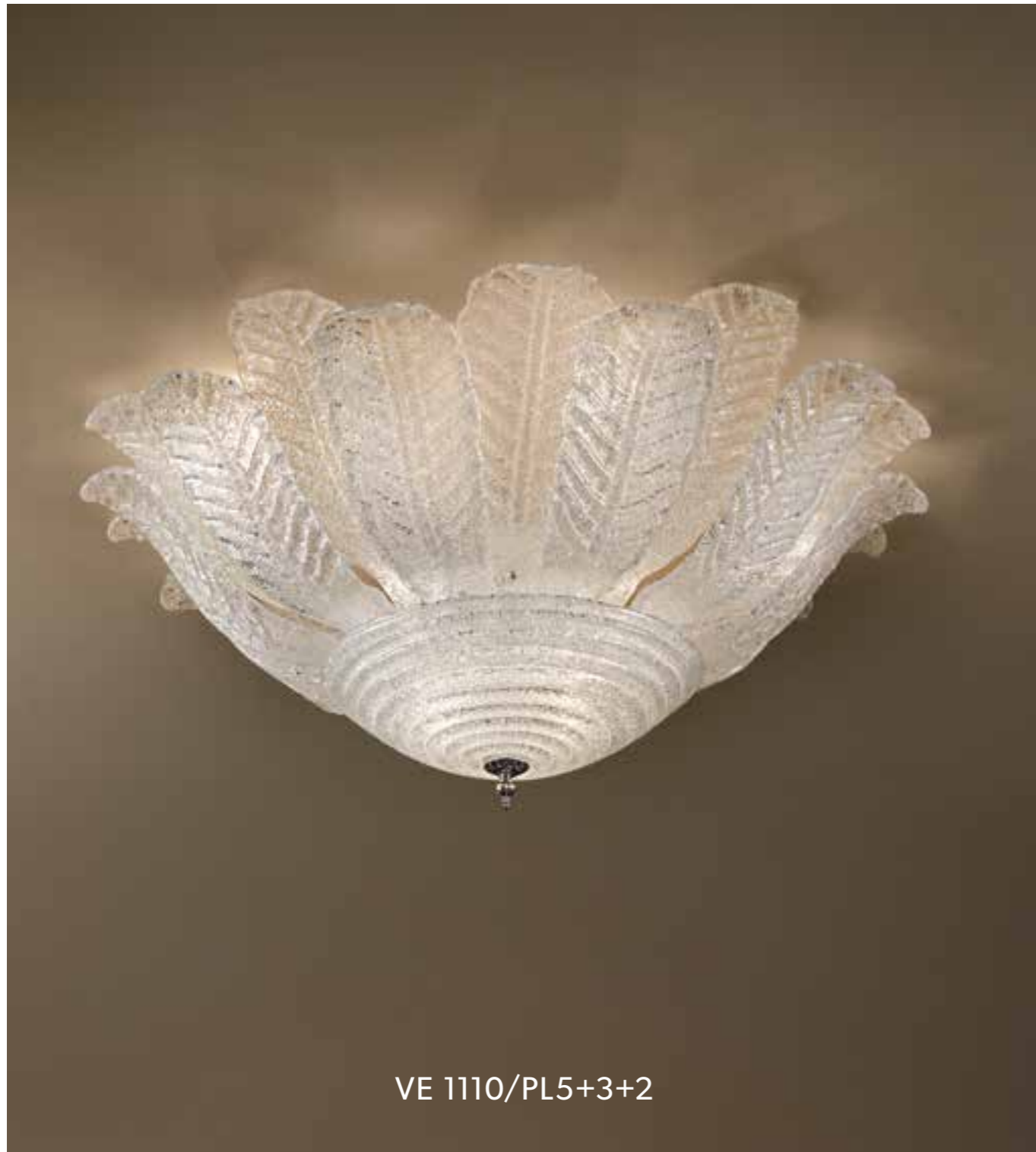
VE 1110/A1+1 



L	45 cm / 17.72"
SP	23 cm / 9.06"
H	60 cm / 23.62"
W	12.5 kg / 27.55 lb
<hr/>	
WW	1×E27×60 W max + 1×E14×40 W max (not included)
USA	1×E26×60 W max + 1×E12×40 W max (not included)



VE 1110/A1+1



VE 1110/PL5+3+2

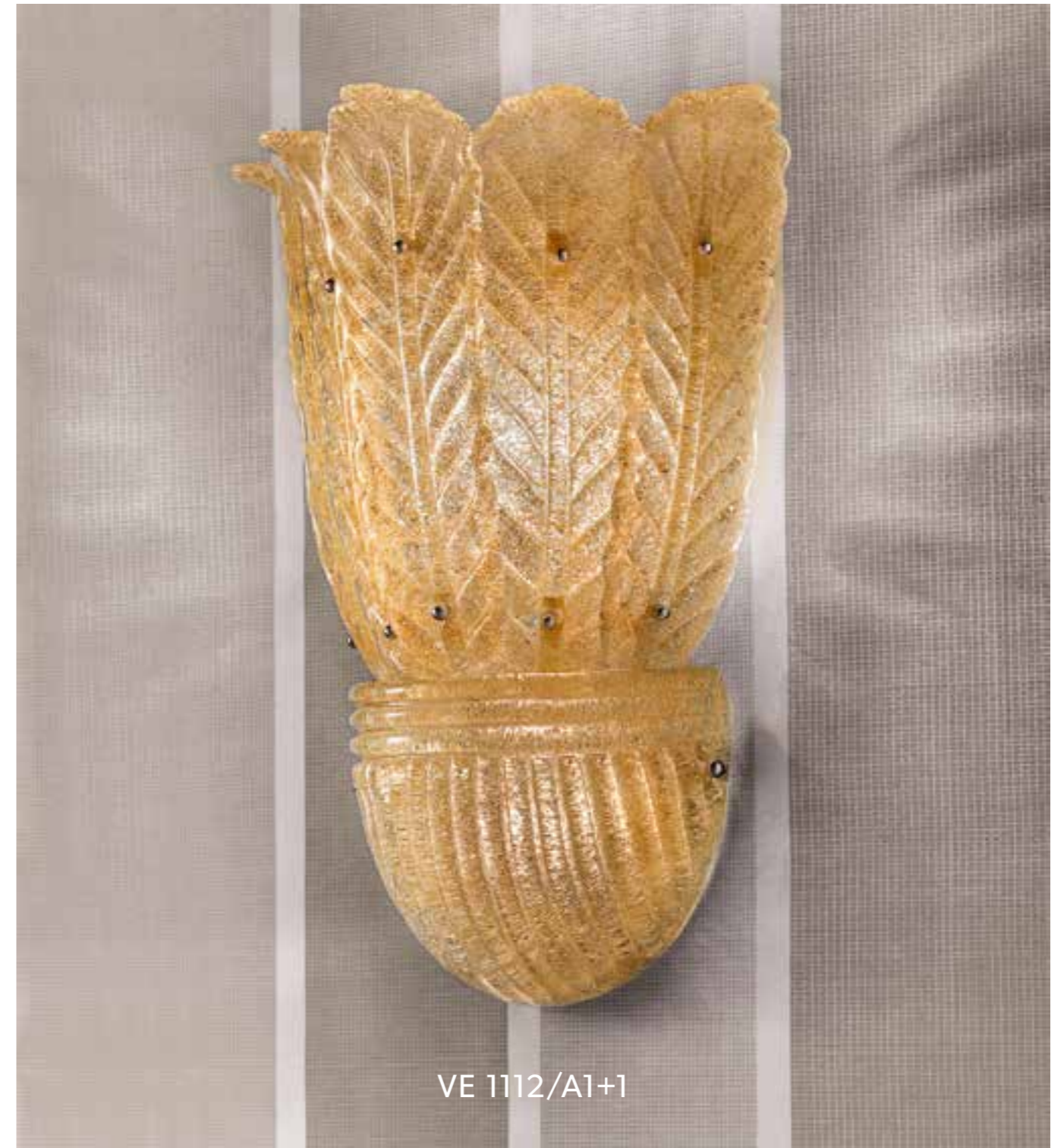
VE 1110/PL5+3+2	CE	VE 1110/PL12+2	CE
<p>Ø 100 cm / 39.37"</p> <p>H 60 cm / 23.62"</p> <p>W 33 kg / 72.75 lb</p>		<p>Ø 140 cm / 55.12"</p> <p>H 85 cm / 33.46"</p> <p>W 47 kg / 103.61 lb</p>	
<p>WW 10×E27×60 W max (not included)</p> <p>USA 10×E26×60 W max (not included)</p>		<p>WW 14×E27×60 W max (not included)</p> <p>USA 14×E26×60 W max (not included)</p>	




VE 1110/PL12+2

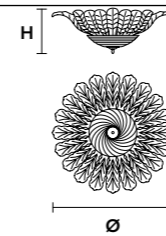



VE 1112/PL6+3+3

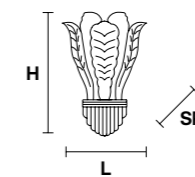


VE 1112/A1+1

VE 1112/PL6+3+3 



VE 1112/A1+1 



Ø 110 cm / 43.30"
 H 70 cm / 27.56"
 W 40 kg / 88.18 lb

L 40 cm / 21.65"
 SP 20 cm / 7.87"
 H 55 cm / 21.65"
 W 12.5 kg / 27.55 lb

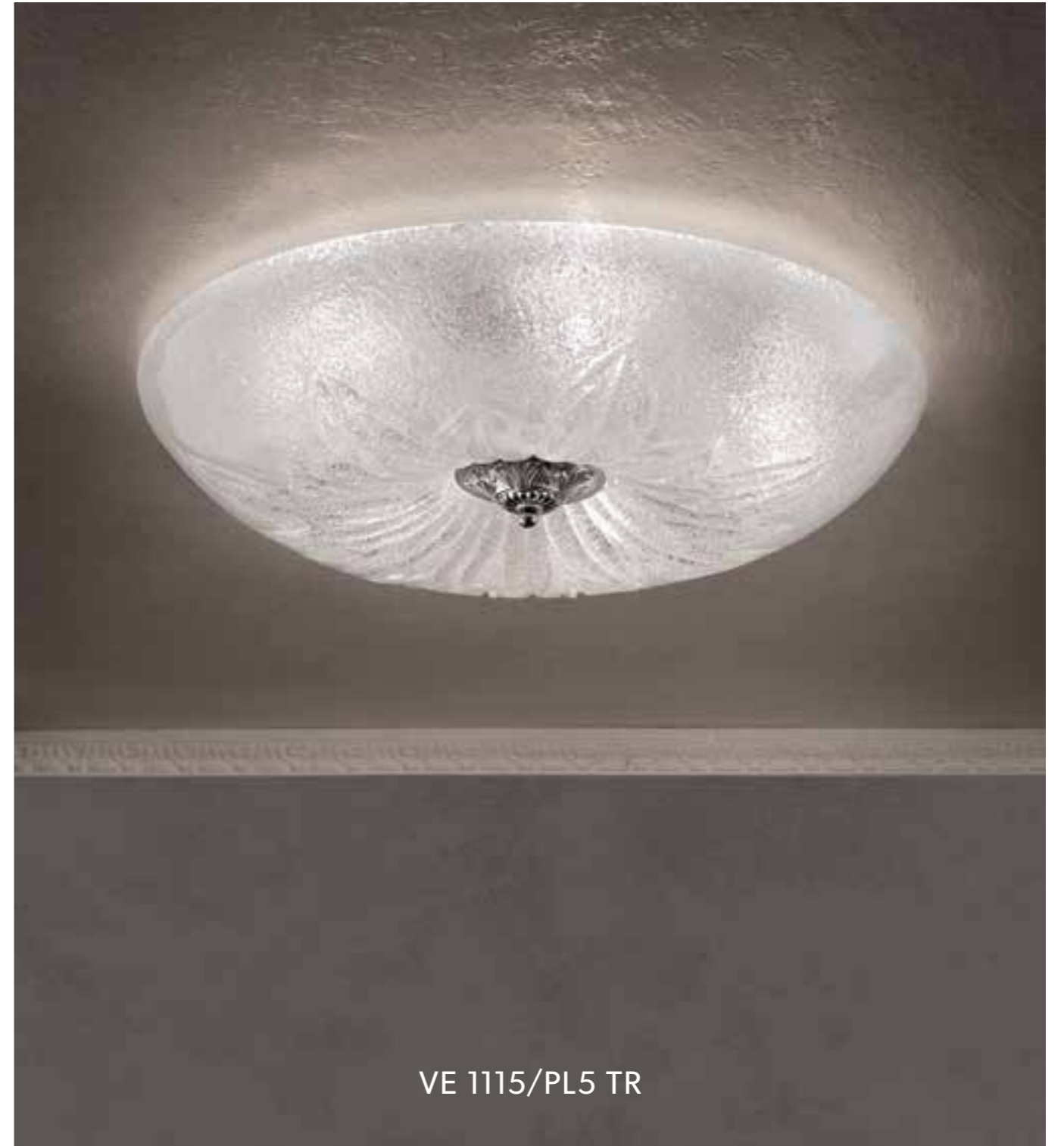
WW 12×E27×60 W max (not included)
 USA 12×E26×60 W max (not included)

WW 1×E27×60 W max +
 1×E14×40 W max (not included)
 USA 1×E26×60 W max +
 1×E12×40 W max (not included)

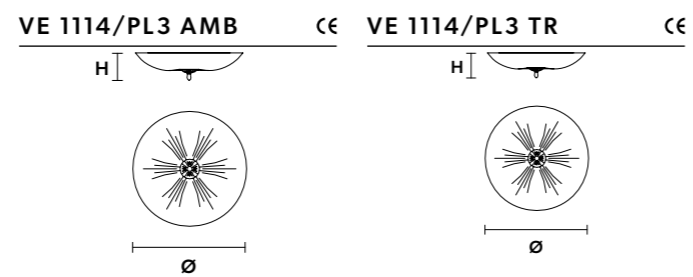


VE 1114/PL3 AMB

VE 1115/PL5 AMB



VE 1115/PL5 TR

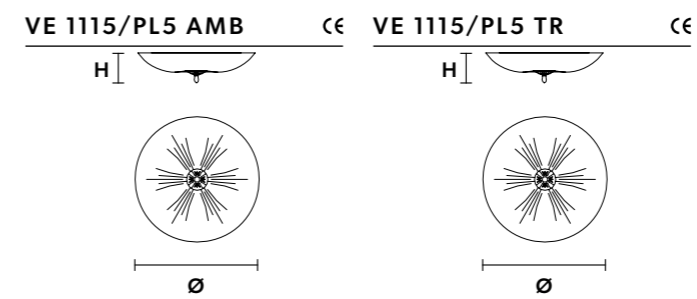


Ø 45 cm / 17.80"
H 12 cm / 4.80"
W 8.5 kg / 18.73 lb

WW 3×E27×60 W max (not included)
USA 3×E26×60 W max (not included)

Ø 45 cm / 17.80"
H 12 cm / 4.80"
W 8.5 kg / 18.73 lb

WW 3×E27×60 W max (not included)
USA 3×E26×60 W max (not included)



Ø 65 cm / 25.60"
H 15 cm / 6.00"
W 14 kg / 30.86 lb

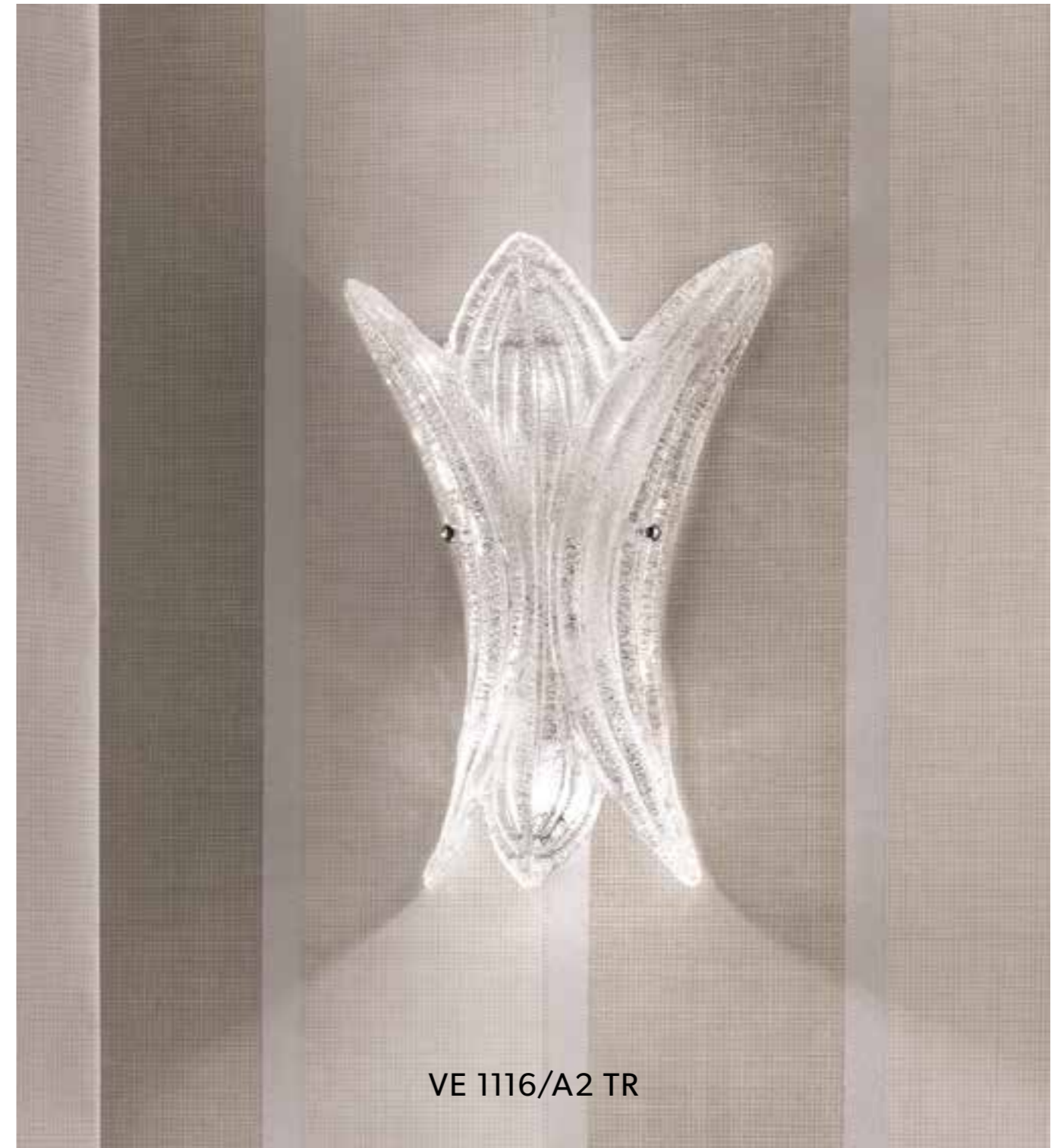
WW 5×E27×60 W max (not included)
USA 5×E26×60 W max (not included)

Ø 65 cm / 25.60"
H 15 cm / 6.00"
W 14 kg / 30.86 lb

WW 5×E27×60 W max (not included)
USA 5×E26×60 W max (not included)



VE 1116/A2 AMB

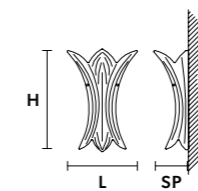
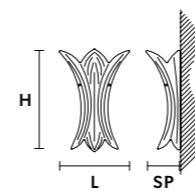


VE 1116/A2 TR

VE 1116/A2 AMB



VE 1116/A2 TR

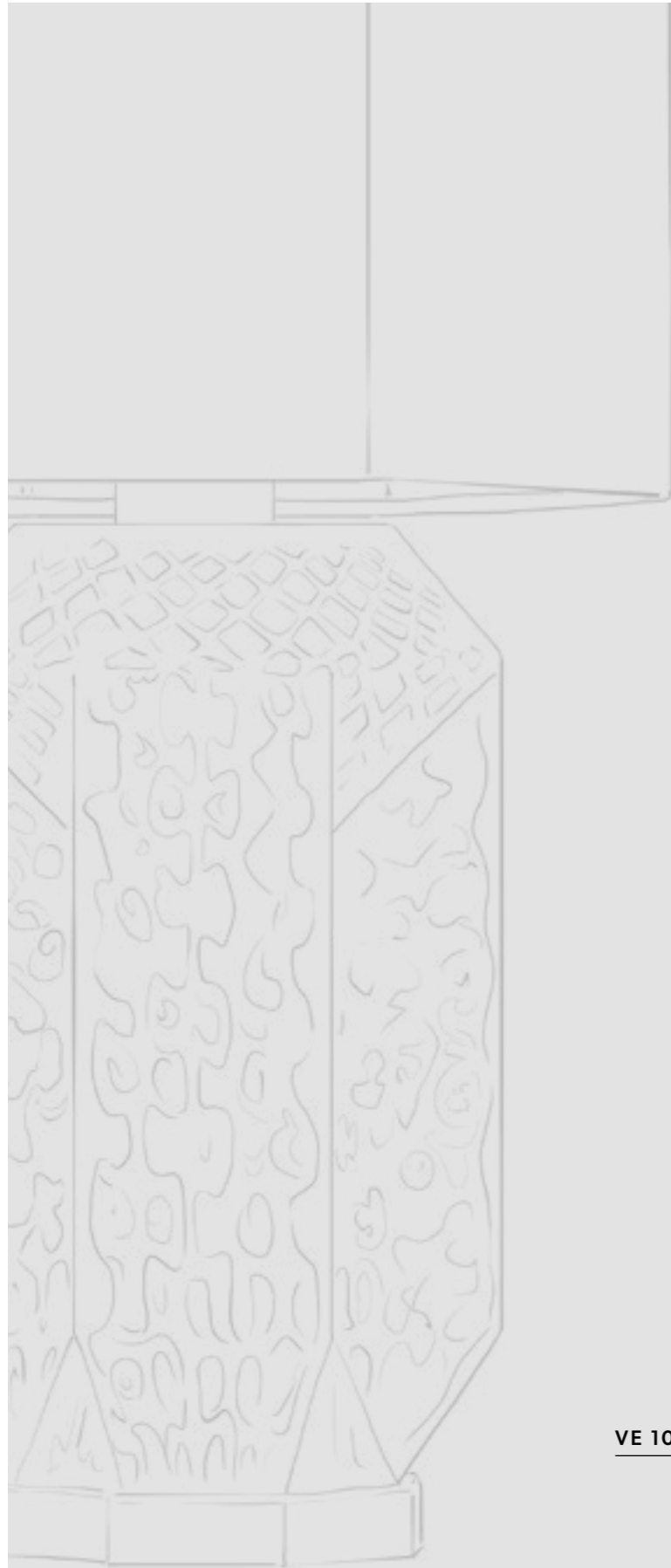


L 28 cm / 11.10"
 SP 15 cm / 6.00"
 H 38 cm / 15.00"
 W 3 kg / 6.61 lb

L 28 cm / 11.10"
 SP 15 cm / 6.00"
 H 38 cm / 15.00"
 W 3 kg / 6.61 lb

WW 2xE14x40 W max (not included)
 USA 2xE12x40 W max (not included)

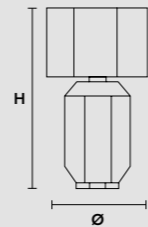
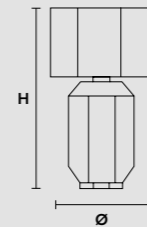
WW 2xE14x40 W max (not included)
 USA 2xE12x40 W max (not included)



VE 1057/TL1



VE 1058/TL1



Ø 29 cm / 11.40"
H 49 cm / 19.30"
W 3 kg / 6.61 lb

WW 1×E27×60 W max (not included)
USA 1×E26×60 W max (not included)

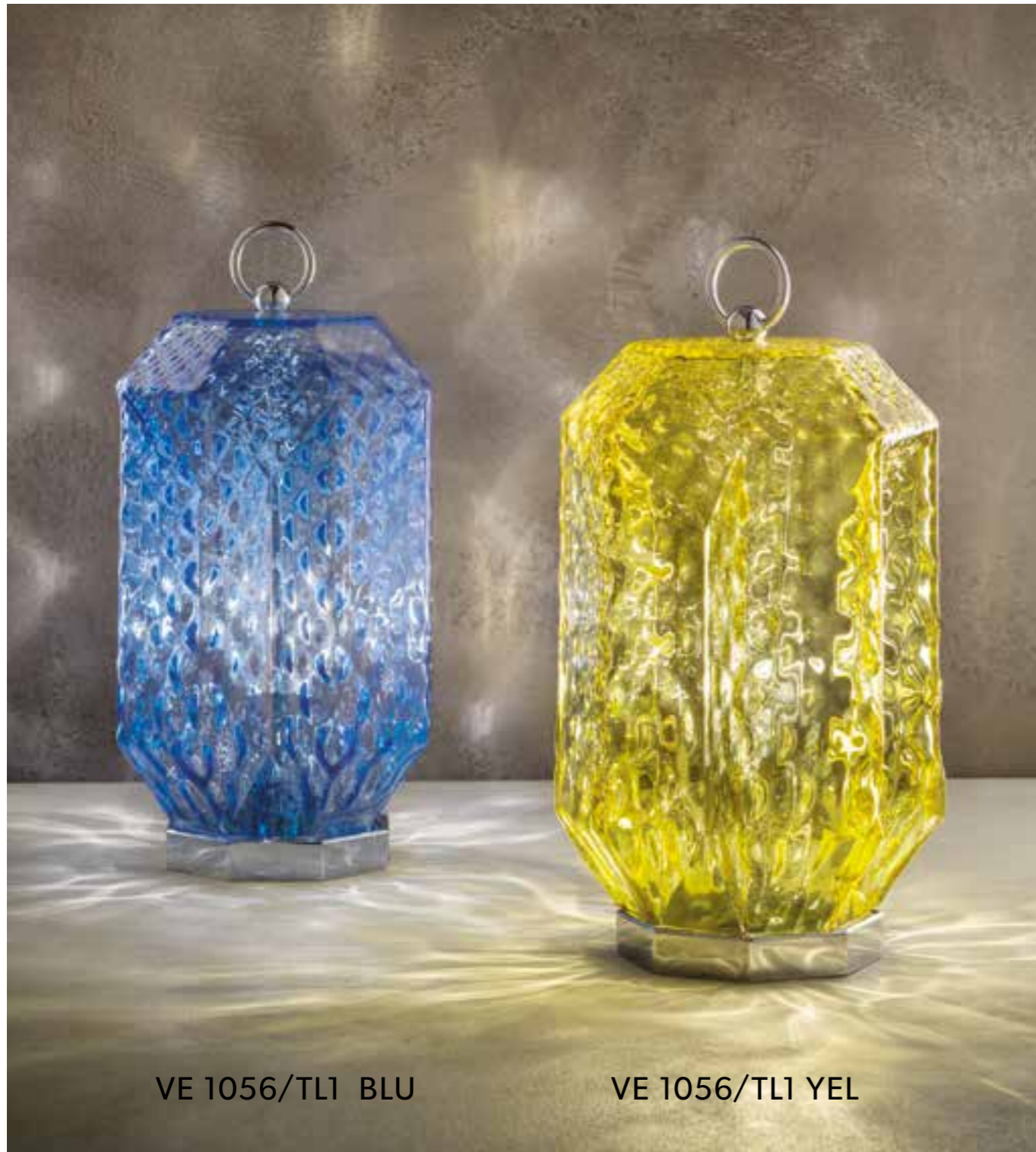
Ø 29 cm / 11.40"
H 49 cm / 19.30"
W 3 kg / 6.61 lb

WW 1×E27×60 W max (not included)
USA 1×E26×60 W max (not included)



VE 1057/TL1

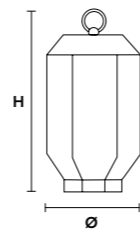
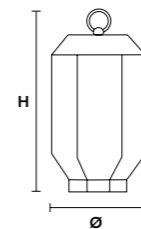
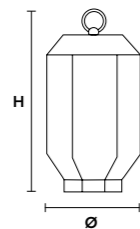
VE 1058/TL1



VE 1056/TL1 BLU

VE 1056/TL1 YEL

VE 1056/TL1 BLU   VE 1056/TL1 YEL   VE 1055/TL1  



Ø 18 cm / 7.00"
H 35 cm / 13.80"

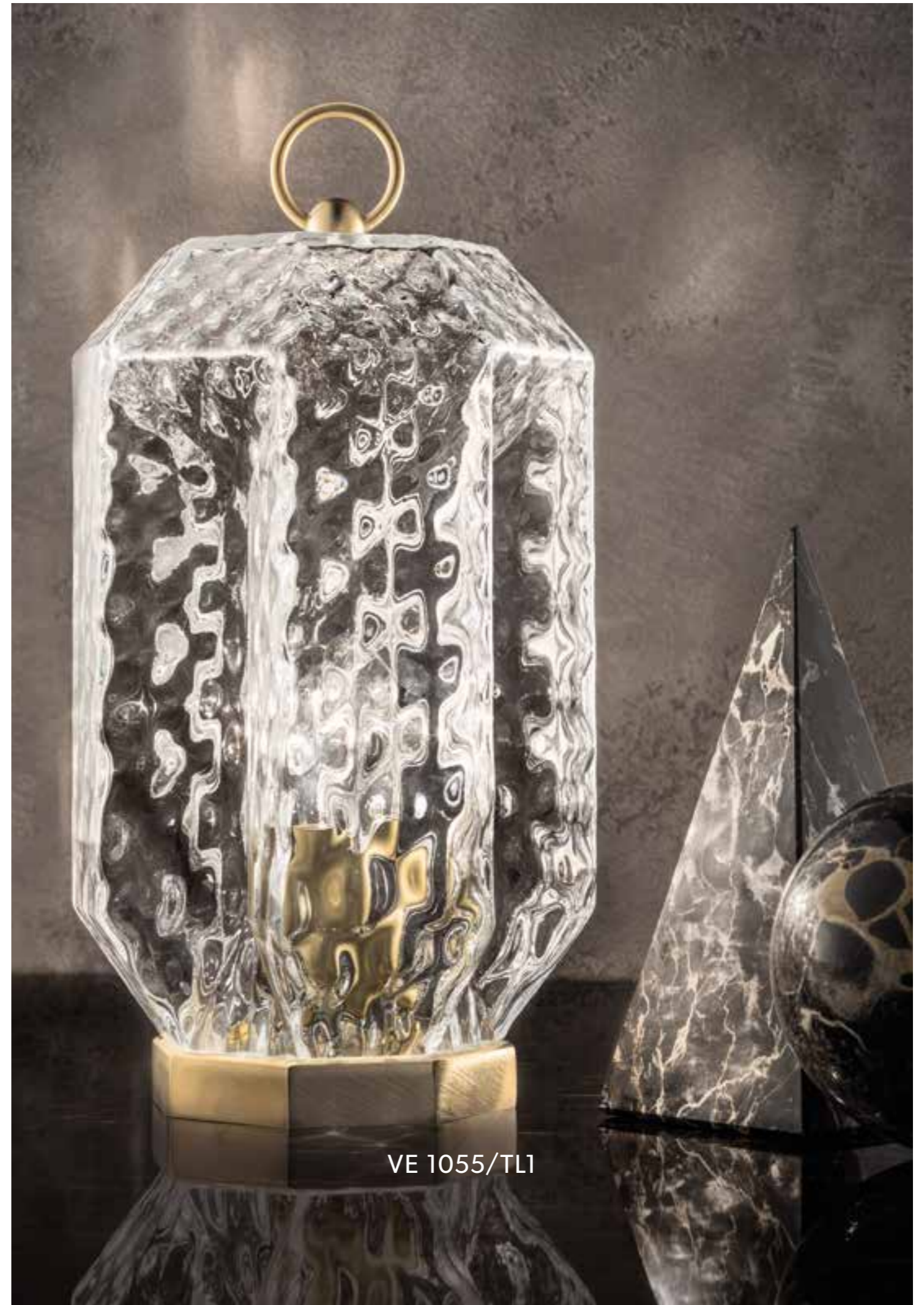
Ø 18 cm / 7.00"
H 35 cm / 13.80"

Ø 18 cm / 7.00"
H 35 cm / 13.80"

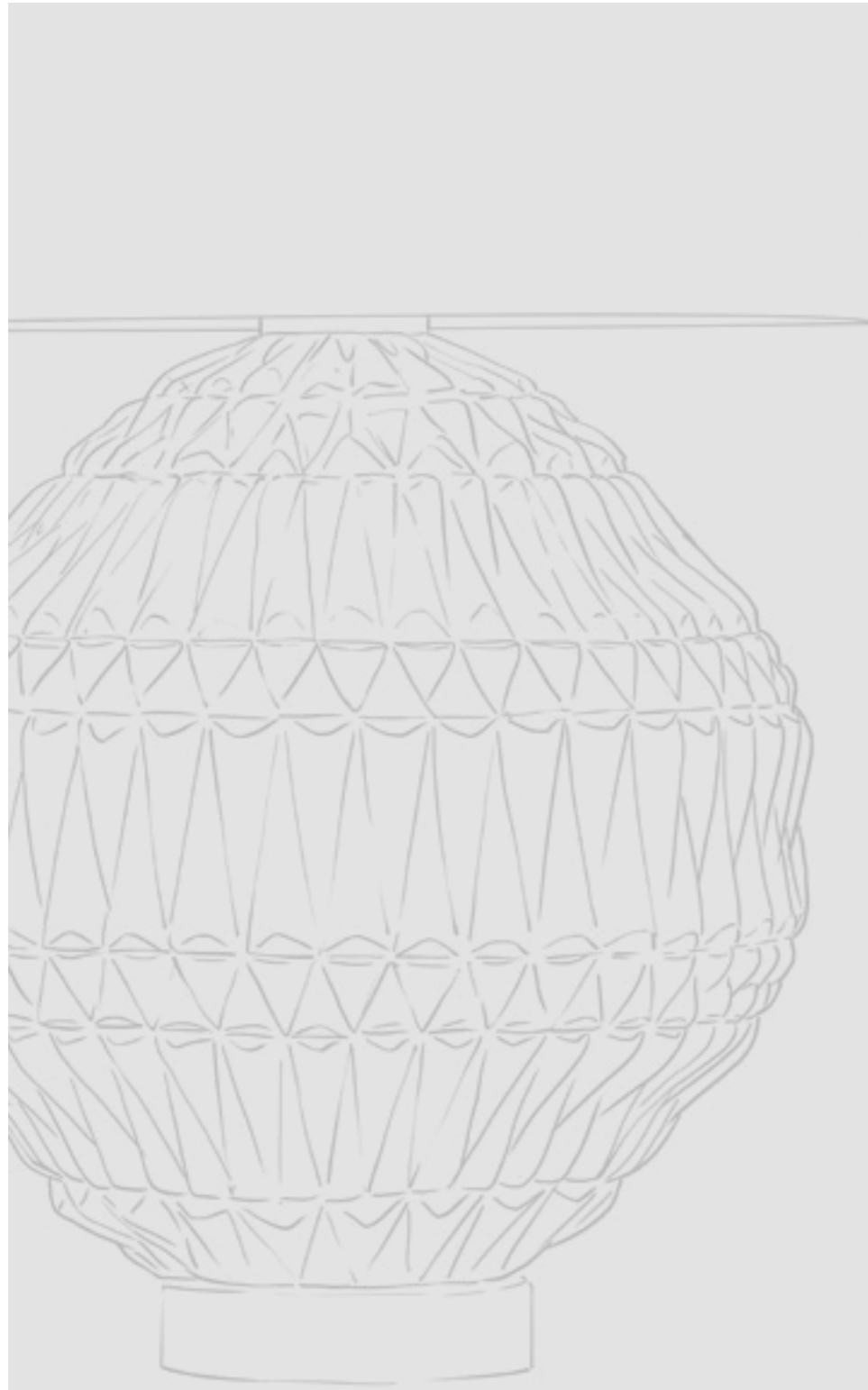
WW 1×E14×40 W max (not included)
USA 1×E12×40 W max (not included)

WW 1×E14×40 W max (not included)
USA 1×E12×40 W max (not included)

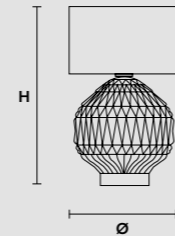
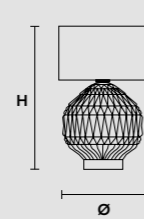
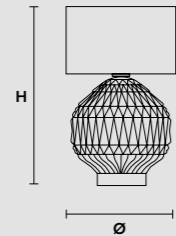
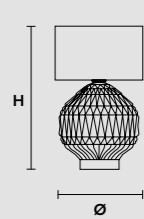
WW 1×E14×40 W max (not included)
USA 1×E12×40 W max (not included)



VE 1055/TL1



VE 1052/TL1 P  VE 1052/TL1 G  VE 1053/TL1 P  VE 1053/TL1 G 



Ø 25 cm / 9.80"
 H 38 cm / 15.00"
 W 1.6 kg / 3.53 lb
 WW 1×E14×40 W max (not included)
 USA 1×E12×40 W max (not included)

Ø 32 cm / 12.59"
 H 50 cm / 19.68"
 W 2.6 kg / 5.73 lb
 WW 1×E27×60 W max (not included)
 USA 1×E26×60 W max (not included)

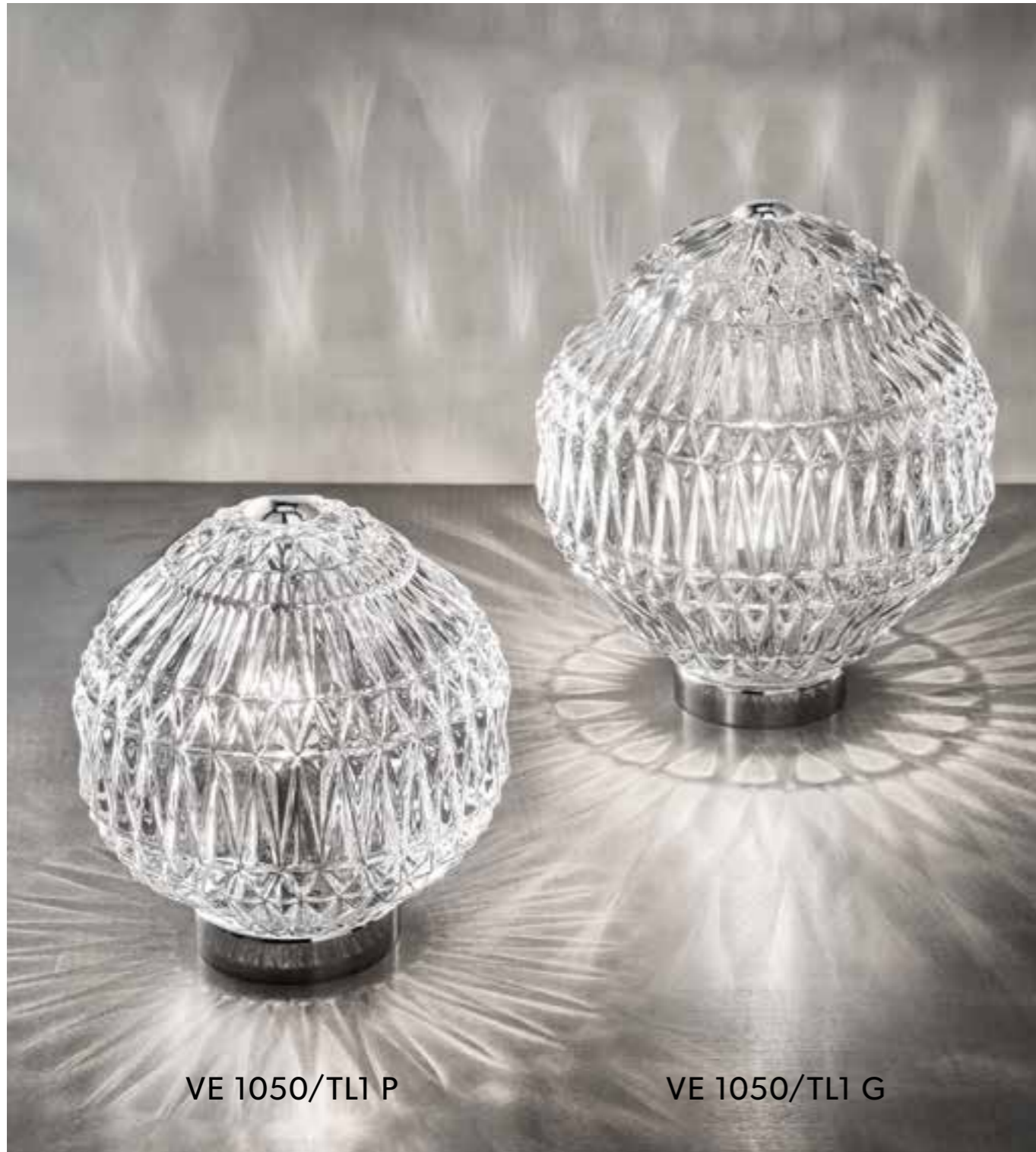
Ø 25 cm / 9.80"
 H 38 cm / 15.00"
 W 1.6 kg / 3.53 lb
 WW 1×E14×40 W max (not included)
 USA 1×E12×40 W max (not included)

Ø 32 cm / 12.59"
 H 50 cm / 19.68"
 W 2.6 kg / 5.73 lb
 WW 1×E27×60 W max (not included)
 USA 1×E26×60 W max (not included)



VE 1052/TL1 G

VE 1053/TL1 P



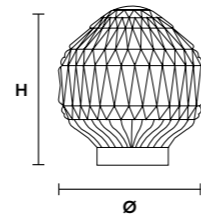
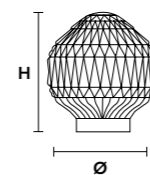
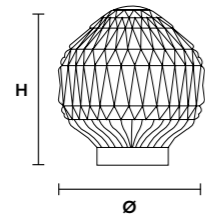
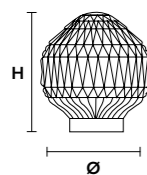
VE 1050/TL1 P

VE 1050/TL1 G



VE 1051/TL1 P

VE 1050/TL1 P VE 1050/TL1 G VE 1051/TL1 P VE 1051/TL1 G



Ø 20 cm / 7.90"
H 22 cm / 8.70"
W 1.8 kg / 3.97 lb

Ø 30 cm / 11.90"
H 26 cm / 10.25"
W 2 kg / 4.40 lb

Ø 20 cm / 7.90"
H 22 cm / 8.70"
W 1.8 kg / 3.97 lb

Ø 30 cm / 11.90"
H 26 cm / 10.25"
W 2 kg / 4.40 lb

WW 1×E14×40 W max(not included)
USA 1×E12×40 W max(not included)

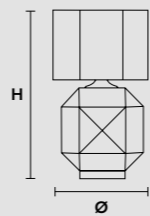
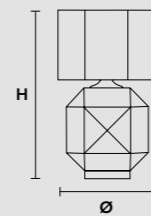
WW 1×E14×40 W max(not included)
USA 1×E12×40 W max(not included)

WW 1×E14×40 W max(not included)
USA 1×E12×40 W max(not included)

WW 1×E14×40 W max(not included)
USA 1×E12×40 W max(not included)



VE 1054/TL1 MOK   **VE 1054/TL1 TRS**  



Ø 23 cm / 9.00"	Ø 23 cm / 9.00"
H 37 cm / 14.60"	H 37 cm / 14.60"
W 2.6 kg / 5.73 lb	W 2.6 kg / 5.73 lb
WW 1×E27×60 W max (not included)	WW 1×E27×60 W max (not included)
USA 1×E26×60 W max (not included)	USA 1×E26×60 W max (not included)

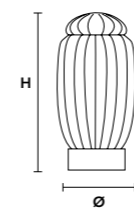


VE 1054/TL1 MOK

VE 1054/TL1 TRS

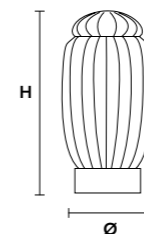


VE 1049/TL1 P G14 VE 1049/TL1 G G14 VE 1049/TL1 P G04 VE 1049/TL1 G G04



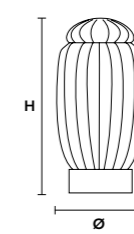
Ø 11 cm / 4.30"
H 23 cm / 9.00"
W 1 kg / 2.20 lb

WW 1×E14×40 W max(not included)
USA 1×E12×40 W max(not included)



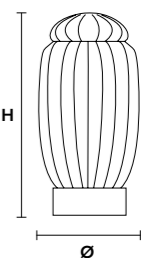
Ø 14 cm / 5.50"
H 30 cm / 11.90"
W 1.5 kg / 3.31 lb

WW 1×E14×40 W max(not included)
USA 1×E12×40 W max(not included)



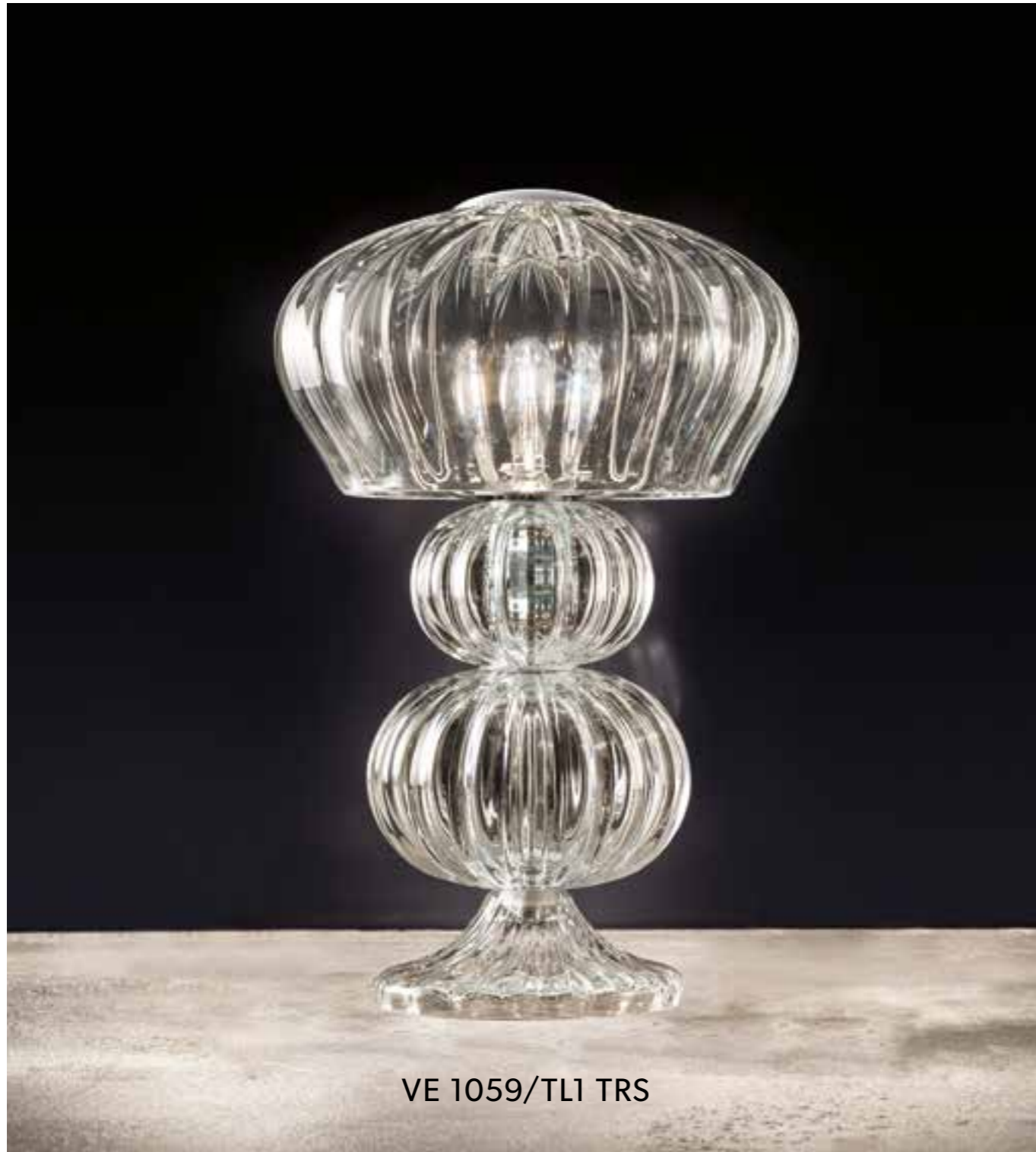
Ø 11 cm / 4.30"
H 23 cm / 9.00"
W 1 kg / 2.20 lb

WW 1×E14×40 W max(not included)
USA 1×E12×40 W max(not included)



Ø 14 cm / 5.50"
H 30 cm / 11.90"
W 1.5 kg / 3.31 lb

WW 1×E14×40 W max(not included)
USA 1×E12×40 W max(not included)



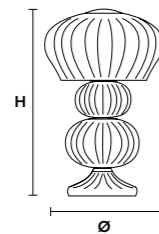
VE 1059/TL1 TRS



VE 1023/TL1 G

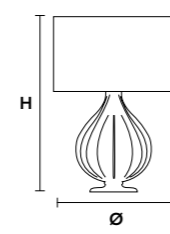
VE 1023/TL1 P

VE 1059/TL1 TRS VE 1023/TL1 G VE 1023/TL1 P



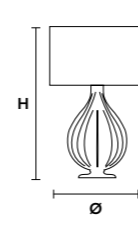
Ø 20 cm / 7.90"
H 30 cm / 11.90"
W 2 kg / 4.41 lb

WW 1×E14×40 W max(not included)
USA 1×E12×40 W max(not included)



Ø 32 cm / 12.59"
H 58 cm / 22.80"
W 4 kg / 8.82 lb

WW 1×E14×40 W max(not included)
USA 1×E12×40 W max(not included)

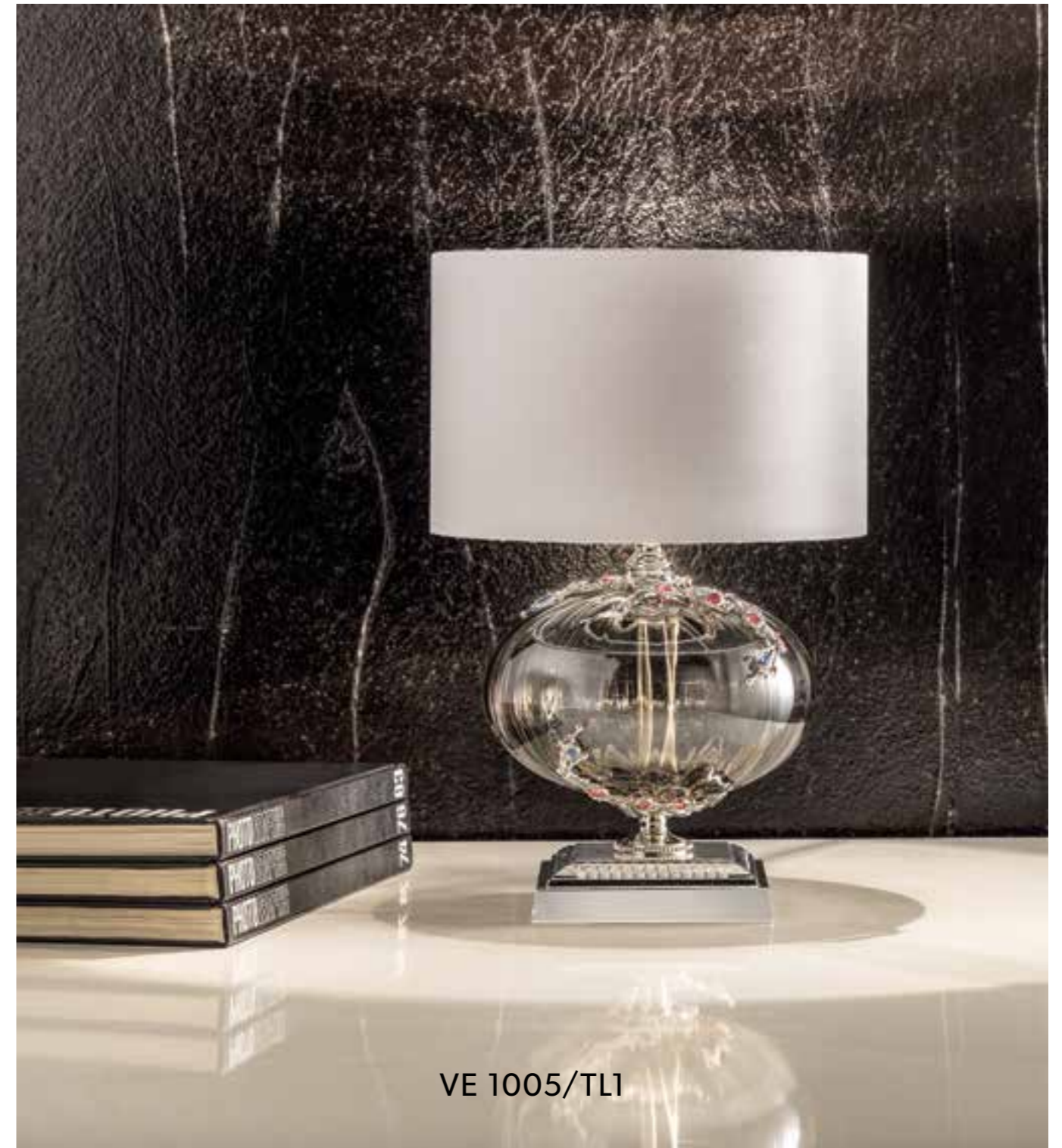


Ø 20 cm / 7.90"
H 37 cm / 14.60"
W 1.5 kg / 3.30 lb

WW 1×E14×40 W max(not included)
USA 1×E12×40 W max(not included)



VE 1007/TL1

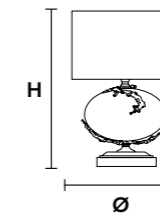
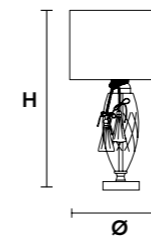


VE 1005/TL1

VE 1007/TL1



VE 1005/TL1



Ø 32 cm / 12.59"
H 58 cm / 22.80"

Ø 23 cm / 9.00"
H 34 cm / 14.00"
W 2 kg / 4.40 lb

WW 1×E27×60 W max (not included)
USA 1×E26×60 W max (not included)

WW 1×E27×60 W max (not included)
USA 1×E26×60 W max (not included)



VE 1008/TL1

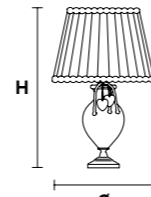
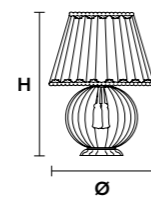


VE 1010/TL1

VE 1008/TL1



VE 1010/TL1

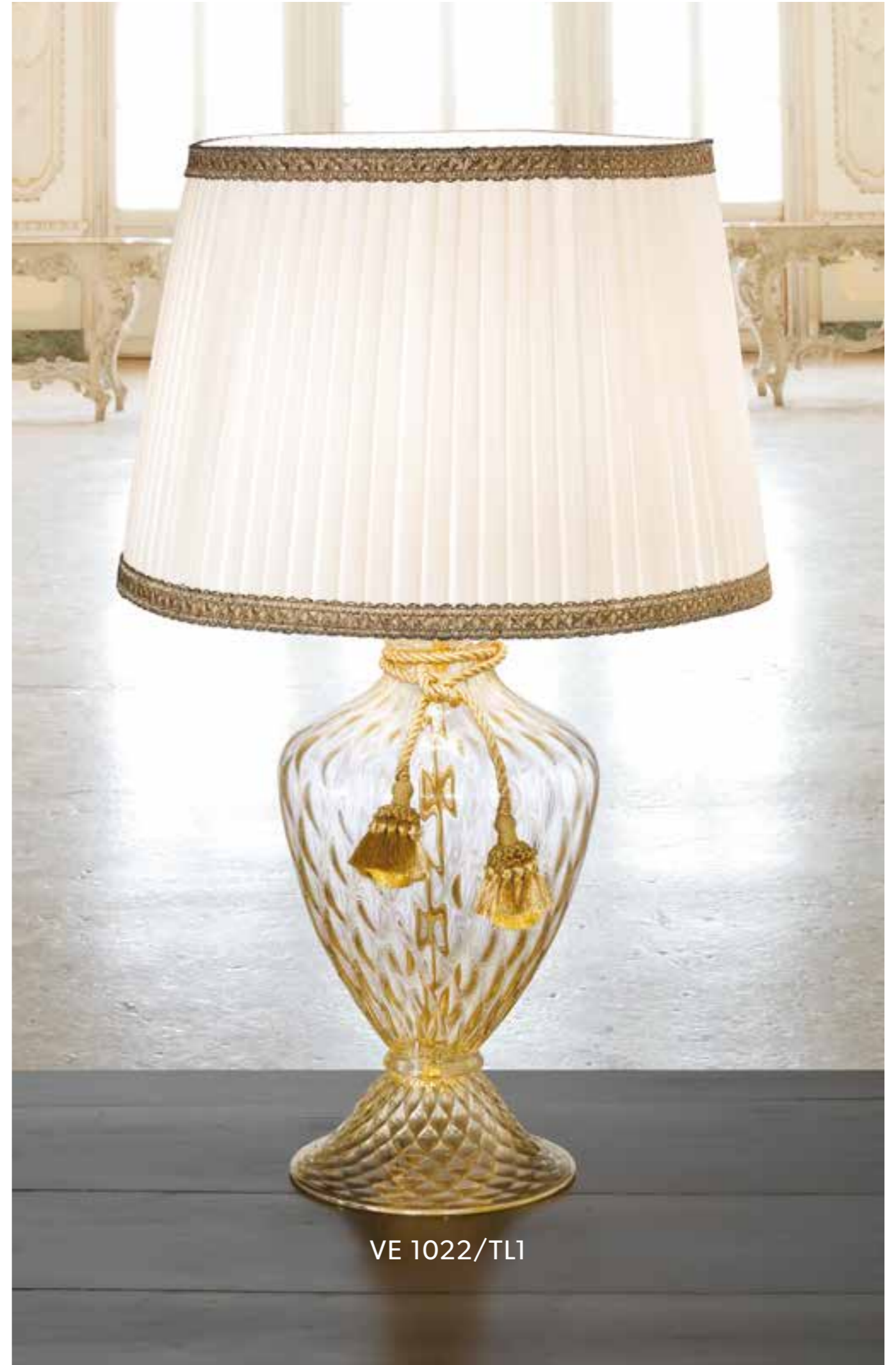


Ø 30 cm / 11.80"
H 41 cm / 16.20

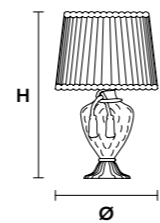
Ø 40 cm / 15.74"
H 65 cm / 25.59"

WW 1×E27×60 W max (not included)
USA 1×E26×60 W max (not included)

WW 1×E27×60 W max (not included)
USA 1×E26×60 W max (not included)



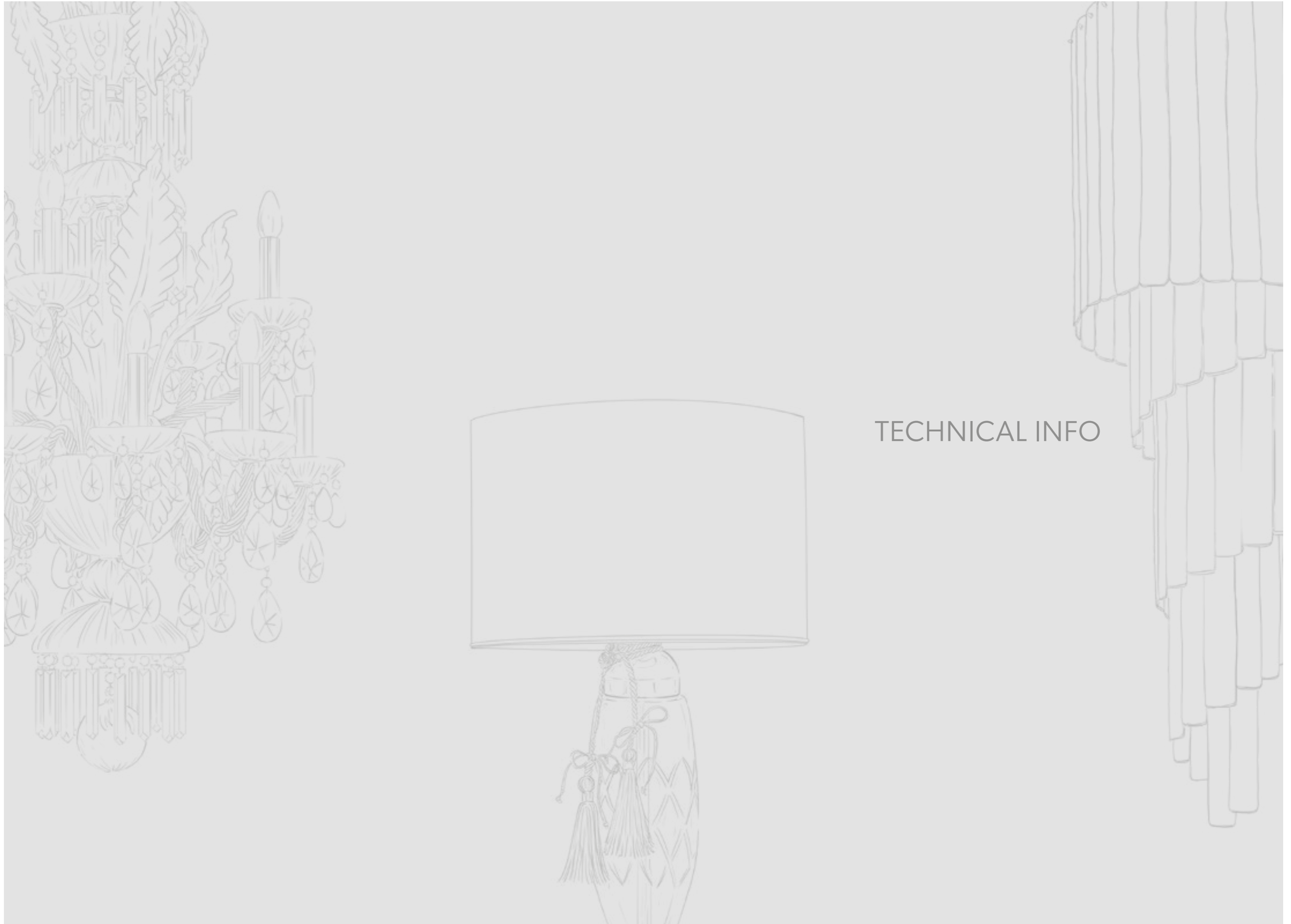
VE 1022/TL1 



Ø 48 cm / 18.90"
H 76 cm / 30.00"

WW 1×E27×60 W max (not included)
USA 1×E26×60 W max (not included)

VE 1022/TL1



TECHNICAL INFO

FINITURE / FINISHING

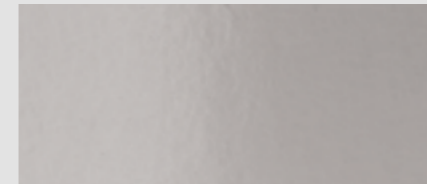
Bagno galvanico / Galvanic Bath



G07 Nickel spazzolato
Brushed nickel



G06 Cromo opaco
Matt chrome



G04 Cromo lucido
Shiny chrome



G21 Cromo anticato
Antiqued chrome



G14 Ottone brunito
Burnished brass



G01 Brunito
Burnished



G05 Oro opaco
Matt gold



G03 Oro lucido
Shiny gold



G12 Oro spazzolato
Brushed gold



G20 Oro anticato
Antiqued gold



G18 Ottone spazzolato
Brushed brass

Verniciati / Painted



V71 Nickel opaco verniciato
Painted matt nickel



V93 Oro verniciato
Painted gold

Verificare la disponibilità di ciascuna finitura per specifici articoli / Availability of each finish to be confirmed for specific items.

Indice/Index

COD.	Ø/L-SP	H	PAG.
VE 871/32	Ø 110 cm	H 270 cm	11
VE 871/64	Ø 140 cm	H 500 cm	10
VE 871/A3	L 50 - SP 28 cm	H 54 cm	9
VE 871/A5	L 50 - SP 28 cm	H 54 cm	8
VE 871/A12	L 75 - SP 30 cm	H 140 cm	9
VE 873/24	Ø 145 cm	H 175 cm	5
VE 873/A5	L 53 - SP 30 cm	H 50 cm	7
VE 874/6	Ø 77 cm	H 63 cm	16
VE 874/8	Ø 88 cm	H 76 cm	17
VE 874/5+5	Ø 88 cm	H 112 cm	14
VE 874/12	Ø 103 cm	H 80 cm	15
VE 874/16+8	Ø 95 cm	H 110cm	13
VE 874/A2	L 35 - SP 22 cm	H 26 cm	19
VE 874/A3	L 44 - SP 26 cm	H 26 cm	18
VE 875/12	Ø 120 cm	H 120 cm	20
VE 875/16	Ø 145 cm	H 120 cm	21
VE 875/A3	L 48 - SP 35 cm	H 50 cm	23
VE 886/12	Ø 70 cm	H 130 cm	25
VE 886/A3	L 48 - SP 28 cm	H 40 cm	27
VE 886/A5	L 50 - SP 30 cm	H 60 cm	26
VE 886/PL3	Ø 45 cm	H 40 cm	29
VE 1005/TL1	Ø 23 cm	H 34 cm	73
VE 1007/TL1	Ø 32 cm	H 58 cm	72
VE 1008/TL1	Ø 30 cm	H 41 cm	74
VE 1010/TL1	Ø 40 cm	H 65 cm	75
VE 1022/TL1	Ø 48 cm	H 76 cm	77
VE 1023/TL1 G	Ø 32 cm	H 58 cm	71
VE 1023/TL1 P	Ø 20 cm	H 37 cm	71
VE 1049/TL1 G G04 - G G14	Ø 14 cm	H 30 cm	68-69
VE 1049/TL1 P G04 - P G14	Ø 11 cm	H 23 cm	69
VE 1050/TL1 G	Ø 30 cm	H 26 cm	64
VE 1050/TL1 P	Ø 20 cm	H 22 cm	64
VE 1051/TL1 G	Ø 30 cm	H 26 cm	64
VE 1051/TL1 P	Ø 20 cm	H 22 cm	65
VE 1052/TL1 G	Ø 32 cm	H 50 cm	63
VE 1052/TL1 P	Ø 25 cm	H 38 cm	62

COD.	Ø/L-SP	H	PAG.
VE 1053/TL1 G	Ø 32 cm	H 50 cm	62
VE 1053/TL1 P	Ø 25 cm	H 38 cm	63
VE 1054/TL1 MOK - TRS	Ø 23 cm	H 37 cm	67
VE 1055/TL1	Ø 18 cm	H 35 cm	61
VE 1056/TL1 BLU - YEL	Ø 18 cm	H 35 cm	60
VE 1057/TL1	Ø 29 cm	H 49 cm	59
VE 1058/TL1	Ø 29 cm	H 49 cm	59
VE 1059/TL1 TRS	Ø 20 cm	H 30 cm	70
VE 1110/A1+1	L 45 - SP 23 cm	H 60 cm	49
VE 1110/PL5+3+2	Ø 100 cm	H 60 cm	50
VE 1110/PL12+2	Ø 140 cm	H 85 cm	51
VE 1112/A1+1	L 40 - SP 20 cm	H 55 cm	53
VE 1112/PL6+3+3	Ø 110 cm	H 70 cm	52
VE 1114/PL3 AMB - TR	Ø 45 cm	H 12 cm	54
VE 1115/PL5 AMB - TR	Ø 65 cm	H 15 cm	54-55
VE 1116/A2 AMB - TR	L 28 - SP 15 cm	H 38 cm	56-57
VE 1120/28	Ø 170 cm	H 150 cm	41
VE 1120/A2	L 38 - SP 20 cm	H 40 cm	43
VE 1120/PL12	L 80 - SP 80 cm	H 80 cm	36
VE 1120/PL14	L 100 - SP 100 cm	H 80 cm	36
VE 1120/PL16	L 120 - SP 120 cm	H 80 cm	37
VE 1144/S20	Ø 50 cm	H 230 cm	35
VE 1144/S30	Ø 80 cm	H 360 cm	34
VE 1144/S40	Ø 100 cm	H 450 cm	34
VE 1144/S52	Ø 120 cm	H 500 cm	34
VE 1145/S6	Ø 52 cm	H 50 cm	46
VE 1145/S14	Ø 80 cm	H 75 cm	47
VE 1145/S20	Ø 100 cm	H 110 cm	46
VE 1145/S8 OV	L 85 - SP 52 cm	H 50 cm	44
VE 1145/S14 OV	L 120 - SP 52 cm	H 50 cm	45
VE 1145/S20 OV	L 155 - SP 52 cm	H 50 cm	44
VE 1146/A4	L 26 - SP 14 cm	H 70 cm	32
VE 1146/PL14	Ø 70 cm	H 140 cm	31
VE 1147/PL16	L 120 - SP 60 cm	H 50 cm	39
VE 1149/S7	Ø 40 cm	H 90 cm	33
VE 1149/S16	Ø 50 cm	H 160 cm	32

CE

Attesta la conformità del prodotto alle disposizioni delle Direttive comunitarie.

It certifies the conformity of the products to the European Community provisions.

Il atteste la conformité du produit aux dispositions des directives communitaires.

Konformität des Produktes mit den Richtlinien der europäischen Gemeinschaft.

НАСТОЯЩИМ ПОДТВЕРЖДАЕТСЯ СООТВЕТСТВИЕ ПРОДУКЦИИ ПОЛОЖЕНИЯМ ДИРЕКТИВ ЕС.

Certifica la conformidad del producto según las disposiciones de las directivas comunitarias.

CE标记是指产品的制造商证明该产品符合适用的EC指令的所有基本要求。

يُشهد بمطابقة المنتج لأحكام توجيهات المجتمع الأوروبي.



Il logo "ETL" si riferisce agli articoli che possono essere modificati con componenti certificati ETL. L'elenco degli articoli ETL si riferisce a prodotti testati e valutati in base agli standard di sicurezza del mercato statunitense. Per il mercato USA fare riferimento al listino dedicato.

"ETL" logos refers to articles which can be modified with ETL-compliance components. The "ETL" listing articles stands for tested and evaluated product to recognised US safety standards. For the US market, refer to the relevant price list.

"ETL" logo se réfère aux articles qui peuvent être modifiés par des composants certifiés ETL. la liste des articles ETL se réfère à des produits testés et évalués selon les normes de sécurité du marché américain. Pour le marché américain se référer à la liste des prix.

Das "ETL"-Logo bezieht sich auf Artikel, die mit ETL-zertifizierten Komponenten modifiziert werden können. Die Liste der ETL-Artikel bezieht sich auf Produkte, die nach den Sicherheitsstandards des US-Marktes getestet und bewertet wurden. Für den US-Markt beachten Sie bitte die entsprechende Preisliste.

ЛОГОТИП «ETL» ОТНОСИТСЯ К ЭЛЕМЕНТАМ, КОТОРЫЕ МОГУТ БЫТЬ МОДИФИЦИРОВАНЫ С ПОМОЩЬЮ СЕРТИФИЦИРОВАННЫХ ETL КОМПОНЕНТОВ. СПИСОК ЭЛЕМЕНТОВ ETL ОТНОСИТСЯ К ПРОДУКЦИИ, ПРОТЕСТИРОВАННОЙ И ОЦЕНЕННОЙ В СООТВЕТСТВИИ С ПРИЗНАННЫМИ СТАНДАРТАМИ БЕЗОПАСНОСТИ США. ДЛЯ ПОТРЕБИТЕЛЕЙ НАХОДЯЩИХСЯ В США СМ. СООТВЕТСТВУЮЩИЙ ПРАЙС-ЛИСТ.

El logo "ETL" indica los artículos, que pueden modificarse con componentes certificados ETL. La lista de los artículos ETL se refiere a los productos sometidos a prueba y evaluados en función de los estándares de seguridad del mercado estadounidense. Consultar la lista de precios específica para el mercado de los Estados Unidos.

"ETL" 徽标是指可以使用ETL认证的组件进行修改的项目。 ETL项目列表是指根据美国市场的安全标准进行测试和评估的产品。 对于美国市场, 请参考美国市场价格表。

يشير شعار «ETL» إلى المنتجات التي يمكن تعديلها باستخدام مكونات مُعتمدة من ETL. تشير قائمة منتجات ETL إلى المنتجات التي تم اختبارها وتقييمها وفقًا لمعايير السلامة في السوق الأمريكي. بالنسبة لسوق الولايات المتحدة الأمريكية، يُرجى الرجوع إلى قائمة الأسعار المُخصصة.

قائمة الأسعار المُخصصة.

lm

Flusso luminoso nominale. L'indicazione si riferisce al valore in assenza di rifrazione, come dichiarato dal produttore del componente.

Nominal luminous flux. It refers to the value without any refraction, as declared by the component manufacturer.

L'unité SI de flux lumineux. L'indication correspond à la valeur en l'absence de réfraction, comme indiqué par le fabricant du composant.

Die Maßeinheit für den Lichtstrom. Die Angabe bezieht sich auf den Wert in der Abwesenheit von Brechung, wie vom Hersteller der Komponente angegeben.

НОМИНАЛЬНЫЙ СВЕТОВОЙ ПОТОК. УКАЗАНИЕ ОТНОСИТСЯ К ЗНАЧЕНИЮ В ОТСУТСТВИЕ РЕФРАКЦИИ, КАК ЗАЯВЛЕНО ПРОИЗВОДИТЕЛЕМ КОМПОНЕНТОВ.

Flujo luminoso nominal. La indicación se refiere al valor sin refracción, como declarado por el fabricante del componente.

标称光通量。指示是指组件制造商声明的没有折射的值。

التدفق الضوئي الاسمي. يشير المؤشر إلى القيمة في حالة عدم وجود انكسار للضوء، كما هو مُعلن من قبل الشركة المصنعة للعنصر.

MASIERO

Masiero si riserva il diritto di apportare ai propri articoli, senza nessun preavviso, qualsiasi modifica ritenesse opportuna.

Masiero reserves the right to introduce any changes to its own products, without notice in advance.

Masiero se réserve le droit d'apporter une quelconque modification à les modèles sans préavis.

Masiero behält sich das Recht vor Änderungen vorzunehmen, ohne sofortige Benachrichtigung.

КОМПАНИЯ MASIERO ОСТАВЛЯЕТ ЗА СОБОЙ ПРАВО БЕЗ ПРЕДВАРИТЕЛЬНОГО УВЕДОМЛЕНИЯ, ЕСЛИ ЭТО БУДЕТ СОЧТЕНО ЦЕЛЕСООБРАЗНЫМ, ВНОСИТЬ В СОБСТВЕННЫЕ МОДЕЛИ ЛЮБЫЕ ИЗМЕНЕНИЯ.

Masiero se reserva el derecho de aportar modificaciones consideradas oportunas a sus artículos sin preaviso.

Masiero 保留对其认为适当的任何更改的权利, 恕不另行通知。

تحتفظ شركة مازيرو "Masiero" بالحق في إجراء أي تعديلات تراها مناسبة على منتجاتها، دون إشعار مسبق.

Masiero srl

via Peschiere, 53
31032 Casale sul Sile
Treviso, Italy
T +39 0422 7861
F +39 0422 786250

info@masierogroup.com
masierogroup.com

Design by Masiero
Photo, Studio Pointer
Print Italy, April 2021
by Grafica Antiga



PROGRAMS
ATELIER

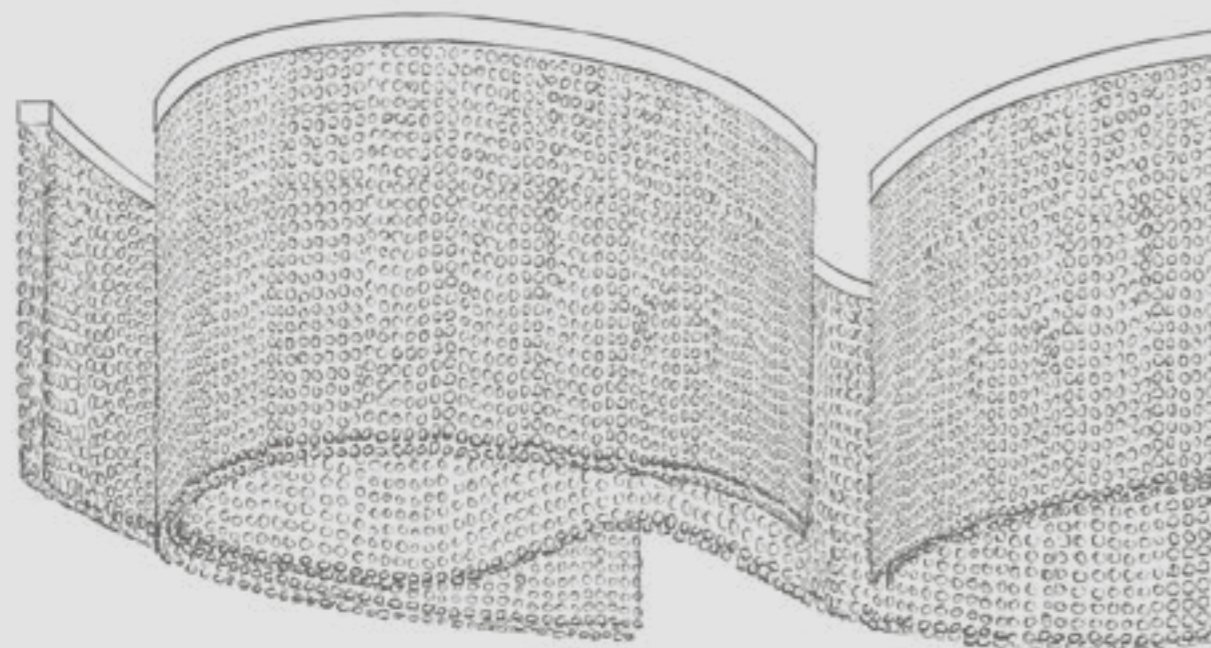
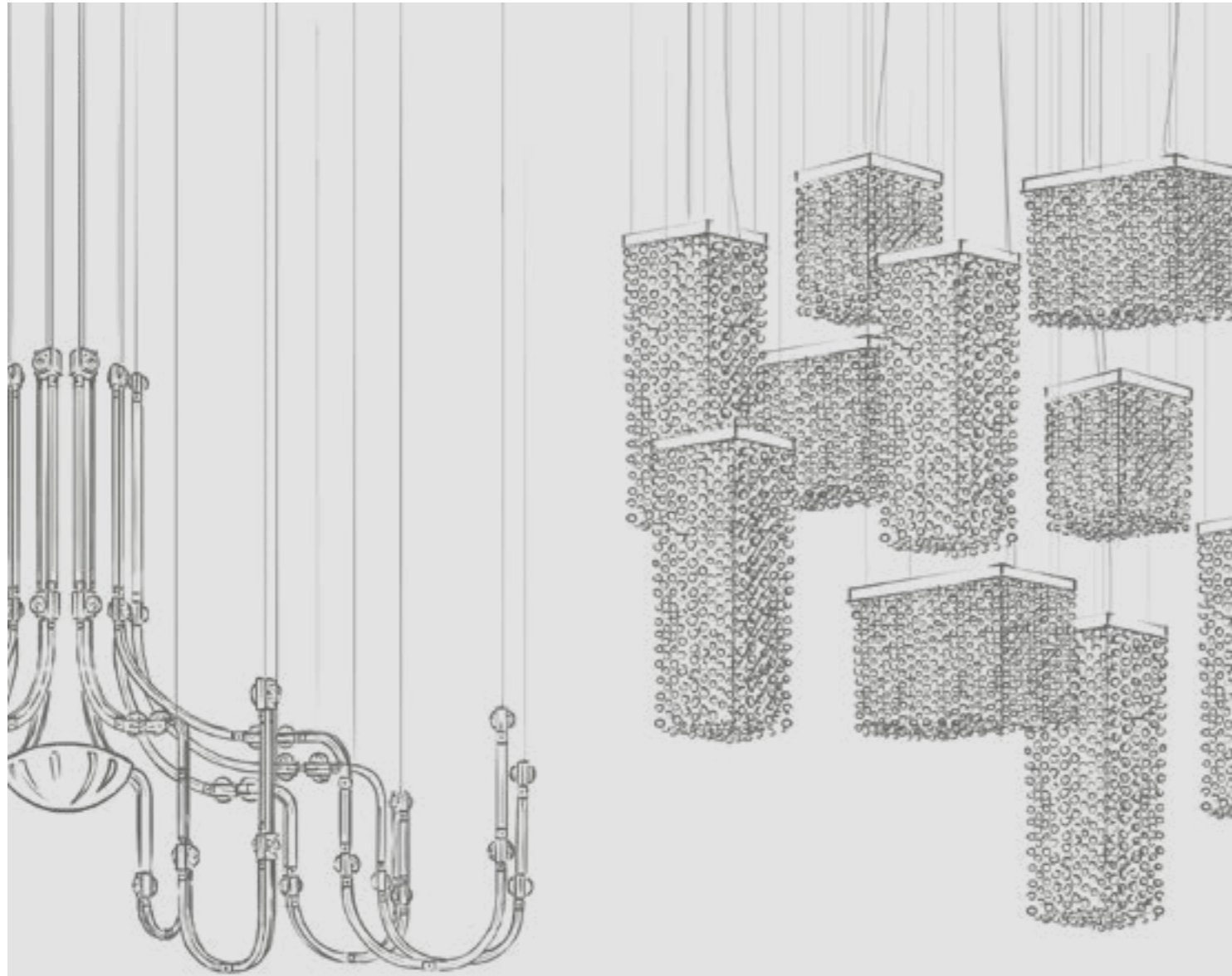
MASIERO



PROGRAMS

ATELIER

MASIERO



PROGRAMS

Progettare significa scegliere e scegliere una lampada significa mettere in scena le proprie emozioni.

I prodotti Masiero sono al servizio del progettista, per aiutarlo a tradurre le idee in spazi illuminati.

L'esistenza di moduli combinabili su misura permette la realizzazione di soluzioni inedite, che costruiscono il sistema illuminante in base allo spazio, che da vincolo diventa opportunità.

Designing means choosing and choosing your lighting means acting out your emotions.

Masiero products are at the service of designers to help them translate ideas into illuminated spaces.

The existence of customised modular elements allows creation of unique solutions to construct lighting systems according to the space available, transforming it from constraint into opportunity.

RAQAM

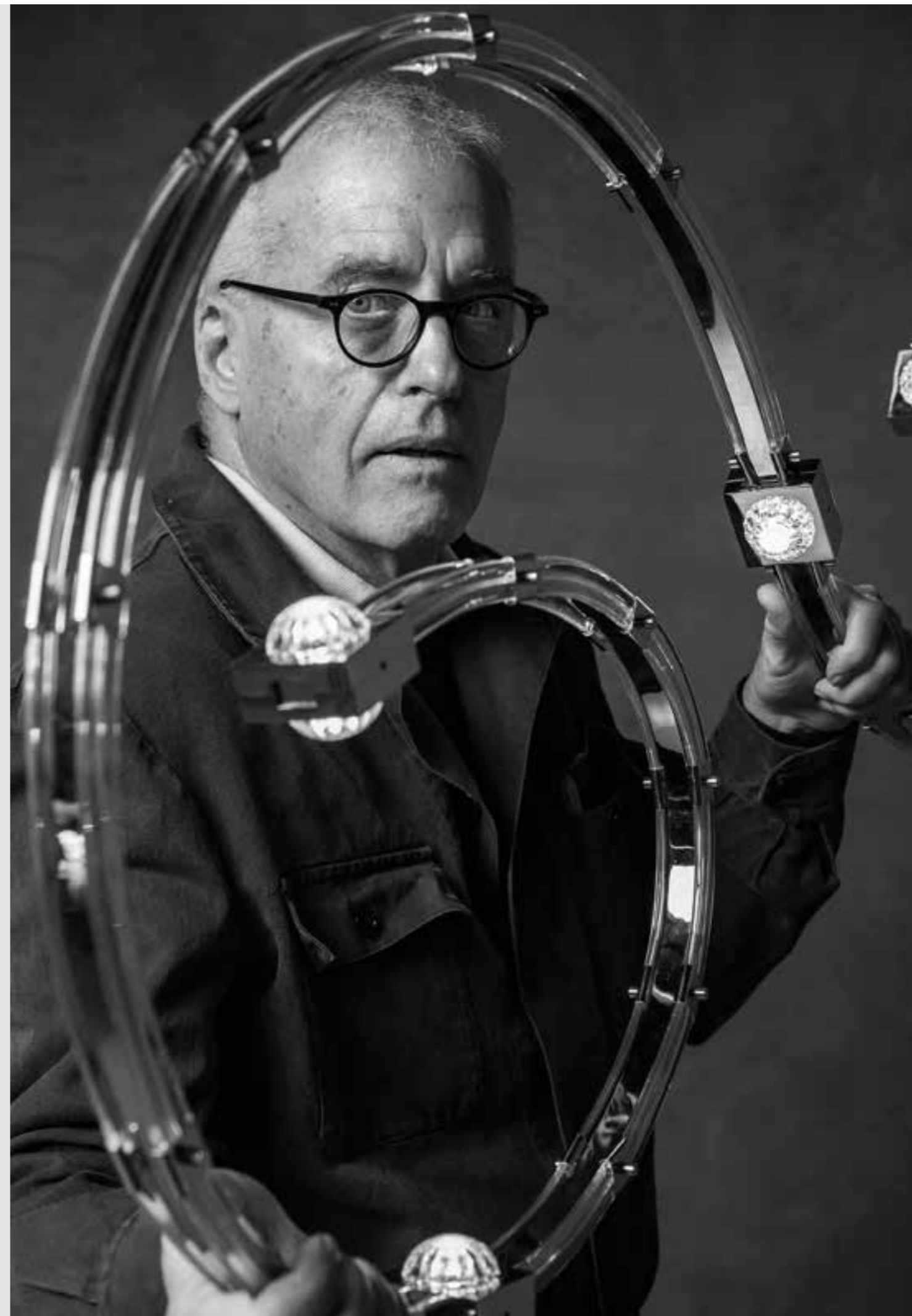
design by Marc Sadler

Raqam è il lampadario contemporaneo ad illuminazione Led costruito con combinazioni modulari personalizzabili.

E' declinabile su tutte le tipologie di superfici, senza limiti di dimensione. Dalla combinazione dei moduli si possono realizzare sospensioni verticali, chandelier, decorazioni a parete e a soffitto, sia per uso residenziale che contract.

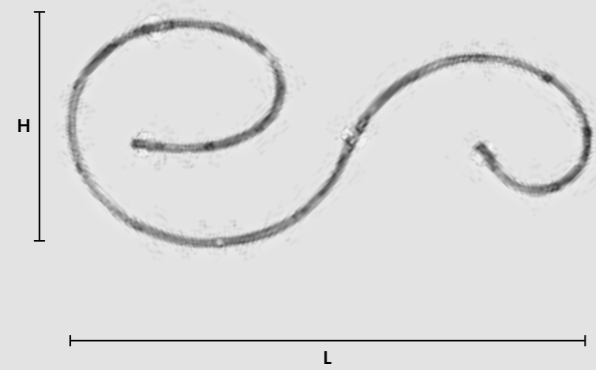
Raqam is a contemporary chandelier with LED lighting available in customisable modular combinations.

It can be used on all types of surface, with no size limits. Combinations of modules can be used to create vertical suspensions, chandeliers and wall and ceiling decorations for both residential and contract use.



MODULES

Module 1

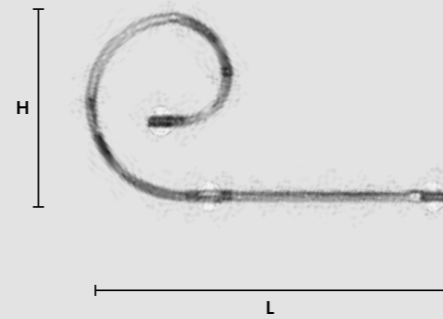


H 51,5 cm / 20.30"
L 114,5 cm / 45.10"
SP 5 cm / 1.96"

kg 3,1

8 LED LIGHTS CRI>80
3000 K - 12W - 1560 Nominal Lumen

Module 2

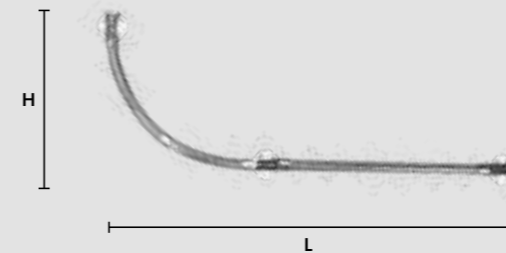


H 37,5 cm / 14.80"
L 68,5 cm / 27.00"
SP 5 cm / 1.96"

kg 2

6 LED LIGHTS CRI>80
3000K - 9W - 1170 Nominal Lumen

Module 3

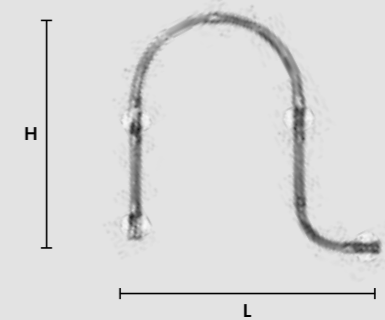


H 32 cm / 12.60"
L 79,5 cm / 31.30"
SP 5 cm / 1.96"

kg 1,2

6 LED LIGHTS CRI>80
3000K - 9W - 1170 Nominal Lumen

Module 4

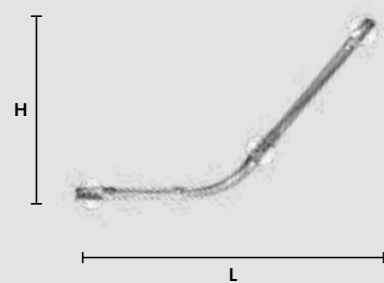


H 49 cm / 19.30"
L 47,5 cm / 18.70"
SP 5 cm / 1.96"

kg 1,5

8 LED LIGHTS CRI>80
3000K - 12W - 1560 Nominal Lumen

Module 5

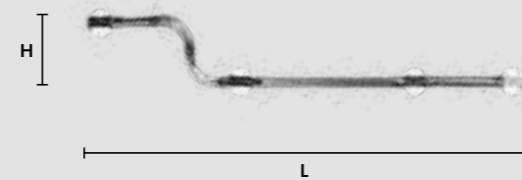


H 55 cm / 21.65"
L 36 cm / 14.20"
SP 5 cm / 1.96"

kg 1,2

6 LED LIGHTS CRI>80
3000K - 9W - 1170 Nominal Lumen

Module 6

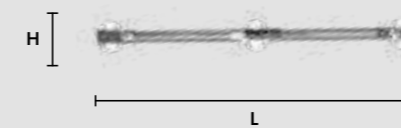


H 17,5 cm / 6.90"
L 92 cm / 36.25"
SP 5 cm / 1.96"

kg 1,5

8 LED LIGHTS CRI>80
3000 K - 12W - 1560 Nominal Lumen

Module 7



H 3,8 cm / 1.50"
L 58 cm / 22.85"
SP 5 cm / 1.96"

kg 1

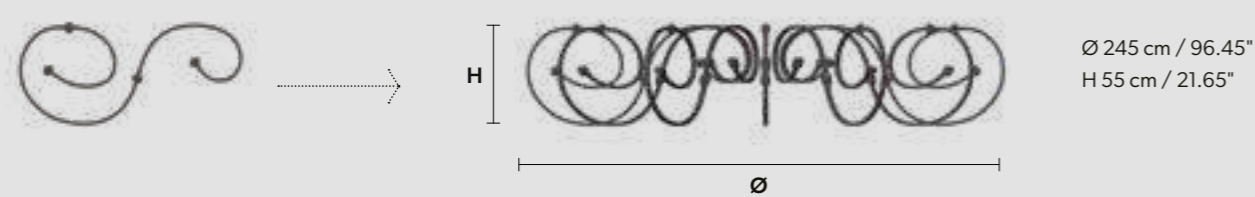
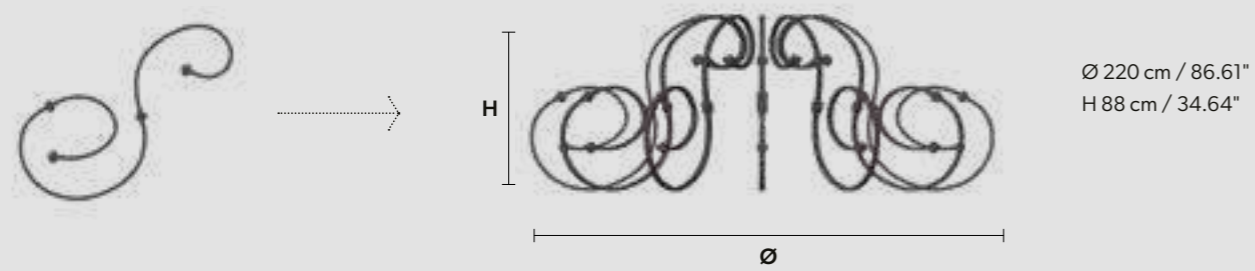
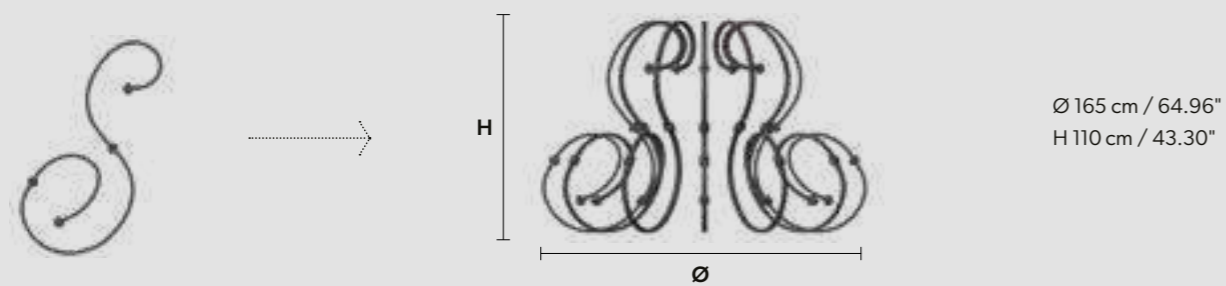
6 LED LIGHTS CRI>80
3000K - 9W - 1170 Nominal Lumen

THE POSSIBILITIES OF RAQAM MODULES

INFINITE ANGLES

The modules can be tilted to obtain different shapes and sizes.

Example: Module 1 x 12



RADIAL REPETITIONS

The same module, or different modules, can be positioned along a circumference.

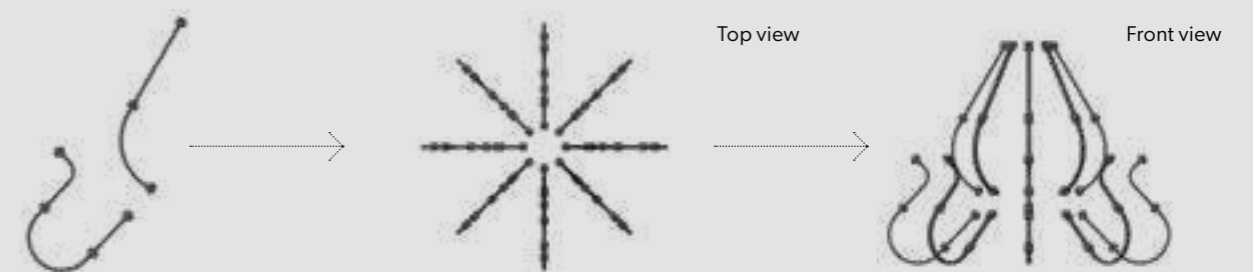
Example: Module 3 x 8



Example: Module 3 x 12



Example: Module 3 x 8 + Module 4 x 8

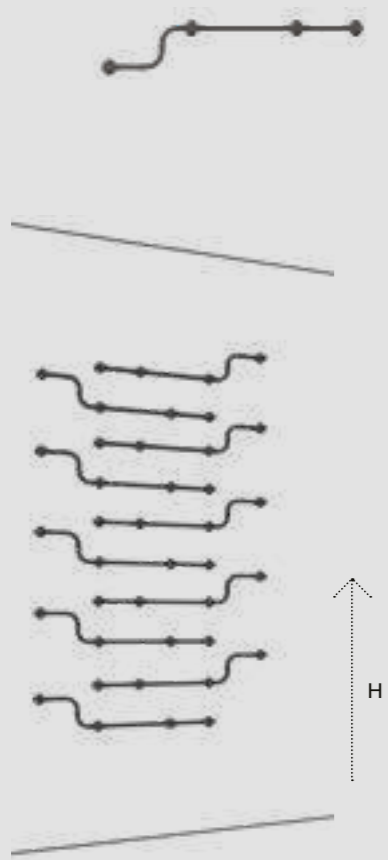


THE POSSIBILITIES OF RAQAM MODULES

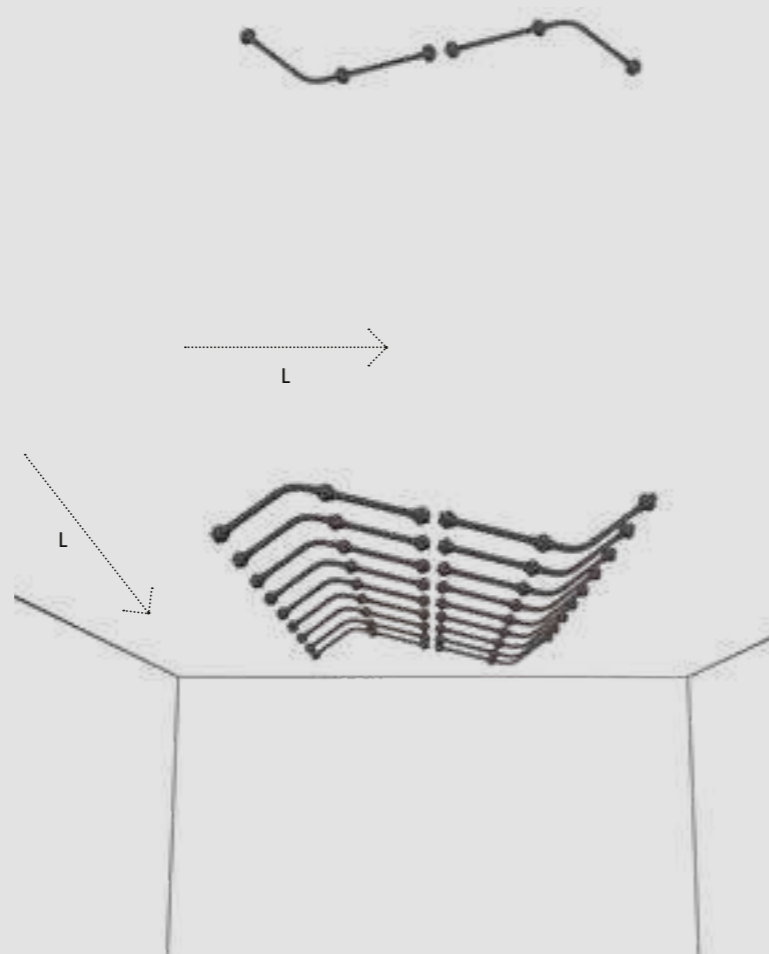
HEIGHT, LENGTH AND WIDTH REPEATS

The same or different modules can be positioned along walls or ceilings.

Example: Module 2



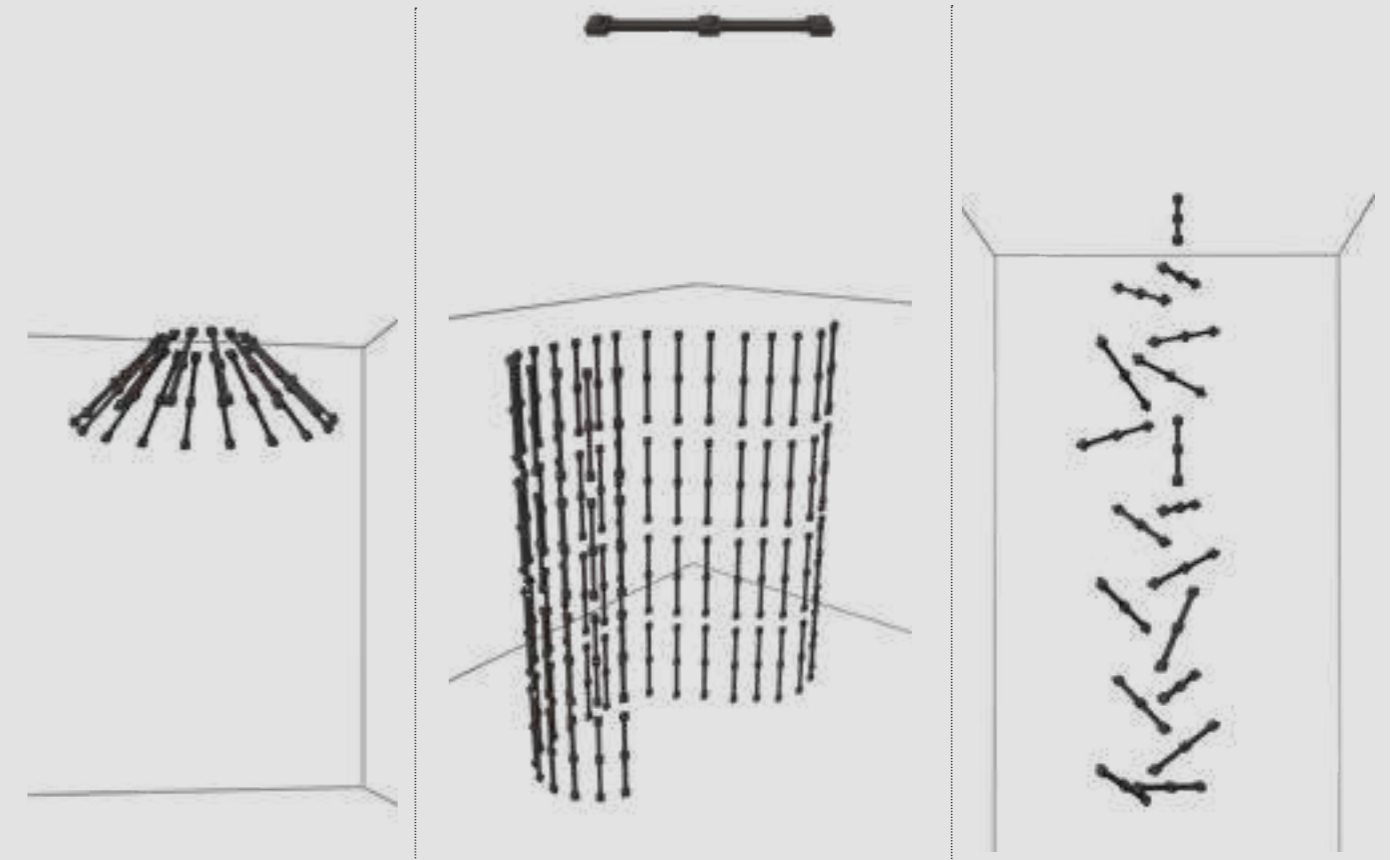
Example: Module 4



ONE MODULE, ENDLESS POSSIBILITIES

The same module can be used in different ways to create infinite combinations.

Example: Module 7



Radial repetitions

Height and width repeats

Height repeats with module inclination

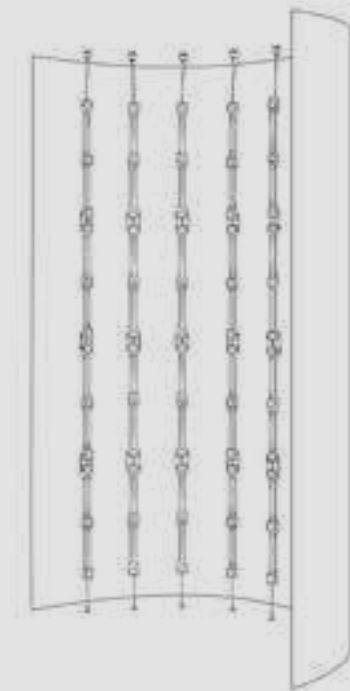
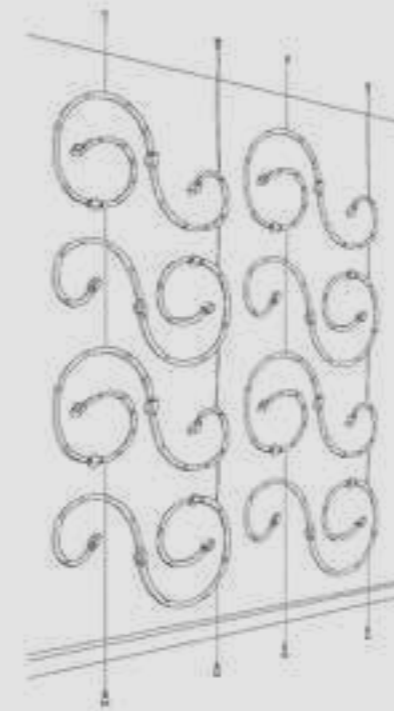
THE POSSIBILITIES OF RAQAM MODULES

Raqam provides endless possibilities for combining modules to decorate residential or contract environments with different shapes.

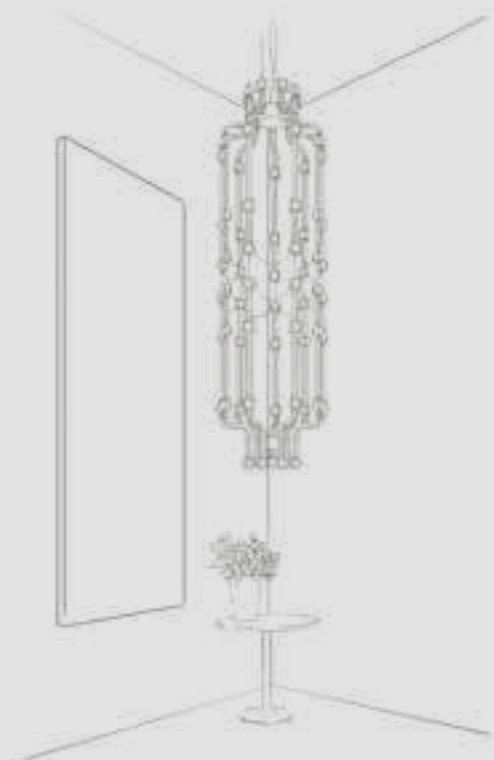
CHANDELIER SHAPE



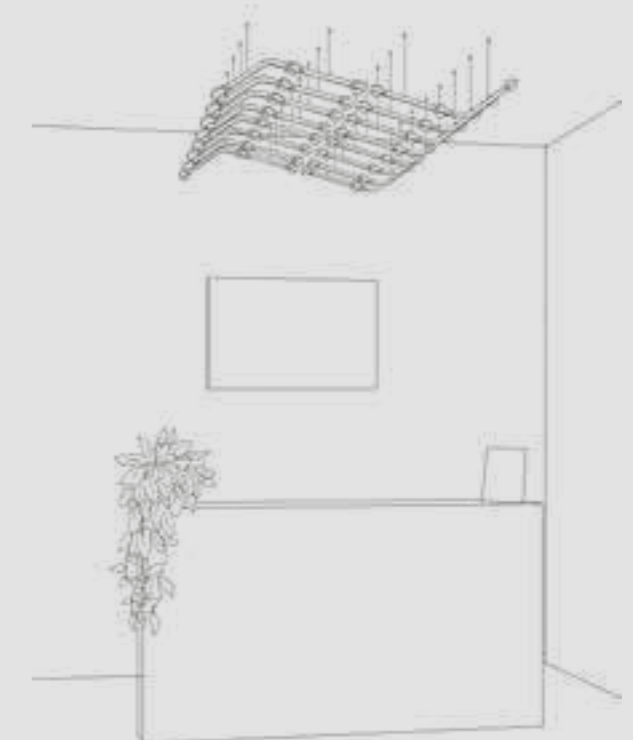
WALL SHAPE



VERTICAL SHAPE

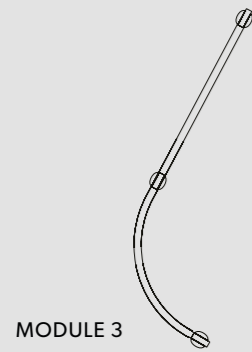


CEILING SHAPE



M1 CONCEPT Chandelier arrangement

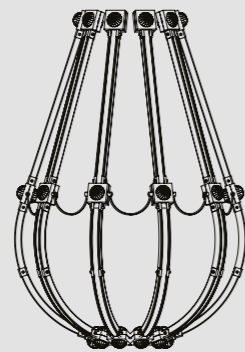
MODULES



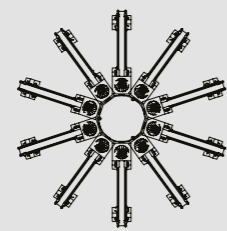
MODULE 3 X 10



RADIAL REPETITION

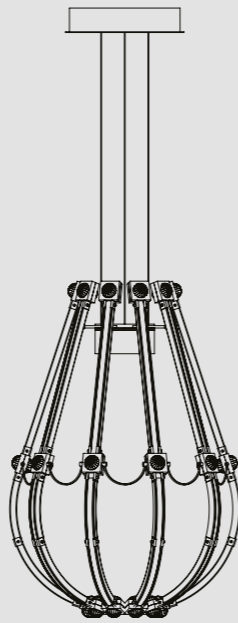


Front view



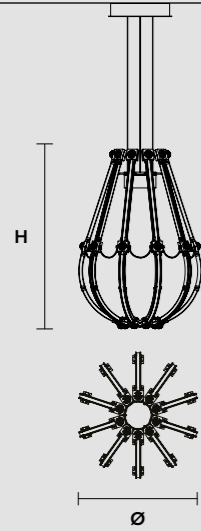
Top view

COMPOSITION



RAQAM M1 COMPOSITION

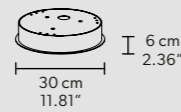
RAQAM M1 BASIC BATCH - MODULE 3 X 10



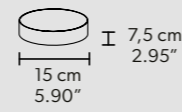
Ø 65 cm / 25.59"
 H 85 cm / 33.46"
 W 20 kg / 44.1 lb

60 LED LIGHTS CRI > 80
 3000K - 90W - 11700 Nominal Lumen
 Dimmable PUSH or DMX on request.

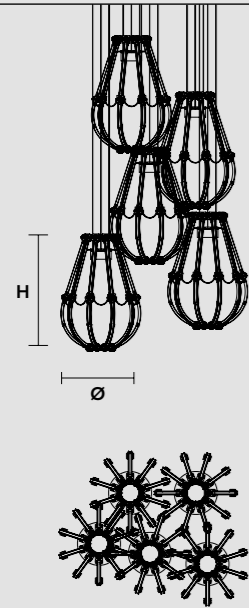
Fixing: 1 x canopy.
 The canopy contains:
 1 x driver



The box contains:
 1 x control board



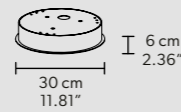
RAQAM M1 BASIC BATCH A - (MODULE 3 X 10) X 5



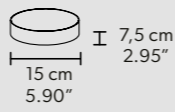
Ø 65 cm / 25.59"
 H 85 cm / 33.46"
 W 100 kg / 220.46lb

300 LED LIGHTS - 450W - 58500 Nominal Lumen
 Dimmable PUSH or DMX on request.

Fixing: 5 x canopy.
 Each canopy contains:
 1 x driver



Each box contains:
 1 x control board



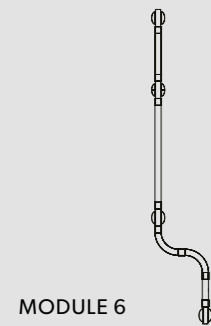
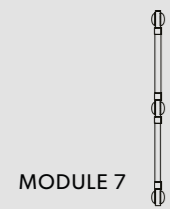
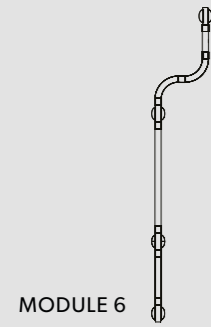
RAQAM M1 COMPOSITION



M6_M7 CONCEPT

Vertical arrangement

MODULES



RADIAL REPETITION

MODULE 6 X 10

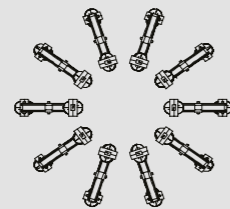
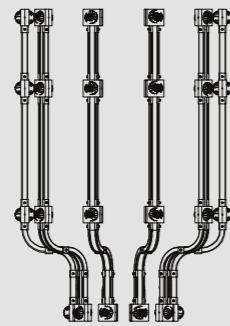
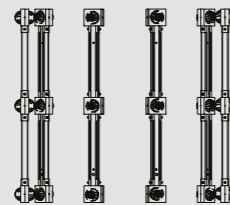
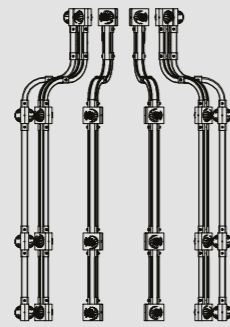
+

MODULE 7 X 10

(Additional element to increase the overall height)

+

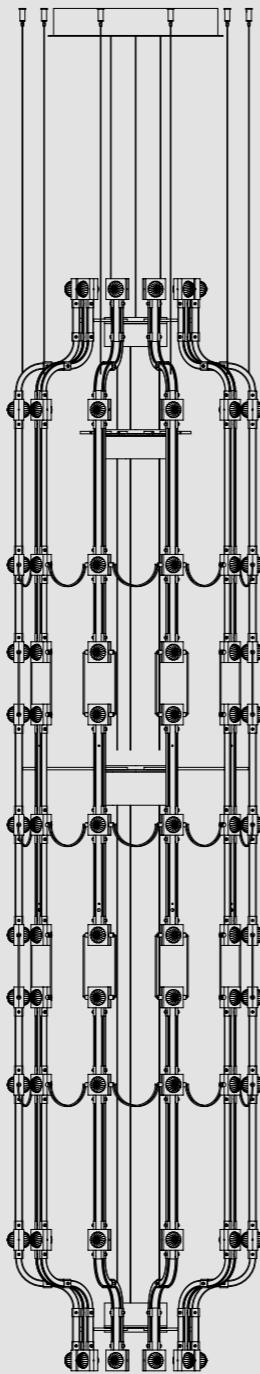
MODULE 6 X 10



Front view

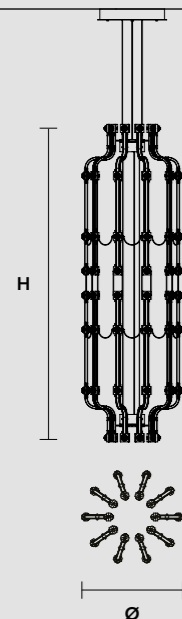
Top view

COMPOSITION



RAQAM M7 COMPOSITION

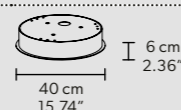
RAQAM M6 BASIC BATCH A - MODULE 6 X 20



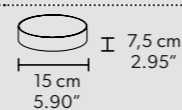
Ø 60 cm / 23.62"
 H 200 cm / 78.74"
 W 45 kg / 99.20 lb

LED x 240W CRI > 80
 3000K - 31200 Nominal Lumen
 Dimmable PUSH + DMX on request.

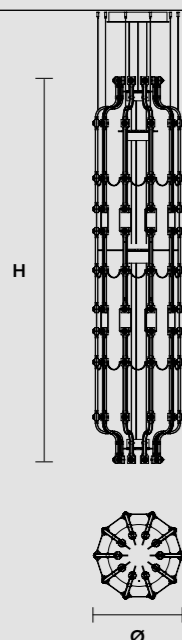
Fixing: 1 x canopy.
 The canopy contains:
 2 x driver



Each box contains:
 1 x control board



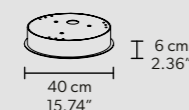
RAQAM M7 BASIC BATCH A - MODULE 6 X 20 + MODULE 7 X 10



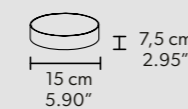
Ø 62 cm / 24.40"
 H 263 cm / 103.54"
 W 62 kg / 136.68 lb

220 LED LIGHTS CRI > 80
 3000 K - 330 W- 42900 Nominal Lumen
 Dimmable PUSH or DMX on request.

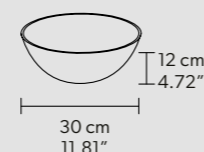
Fixing: 1 x canopy.
 10x single steel cables
 The canopy contains:
 2 x drivers



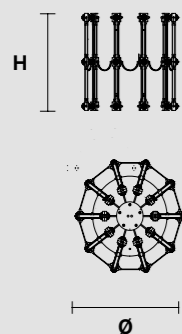
Each box contains:
 1 x control board.



Any additional element made of Module 7x10, requires one additional cup with driver and control board.



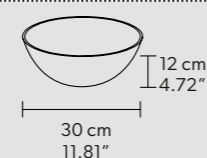
RAQAM M7 ADDITIONAL ELEMENT TO INCREASE THE OVERALL HEIGHT - MODULE 7 X 10



Ø 62 cm / 24.40"
 H 58 cm / 22.85"
 W 18 kg / 39.68 lb

60 LED LIGHTS CRI > 80
 3000 K - 90W- 11700 Nominal Lumen
 Dimmable PUSH or DMX on request.

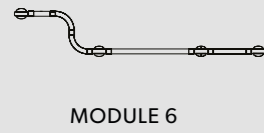
Any additional element made of Module 7x10, requires one additional cup with driver and control board



RAQAM M6

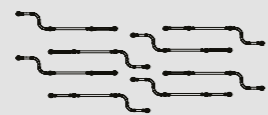
N2 CONCEPT Horizontal/Vertical arrangement

MODULES



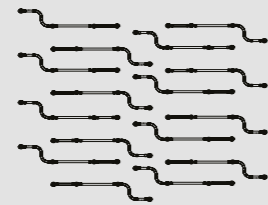
HORIZONTAL / VERTICAL REPETITION

MODULE 6 X 8



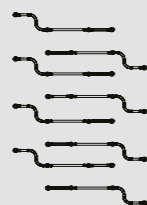
Front view

MODULE 6 X 16



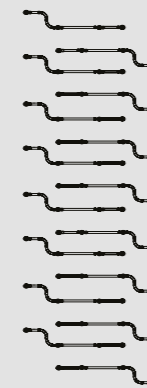
Front view

MODULE 6 X 8



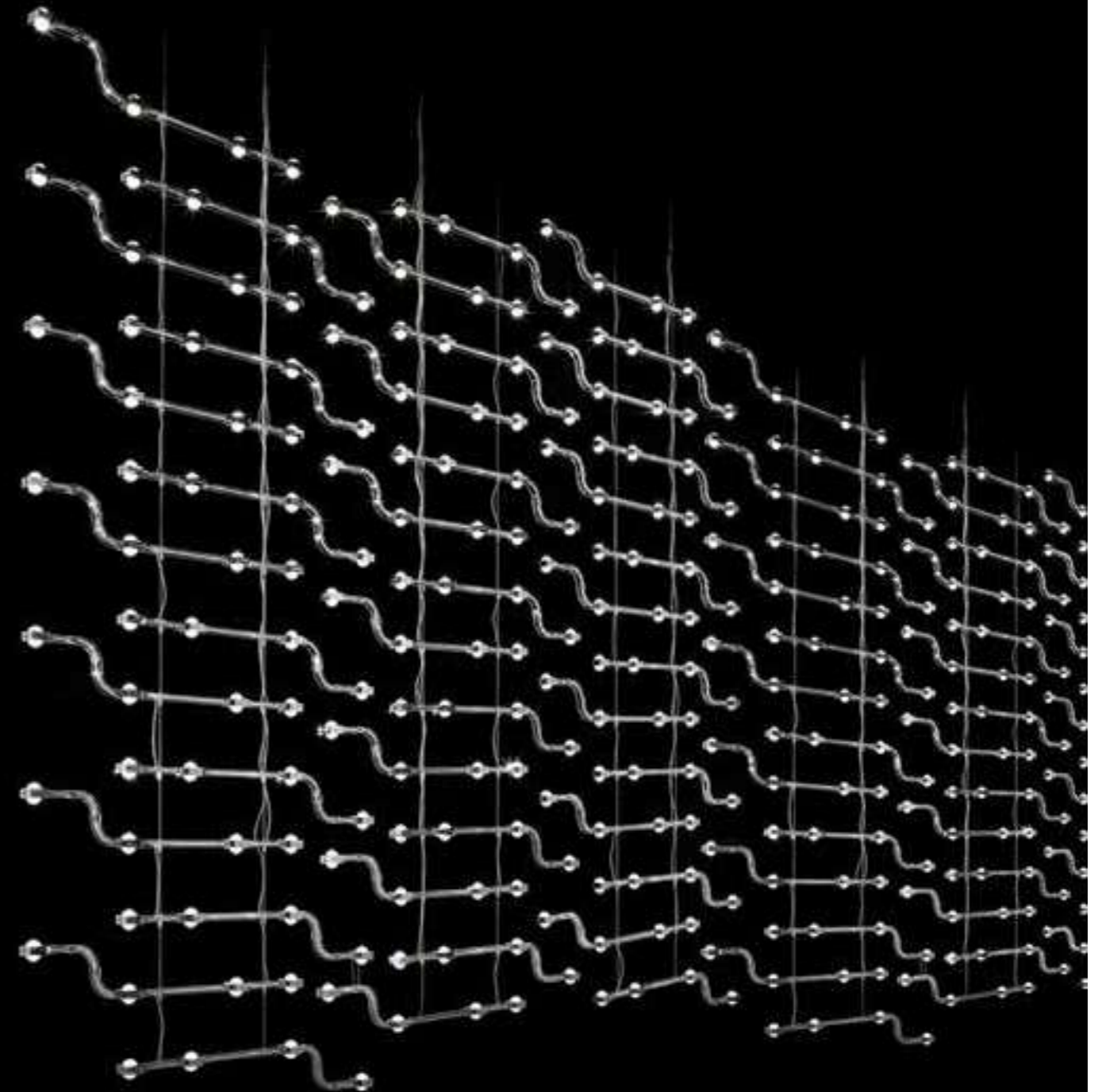
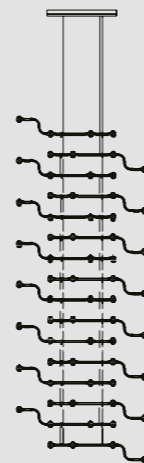
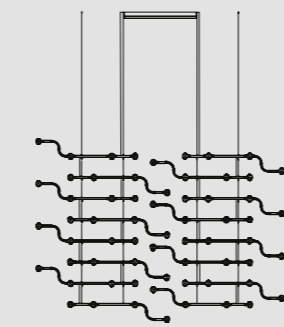
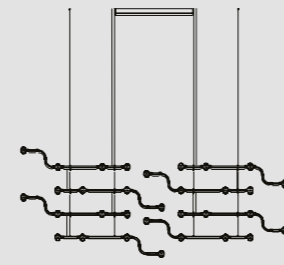
Front view

MODULE 6 X 16



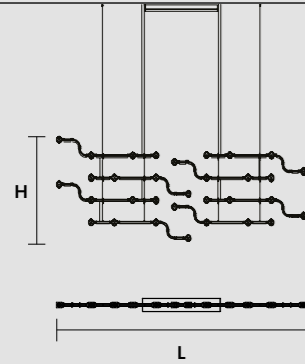
Front view

COMPOSITION



RAQAM N2 COMPOSITION

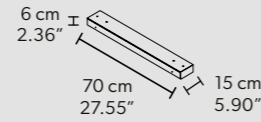
RAQAM N2 BASIC BATCH A8 - MODULE 6 X 8



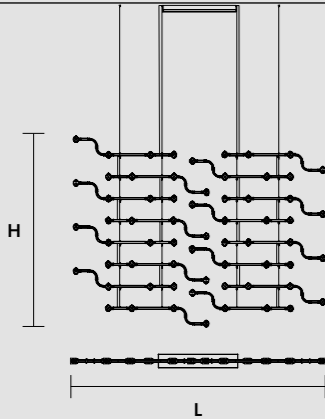
L 224,6 cm / 88.42"
 H 76 cm / 29.92"
 W 16 kg / 35.27 lb

64 LED LIGHTS CRI > 80
 3000 K - 96 W - 12480 Nominal Lumen
 Dimmable PUSH or DMX on request.

Fixing: 1 x canopy
 4 x single steel cables.
 The canopy contains:
 1 x driver
 1 x control board



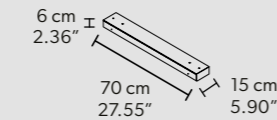
RAQAM N2 BASIC BATCH A16 - MODULE 6 X 16



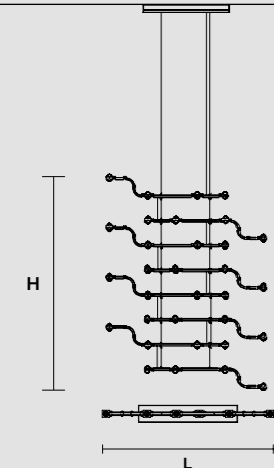
L 224,6 cm / 88.42"
 H 155 cm / 61.02"
 W 28 kg / 61.72 lb

128 LED LIGHTS CRI > 80
 3000 K - 192 W - 24960 Nominal Lumen
 Dimmable PUSH or DMX on request.

Fixing: 1 x canopy
 4 x single steel cables.
 The canopy contains:
 1 x driver
 1 x control board



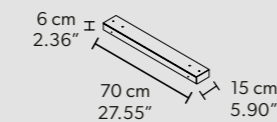
RAQAM N2 BASIC BATCH B8 - MODULE 6 X 8



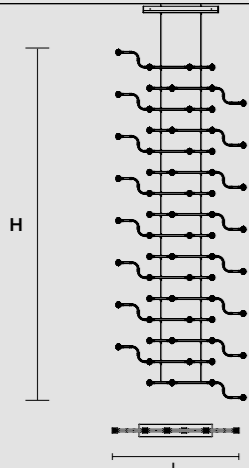
L 121,3 cm / 47.75"
 H 155 cm / 61.02 "
 W 16 kg / 35.27 lb

64 LED LIGHTS CRI > 80
 3000 K - 96 W - 12480 Nominal Lumen
 Dimmable PUSH or DMX on request.

Fixing: 1 x canopy.
 The canopy contains:
 1 x driver
 1 x control board



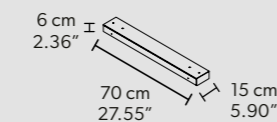
RAQAM N2 BASIC BATCH B16 - MODULE 6 X 16



L 121,3 cm / 47.75"
 H 311 cm / 112.44"
 W 28 cm / 61.72 lb

128 LED LIGHTS CRI > 80
 3000 K - 192 W - 24960 Nominal Lumen
 Dimmable PUSH or DMX on request.

Fixing: 1 x canopy.
 The canopy contains:
 1 x driver
 1 x control board

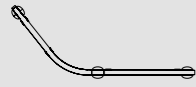


RAQAM N2 COMPOSITION

N3 CONCEPT

Linear arrangement

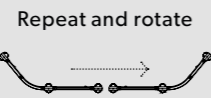
MODULES



MODULE 5

REPETITION IN LENGTH AND WIDTH

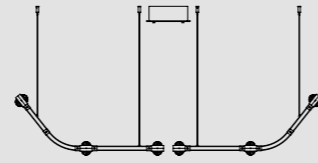
MODULE 5 X 8



Repeat in length

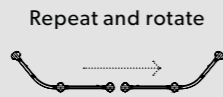


Front view

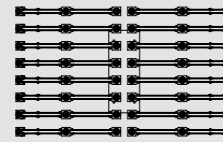


Top view

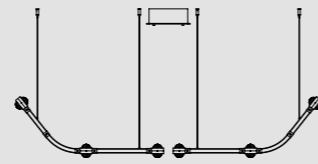
MODULE 5 X 16



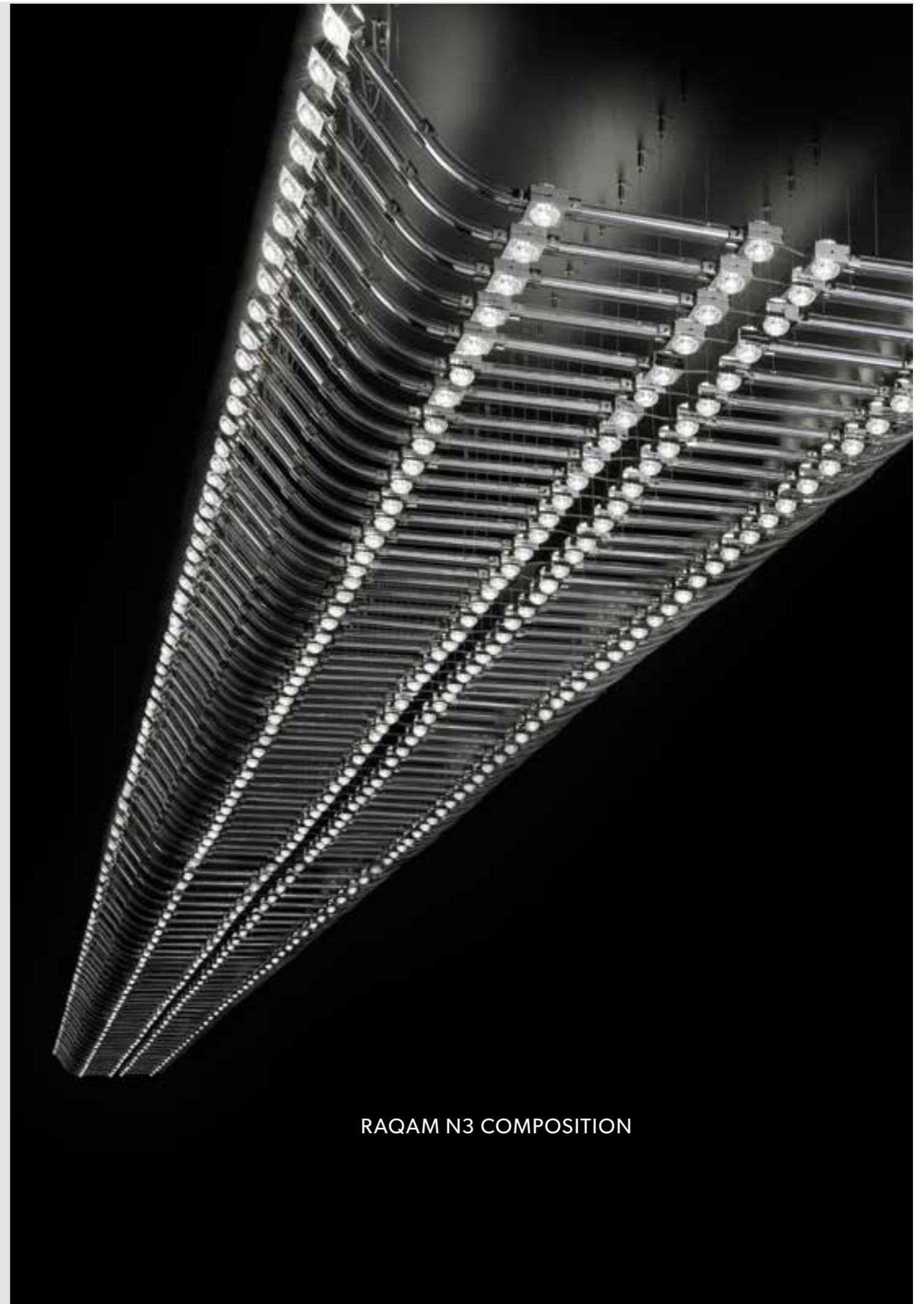
Repeat in length



Front view

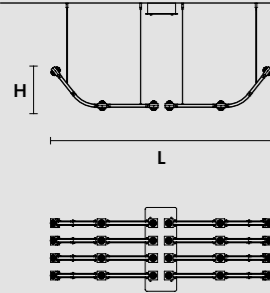


Top view



RAQAM N3 COMPOSITION

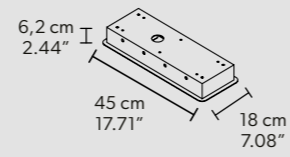
RAQAM N3 BASIC BATCH A - MODULO 5 X 8



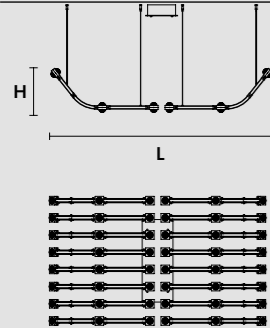
L 125 x 35 cm / 49.21" x 13.77"
H 25 cm / 9.84"
W 15 kg / 33.06 lb

48 LED LIGHTS CRI > 80
 3000 K - 72 W - 9360 Nominal Lumen
 Dimmable PUSH or DMX on request.

Fixing: 1 x canopy
 16 x single steel cables.
 The canopy contains:
 1 x driver
 1 x control board



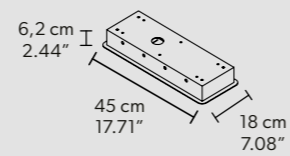
RAQAM N3 BASIC BATCH B - MODULO 5 X 16



L 125 x 75 cm / 49.21" x 29.52"
H 25 cm / 9.84"
W 25 kg / 55.11 lb

96 LED LIGHTS CRI > 80
 3000 K - 144 W - 18720 Nominal Lumen
 Dimmable PUSH or DMX on request.

Fixing: 1 x canopy
 32 x single steel cables.
 The canopy contains:
 1 x driver
 1 x control board

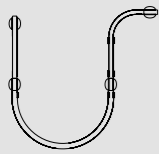


RAQAM N3 COMPOSITION

N4 CONCEPT

Linear arrangement

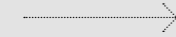
MODULES



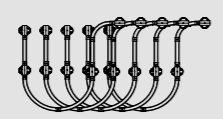
MODULE 4

REPEAT IN LENGTH

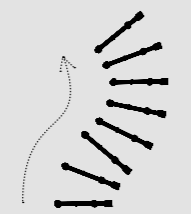
MODULE 4 X 8



Repeat along a curved line



Front view

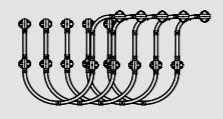


Top view

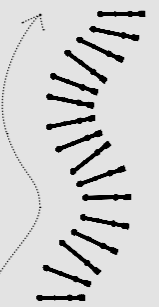
MODULE 4 X 16



Repeat along a curved line

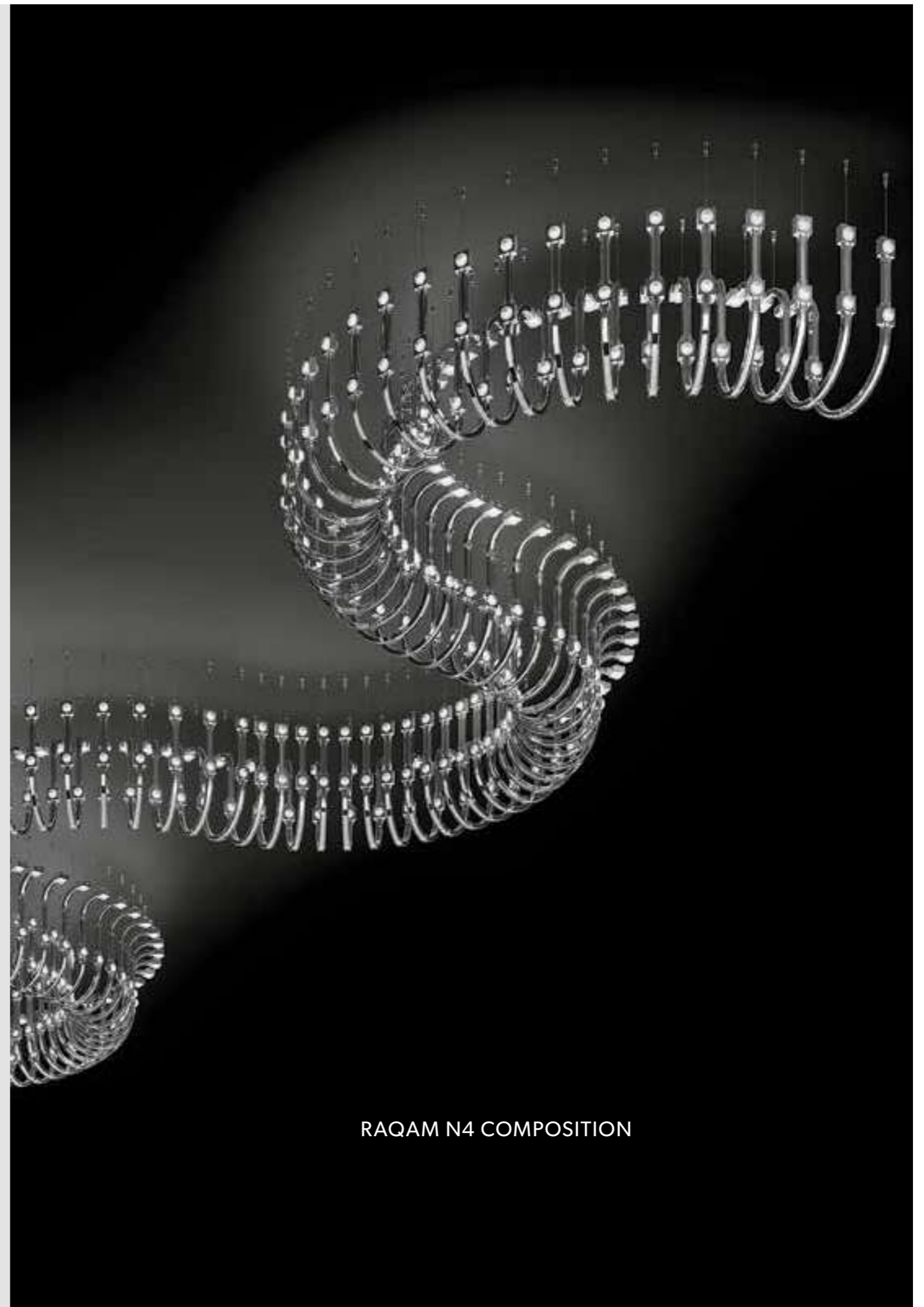
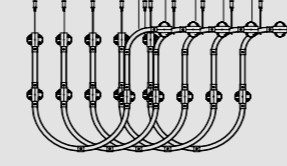
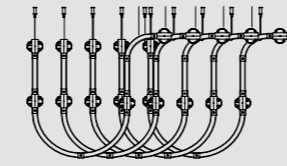


Front view



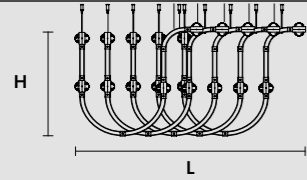
Top view

COMPOSITION



RAQAM N4 COMPOSITION

RAQAM N4 BASIC BATCH A - MODULO 4 X 8



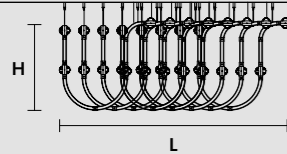
L 90 x 145 cm / 35.43"x 57.08"
 H 48 cm / 18.89"
 W 14 kg / 30.86 lb

64 LED LIGHTS CRI > 80
 3000 K - 96 W - 12480 Nominal Lumen
 Dimmable PUSH or DMX on request.

Fixing:
 16 x single steel cables.
 8 x main power supply
 (1 driver + 1 control board recessed)



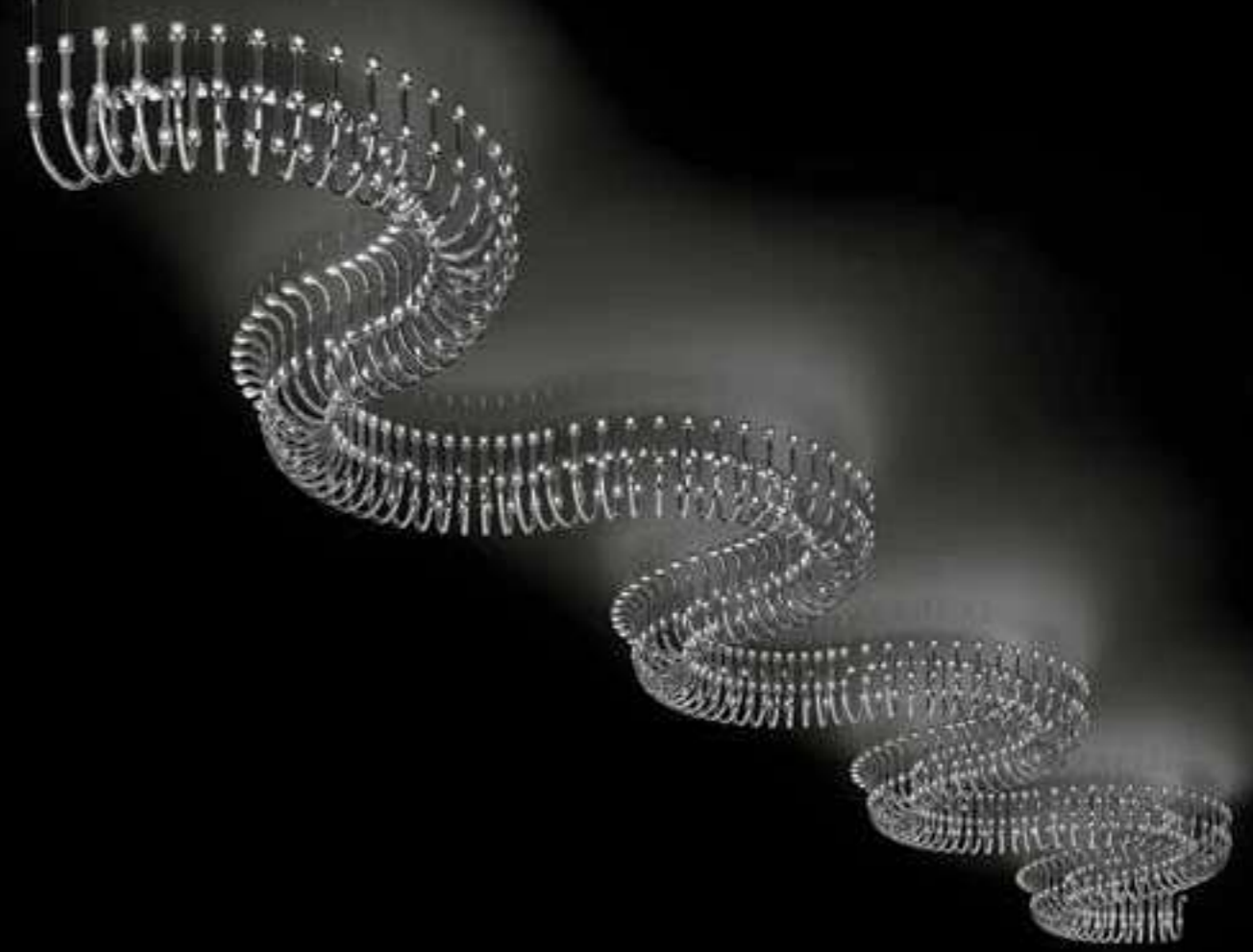
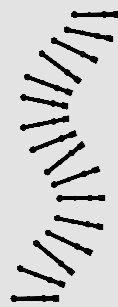
RAQAM N4 BASIC BATCH B - MODULO 4 X 16



L 100 x 305 cm / 39.37"x 118.89"
 H 48 cm / 18.89"
 W 26 kg / 57.32 lb

128 LED LIGHTS CRI > 80
 3000 K - 192 W - 24960 Nominal Lumen
 Dimmable PUSH or DMX on request.

Fixing:
 32 x single steel cables.
 16 x main power supply
 (1 driver + 1 control board recessed)

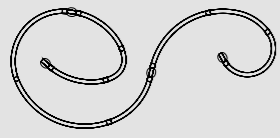


RAQAM N4 COMPOSITION

N5_N6 CONCEPT

Area arrangement

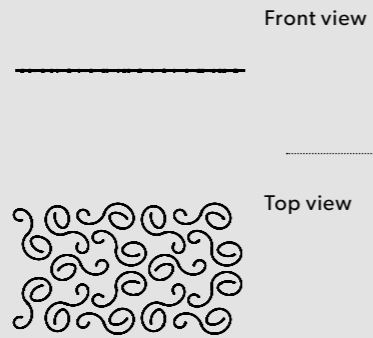
MODULES



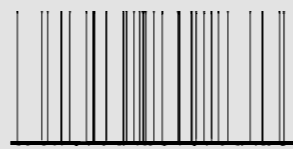
MODULE 1

HORIZONTAL ARRANGEMENT

MODULE 1 X 16

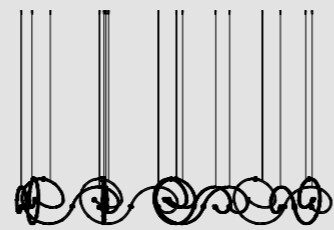
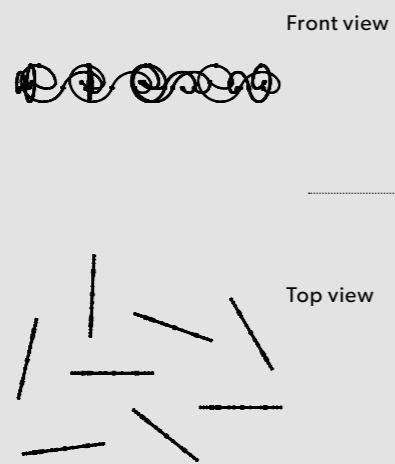


COMPOSITION



VERTICAL ARRANGEMENT

MODULE 1 X 8



RAQAM MODULE 1

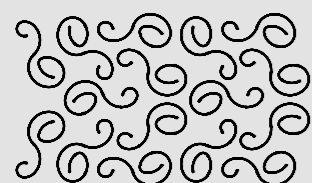
RAQAM N5 BASIC BATCH A - MODULO 1 X 16



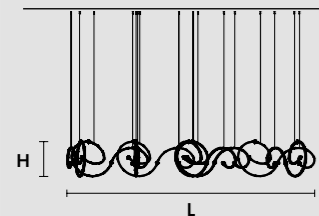
L 450 x 260 cm / 177.16" x 102.36"
 H 5 cm / 1.96"
 W 52 kg / 114.64 lb

128 LED LIGHTS CRI > 80
 3000 K - 192 W - 24960 Nominal Lumen
 Dimmable PUSH or DMX on request.

Fixing:
 48 x single steel cables.
 16 x main power supply
 (1 driver + 1 control board recessed)



RAQAM N6 BASIC BATCH A - MODULO 1 X 8



L 369 x 290 cm / 145.27" x 114.17"
 H 57 cm / 22.44"
 W 27 kg / 59.52 lb

64 LED LIGHTS CRI > 80
 3000 K - 96 W - 12480 Nominal Lumen
 Dimmable PUSH or DMX on request.

Fixing:
 16 x single steel cables.
 8 x main power supply
 (1 driver + 1 control board recessed)



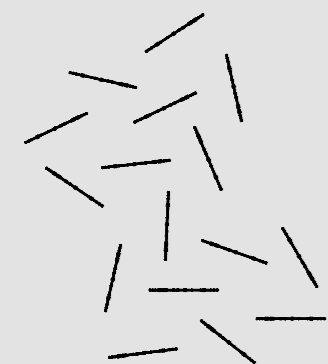
RAQAM N6 BASIC BATCH B - MODULO 1 X 16



L 500 x 580 cm / 196.85" x 228.34"
 H 57 cm / 22.44"
 W 52 kg / 114.64 lb

128 LED LIGHTS CRI > 80
 3000 K - 192 W - 24960 Nominal Lumen
 Dimmable PUSH or DMX on request.

Fixing:
 32 x single steel cables.
 16 x main power supply
 (1 driver + 1 control board recessed)



RAQAM N6 COMPOSITION

N7 CONCEPT Area arrangement

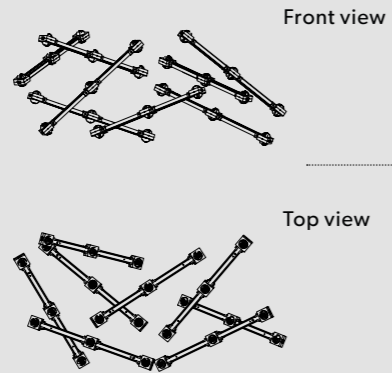
MODULES



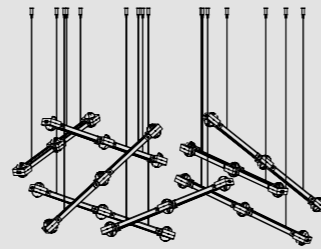
MODULE 7

INCLINED ARRANGEMENT

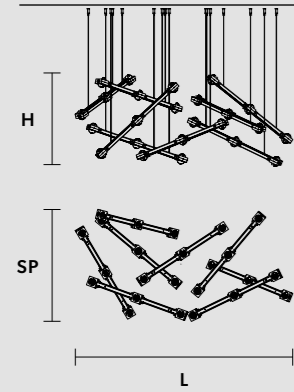
MODULE 7 X 8



COMPOSITION



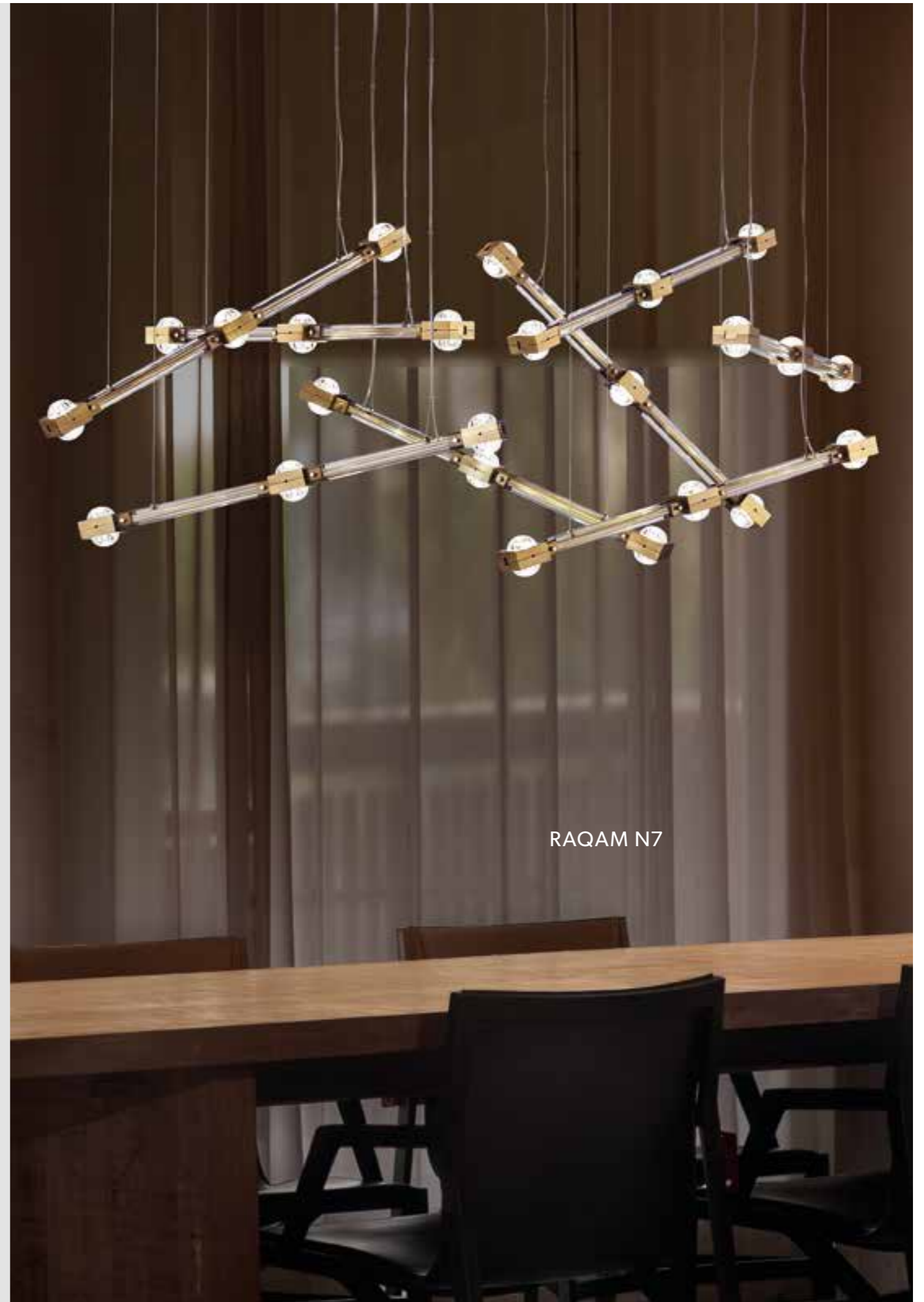
RAQAM N7

RAQAM N7 BASIC BATCH A - MODULO 7 X 8

L 117 cm / 46.06"
 SP 60 cm / 23.62"
 H 50 cm / 19.68"
 W 12 kg / 26.45 lb

48 LED x 72W CRI>80 3000 K -
 9360 Nominal Lumen
 DIMMABLE: PUSH + DMX on request.

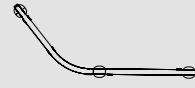
Fixing:
 16 x single steel cables.
 8 x main power supply
 (1 driver + 1 control
 board recessed)



RAQAM N7

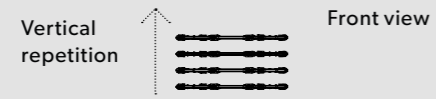
O1_P3 CONCEPT Vertical arrangement

MODULES

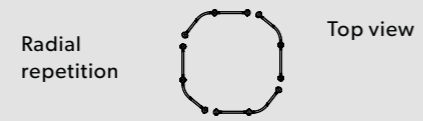


MODULE 5

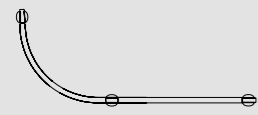
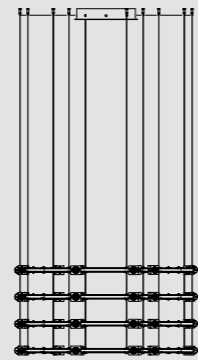
RADIAL / VERTICAL REPETITION



MODULE 5 X 16

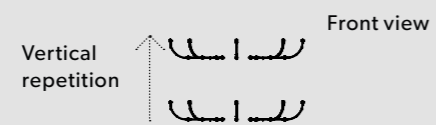


COMPOSITION

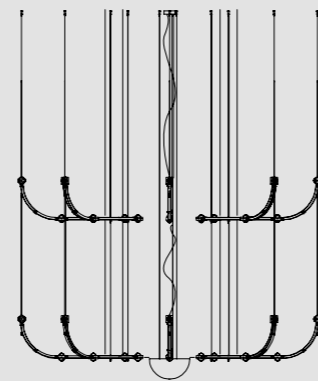
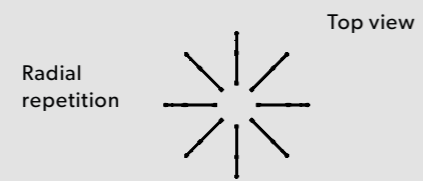


MODULE 3

RADIAL / VERTICAL REPETITION

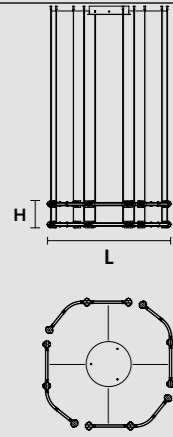


MODULE 3 X 16



RAQAM P3 COMPOSITION

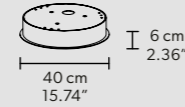
RAQAM O1 BASIC BATCH A - MODULO 5 X 8



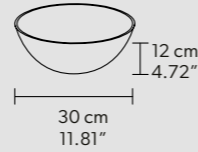
L 93,5 x 93,5 cm / 36,81 x 36,81"
 H 20 cm / 7.87"
 W 16 kg / 35.27 lb

48 LED LIGHTS CRI > 80
 3000 K - 72 W - 9360 Nominal Lumen
 Dimmable PUSH or DMX on request.

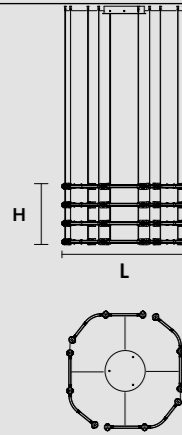
Fixing: 1 x canopy
 12 x single steel cables.
 The canopy contains:
 1 x driver
 1 x control board



Any additional element requires one additional cup with driver and control board.



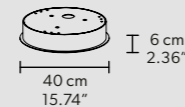
RAQAM O1 BASIC BATCH B - MODULO 5 X 16



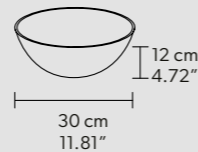
L 93,5 x 93,5 cm / 36,81 x 36,81"
 H 50 cm / 19.68"
 W 26 kg / 57.32 lb

96 LED LIGHTS CRI > 80
 3000 K - 144W - 18720- Nominal Lumen
 Dimmable PUSH or DMX on request.

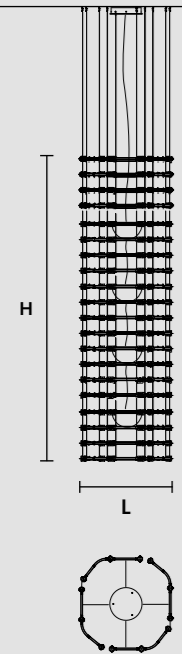
Fixing: 1 x canopy
 12 x single steel cables.
 The canopy contains:
 1 x driver
 1 x control board



Any additional element requires one additional cup with driver and control board.



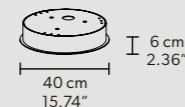
RAQAM O1 COMPOSITION - BASIC BATCH B X 5



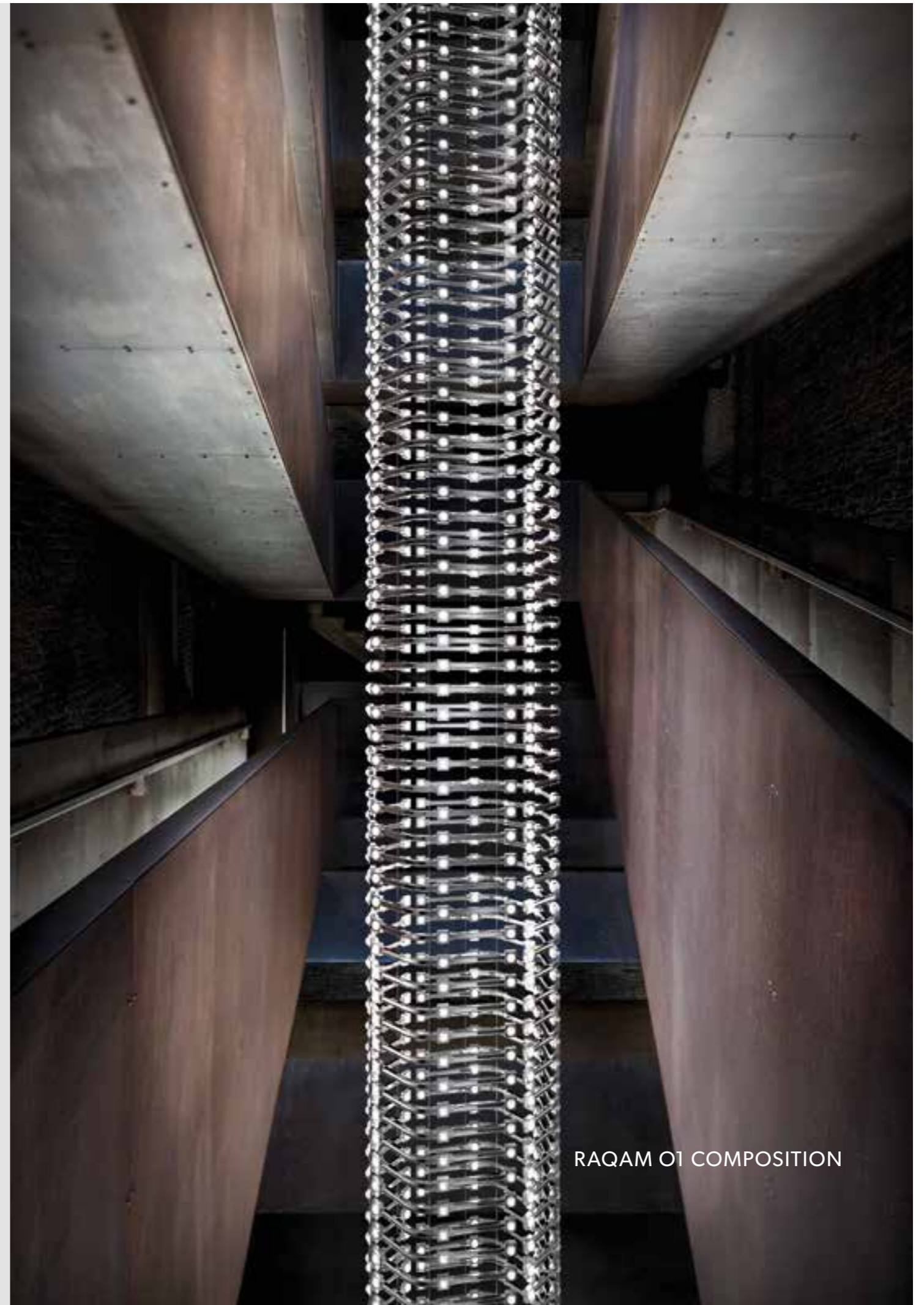
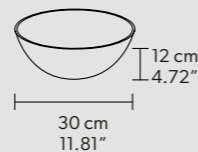
L 93,5 x 93,5 cm / 36,81 x 36,81"
 H 250 cm / 98.42"
 W 135 kg / 297.62 lb

480 LED LIGHTS CRI > 80
 3000 K - 720W - 93600 Nominal Lumen
 Dimmable PUSH or DMX on request

Fixing: 1 x canopy
 12 x single steel cables.
 The canopy contains:
 1 x driver
 1 x control board

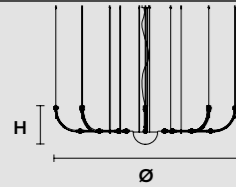


4 cups requires one additional cup with drivers and control boards.



RAQAM O1 COMPOSITION

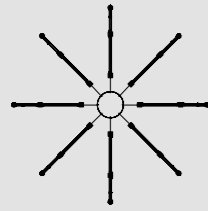
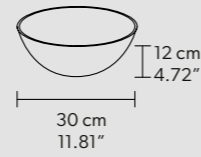
RAQAM P3 BASIC BATCH A - MODULO 3 X 8



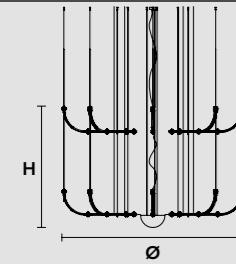
Ø 220 cm / 86.61"
 H 47 cm / 18.50"
 W 17 kg / 37.47 lb

48 LED LIGHTS CRI > 80
 3000 K - 72W- 9360 Nominal Lumen
 Dimmable PUSH or DMX on request.

Fixing: 1 x central bracket
 19 x single steel cables.
 The cup contains:
 1 x driver
 1 x control board



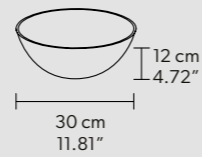
RAQAM P3 BASIC BATCH B - MODULO 3 X 16



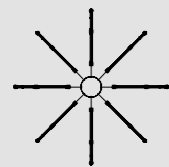
Ø 220 cm / 86.61"
 H 147 cm / 57.87"
 W 26 kg / 57.32 lb

96 LED LIGHTS CRI > 80
 3000 K - 144W-
 18720 Nominal Lumen
 Dimmable PUSH or
 DMX on request..

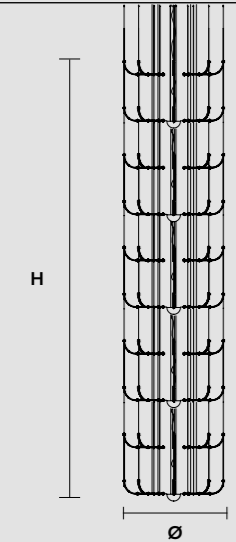
Fixing: 1 x central bracket
 19 x single steel cables.
 The cup contains:
 1 x driver
 1 x control board



Any additional
 element
 requires one
 additional cup
 with driver and
 control board.



RAQAM P3 COMPOSITION - BASIC BATCH B X 5

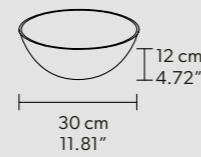


Ø 220 cm / 86.61"
 H 946 cm / 372.44"
 W 135 kg / 297.62 lb

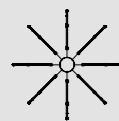
480 LED LIGHTS - CRI > 80
 3000 K - 720W- 93600 Nominal Lumen
 Dimmable PUSH or DMX on request.

Fixing: 1 x central bracket
 19 x single steel cables.

Each cup contains:
 1 x driver
 1 x control board



Any additional element
 requires one additional
 cup with driver and
 control board.

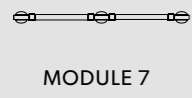


RAQAM P3 COMPOSITION

P4 CONCEPT

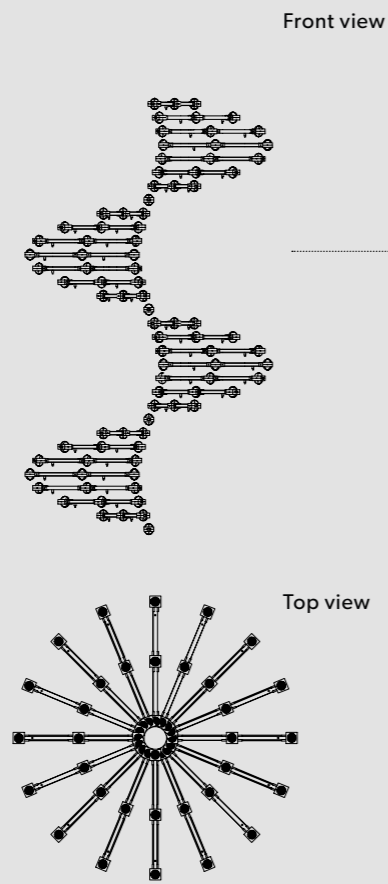
Vertical arrangement

MODULES

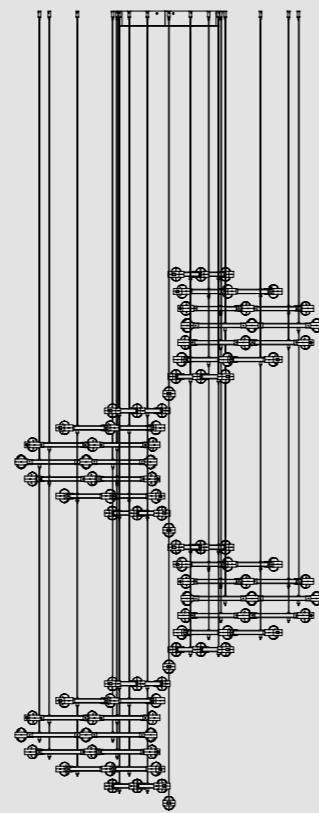


RADIAL / VERTICAL REPETITION

MODULE 7 X 32

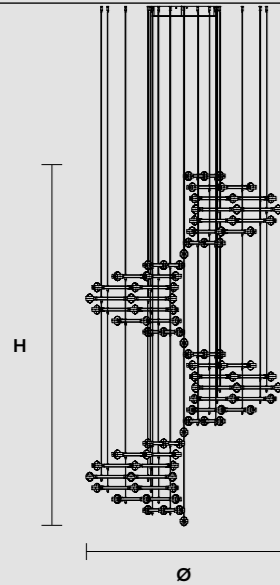


COMPOSITION



RAQAM P4

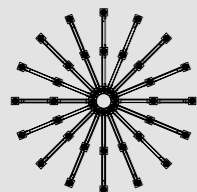
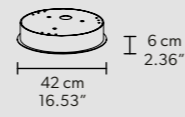
RAQAM P4 BASIC BATCH A - MODULO 7 X 32



Ø 126 cm / 49.60"
 H 223 cm / 87.79"
 W 42 kg / 92.59 lb

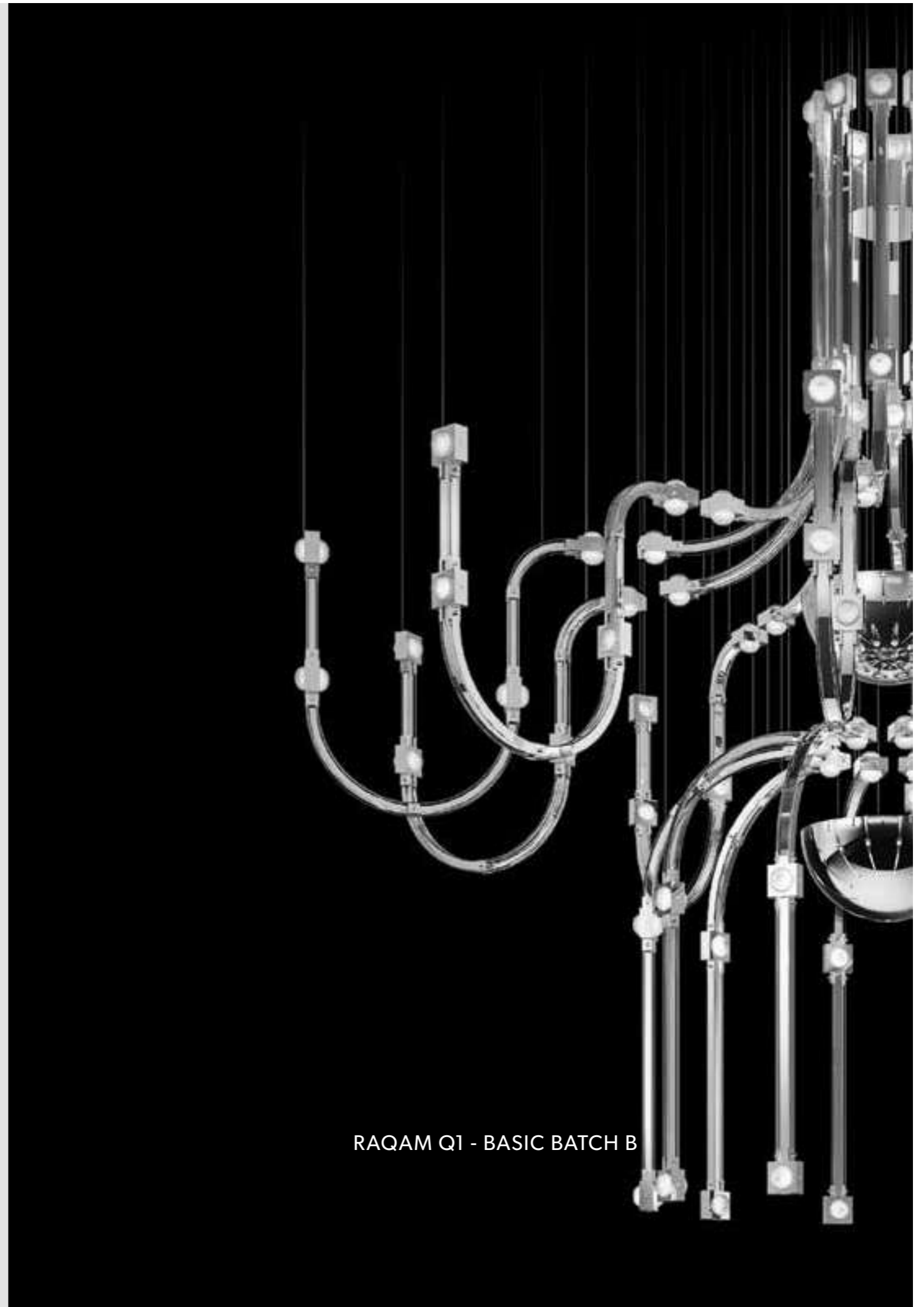
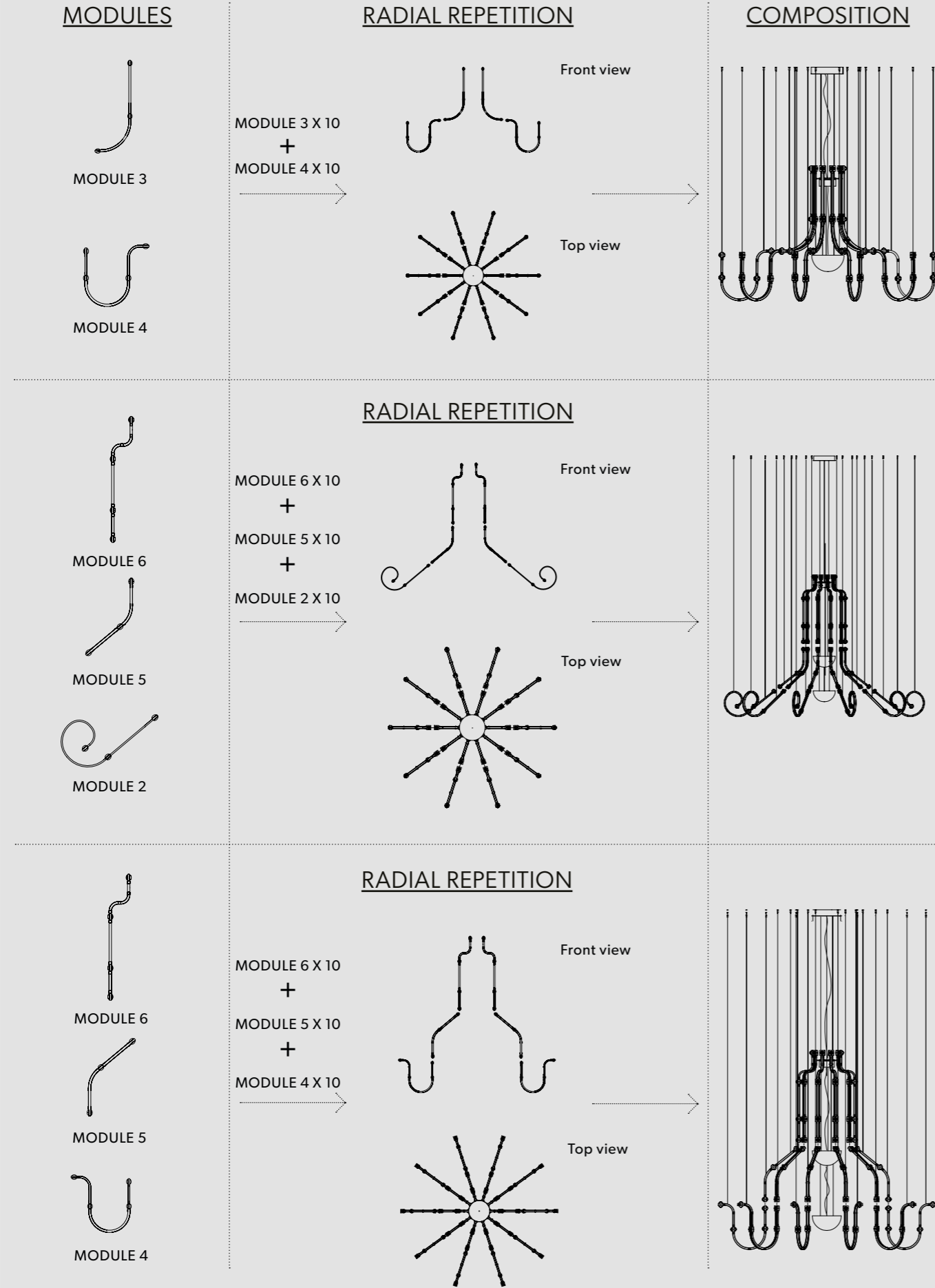
192 LED LIGHTS CRI > 80
 3000 K - 288W- 37440 Nominal Lumen
 Dimmable PUSH or DMX on request.

Fixing: 1 x canopy
 32 x single steel cables.
 The canopy contains:
 2 x drivers
 2 x control boards

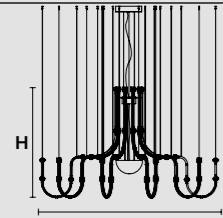


RAQAM P4

Q1_Q3_Q4 CONCEPT Chandelier arrangement



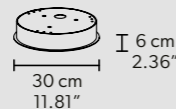
RAQAM Q1 BASIC BATCH A – MODULO 3 X 10 + MODULO 4 X 10



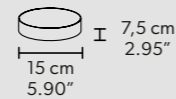
Ø 195cm/76.77"
H 121cm /47.63"
W 45 kg / 99.20 lb

140 LED LIGHTS CRI > 80
3000 K - 210 W- 27300 Nominal Lumen
Dimmable PUSH or DMX on request.

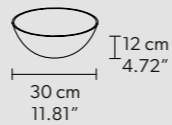
Fixing: 1 x canopy
30 x single steel cables.
The canopy contains:
1 x driver



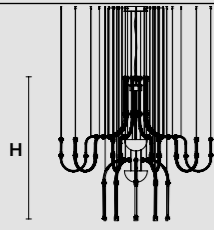
The box contains:
1 x control board



The cup contains:
1 x driver
1 x control board



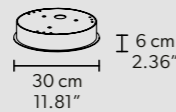
RAQAM Q1 BASIC BATCH B – MODULO 3 X 10 + MODULO 4 X 10 + MODULO 3 X 10



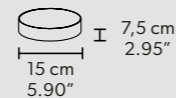
Ø 195 cm / 76.77"
H 173 cm / 68.11"
W 65 kg / 143.3 lb

200 LED LIGHTS CRI > 80
3000 K - 300 W- 39000 Nominal Lumen
Dimmable PUSH or DMX on request.

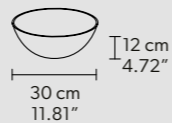
Fixing: 1 x canopy
50 x single steel cables.
The canopy contains:
1 x driver



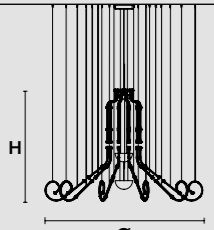
The box contains:
1 x control board



Each cup contains:
1 x drivers
1 x control boards



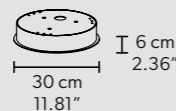
RAQAM Q3 BASIC BATCH A – MODULO 2 X 10 + MODULO 5 X 10 + MODULO 6 X 10



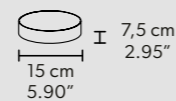
Ø 270 cm / 106.29"
H 192 cm / 75.59"
W 70 kg / 154.32lb

200 LED LIGHTS CRI>80
3000K - 300 W- 39000 Nominal Lumen
Dimmable PUSH or DMX on request.

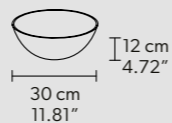
Fixing: 1 x canopy
30 x single steel cables.
The canopy contains:
1 x driver



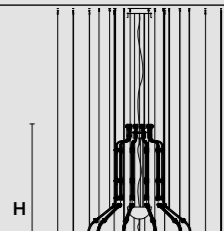
The box contains:
1 x control board



Each cup contains:
1 x drivers
1 x control boards



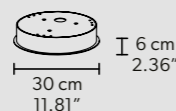
RAQAM Q4 BASIC BATCH A – MODULO 4 X 10 + MODULO 5 X 10 + MODULO 6 X 10



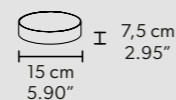
Ø 219 cm / 86.22"
H 200 cm / 78.74"
W 65 kg / 143.3 lb

220 LED LIGHTS CRI>80
3000K - 330 W- 42900 Nominal Lumen
Dimmable PUSH or DMX on request.

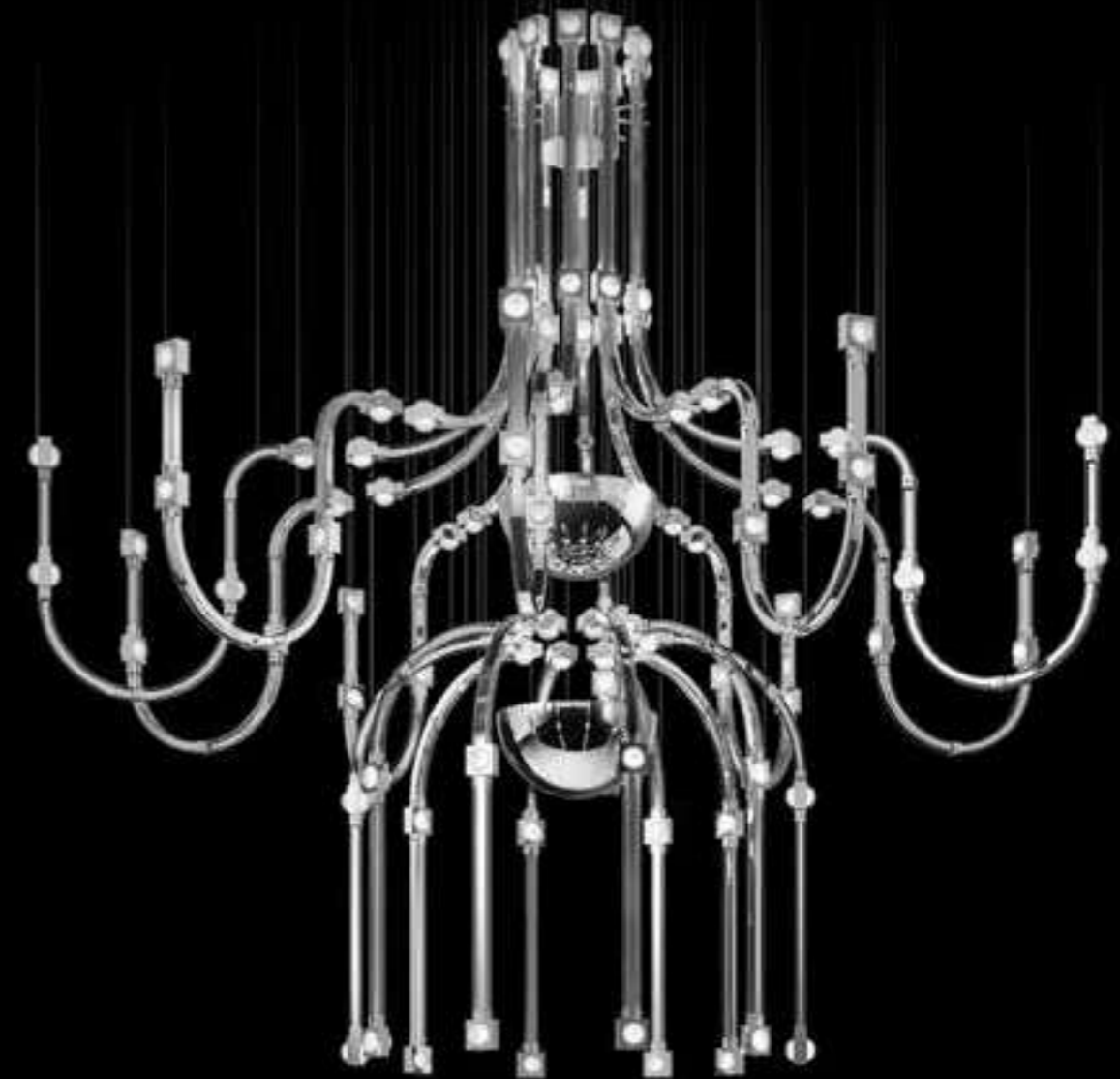
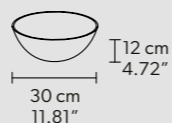
Fixing: 1 x canopy
30 x single steel cables.
The canopy contains:
1 x driver



The box contains:
1 x control board



Each cup contains:
1 x drivers
1 x control boards



RAQAM Q1 - BASIC BATCH B

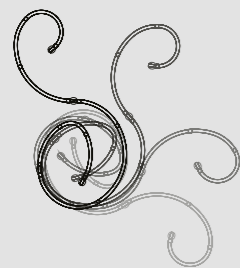
Q5 CONCEPT Chandelier arrangement

MODULES



MODULE 1

*Ruotando il modulo è possibile ottenere composizioni di altezze differenti - è possibile sommare in altezza le diverse composizioni.
/By rotating the Module it is possible to obtain compositions of different heights - the different compositions can be added in height.

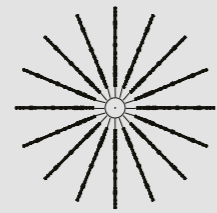


RADIAL / VERTICAL REPETITION

MODULE 1 X 16



Front view

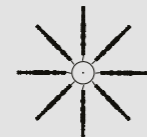


Top view

MODULE 1 X 8



Front view

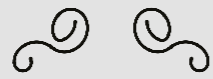


Top view

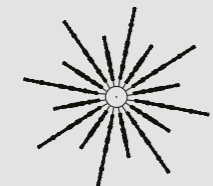
MODULE 1 X 8

+

MODULE 1 X 8



Front view

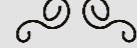


Top view

MODULE 1 X 8

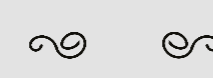
+

MODULE 1 X 8

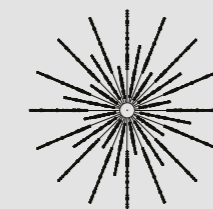


+

MODULE 1 X 16

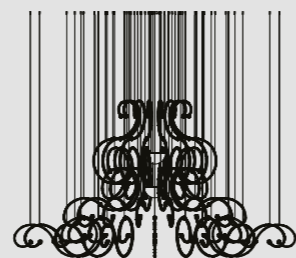
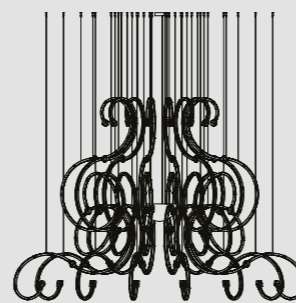
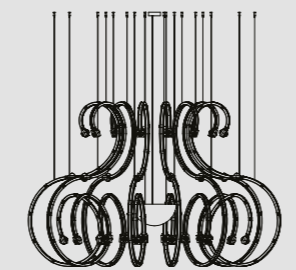
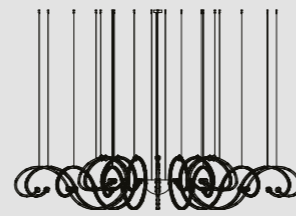


Front view



Top view

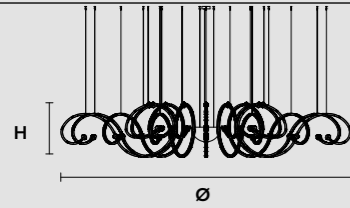
COMPOSITION



RAQAM Q5 - BASIC BATCH D

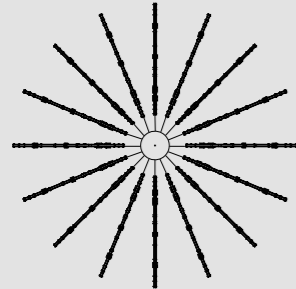


RAQAM Q5 BASIC BATCH A - MODULE 1 X 16

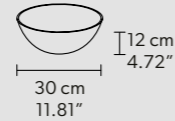


Ø 291 cm / 114.56"
 H 55 cm / 21.65"
 W 60 kg / 132.28 lb

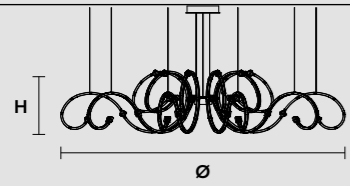
128 LED LIGHTS CRI>80
 3000K - 192 W - 24960 Nominal Lumen
 Dimmable PUSH or DMX on request.



Fixing: 1 x central bracket
 35 x single steel cables.
 The cup contains:
 1 x driver
 1 x control board

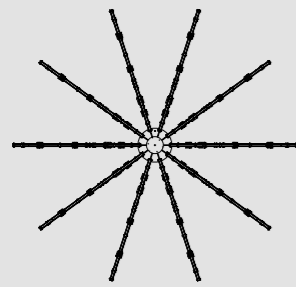


RAQAM Q5 BASIC BATCH E - MODULE 1 X 10

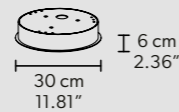


Ø 266 cm / 104.72"
 H 55 cm / 21.65"
 W 38 kg / 83.77 lb

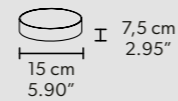
80 LED LIGHTS CRI>80
 3000 K - 120 W - 15600 Nominal Lumen
 DIMMABLE: PUSH + DMX on request.



Fixing: 1 x canopy
 10 x single steel cables.
 The canopy contains:
 1 x driver
 1 x control board

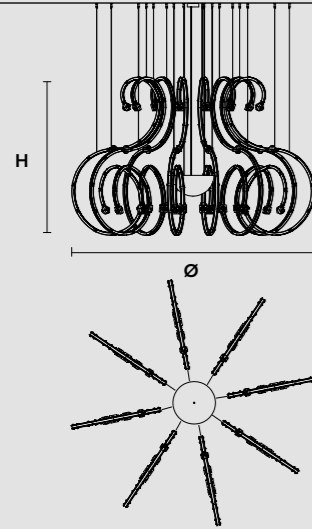


The box contains:
 1 x control board



RAQAM Q5 - BASIC BACH E

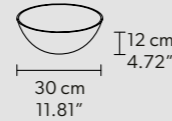
RAQAM Q5 BASIC BATCH B – MODULE 1 X 8



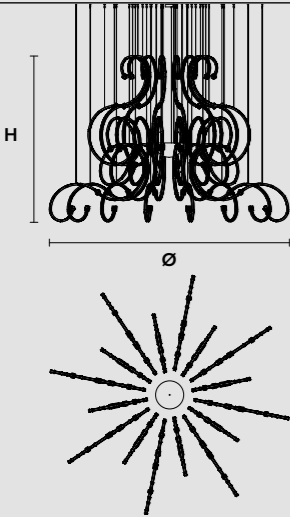
Ø 170 cm / 66.92"
 H 112 cm / 44.09"
 W 32 kg / 70.54 lb

64 LED LIGHTS CRI>80
 3000K - 96W- 12480 Nominal Lumen
 Dimmable PUSH or DMX on request.

Fixing: 1 x central bracket
 19 x single steel cables.
 The cup contains:
 1 x driver
 1 x control board



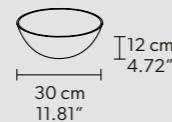
RAQAM Q5 BASIC BATCH C – MODULE 1 X 8 + MODULE 1 X 8



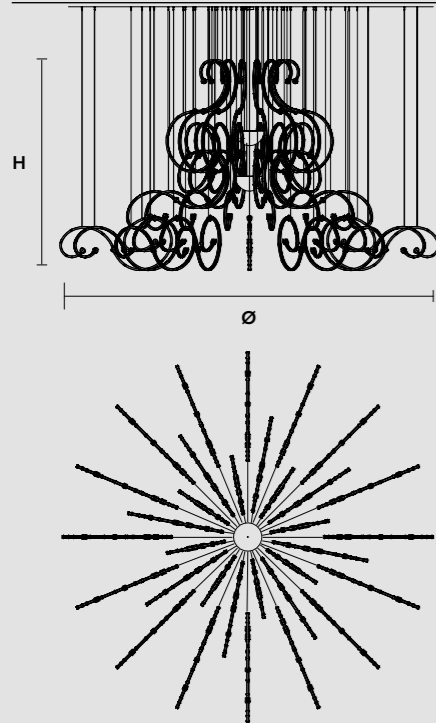
Ø 250 cm / 98.42"
 H 170 cm / 66.92"
 W 60 kg / 132.28 lb

128 LED LIGHTS CRI>80
 3000K - 192 W- 24960 Nominal Lumen
 Dimmable PUSH or DMX on request.

Fixing: 1 x central bracket
 35 x single steel cables.
 The cup contains:
 1 x driver
 1 x control board



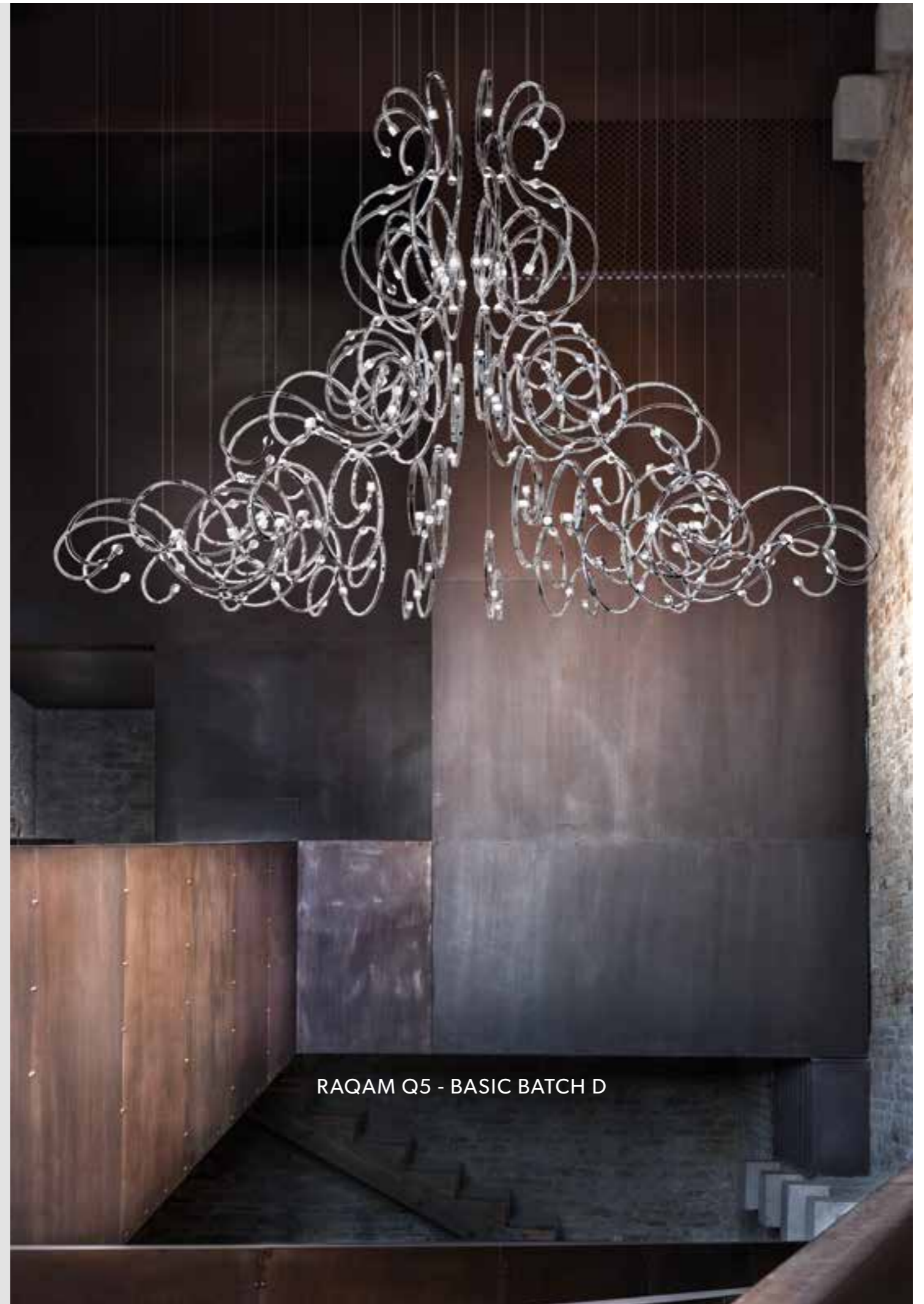
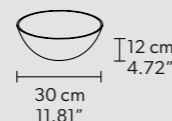
RAQAM Q5 BASIC BATCH D – MODULE 1 X 16 + MODULE 1 X 8 + MODULE 1 X 8



Ø 385 cm / 151.57"
 H 209 cm / 82.28"
 W 120 kg / 264.55 lb

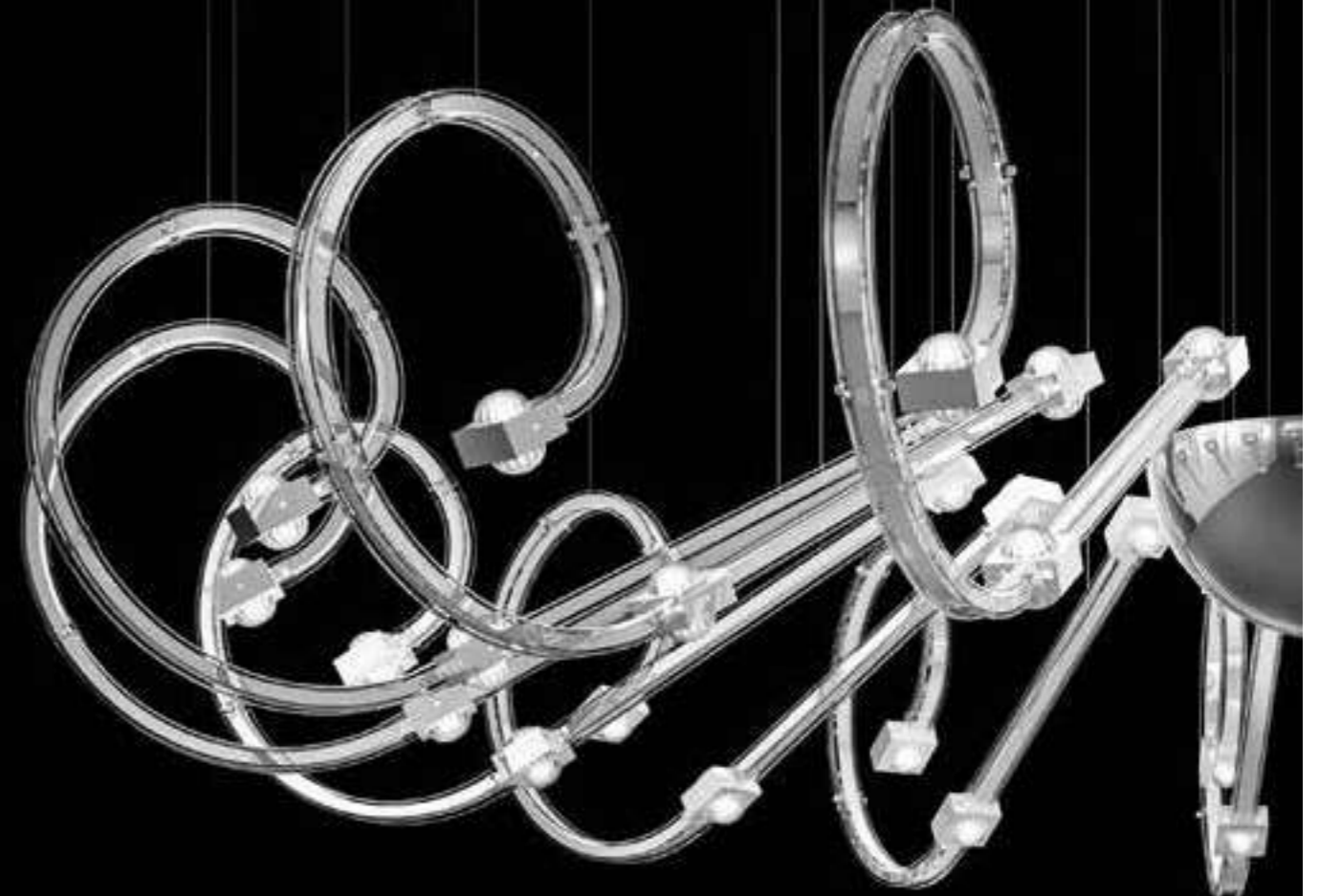
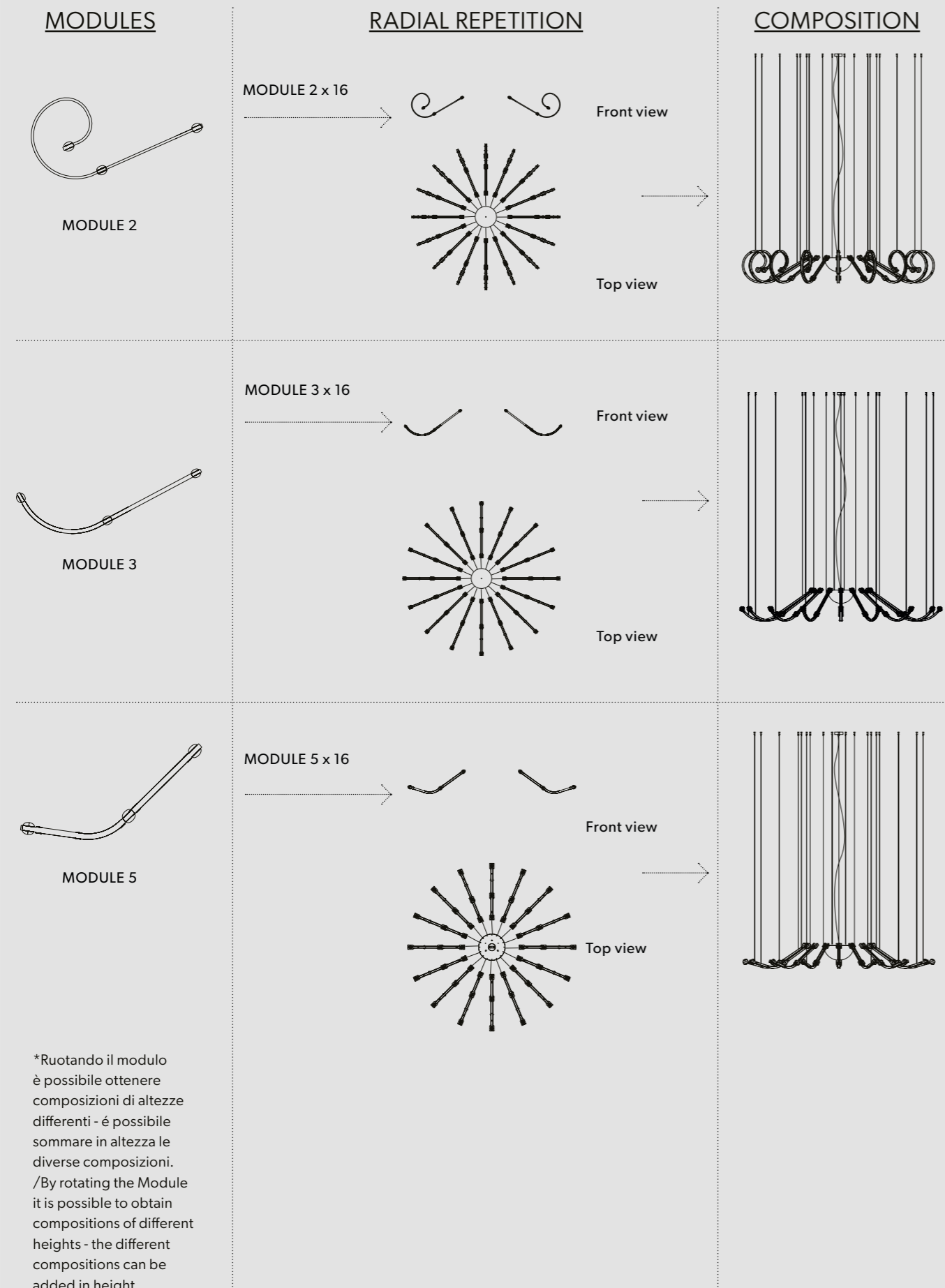
256 LED LIGHTS CRI>80
 3000K - 384 W- 49920 Nominal Lumen
 Dimmable PUSH or DMX on request.

Fixing: 1 x central bracket
 67 x single steel cables.
 Each cup contains:
 1 x driver
 1 x control board



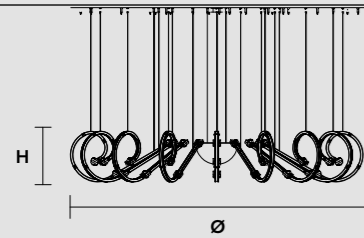
RAQAM Q5 - BASIC BATCH D

Q6_Q7_Q8 CONCEPT Chandelier arrangement



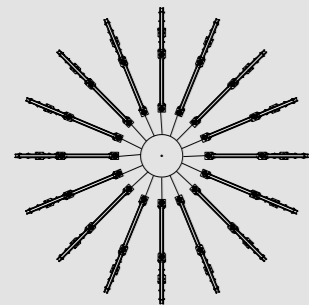
RAQAM Q6

RAQAM Q6 BASIC BATCH A – MODULE 2 X 16

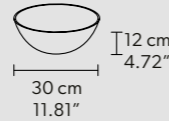


Ø 204 cm / 80.31"
 H 35 cm / 13.77"
 W 40 kg / 88.18 lb

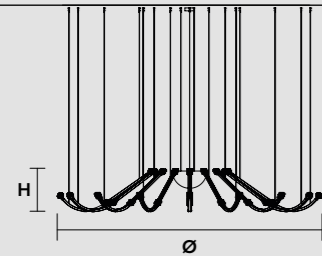
96 LED LIGHTS CRI>80
 3000K - 144 W- 18720 Nominal Lumen
 Dimmable PUSH or DMX on request.



Fixing: 1 x central bracket
 35 x single steel cables.
 The cup contains:
 1 x driver
 1 x control board

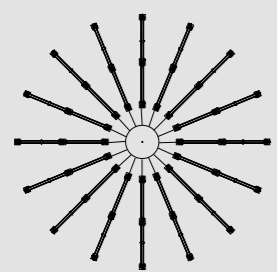


RAQAM Q7 BASIC BATCH A – MODULE 3 X 16

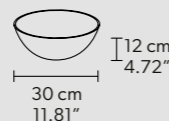


Ø 225 cm / 88.58"
 H 37 cm / 14.56"
 W 26 kg / 57.32 lb

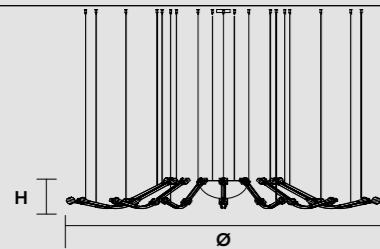
96 LED LIGHTS CRI>80
 3000K - 144 W- 18720 Nominal Lumen
 Dimmable PUSH or DMX on request.



Fixing: 1 x central bracket
 35 x single steel cables.
 The cup contains:
 1 x driver
 1 x control board

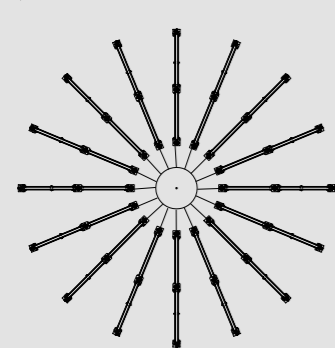


RAQAM Q8 BASIC BATCH A – MODULE 5 X 16

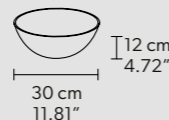


Ø 185 cm / 72.83"
 H 26 cm / 10.23"
 W 26 kg / 57.32 lb

96 LED LIGHTS CRI>80
 3000K - 144 W- 18720 Nominal Lumen
 Dimmable PUSH or DMX on request.



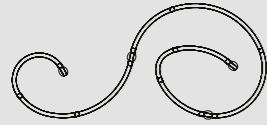
Fixing: 1 x central bracket
 35 x single steel cables.
 The cup contains:
 1 x driver
 1 x control board



RAQAM Q6

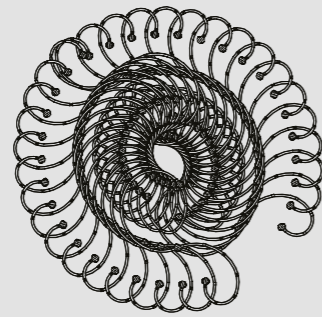
R1 CONCEPT Linear arrangement

MODULES



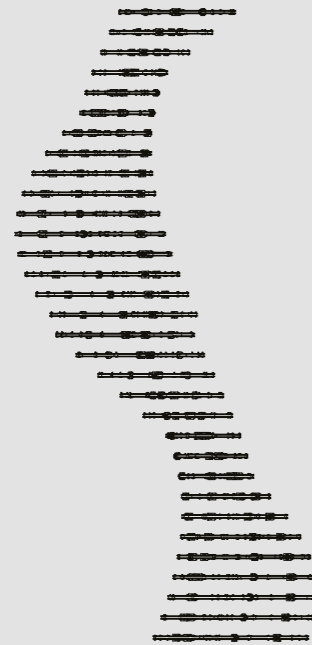
MODULE 1

RADIAL AND LENGTH REPETITION



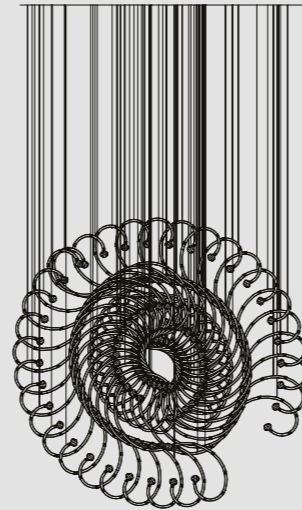
Front view

MODULE 1 X 32

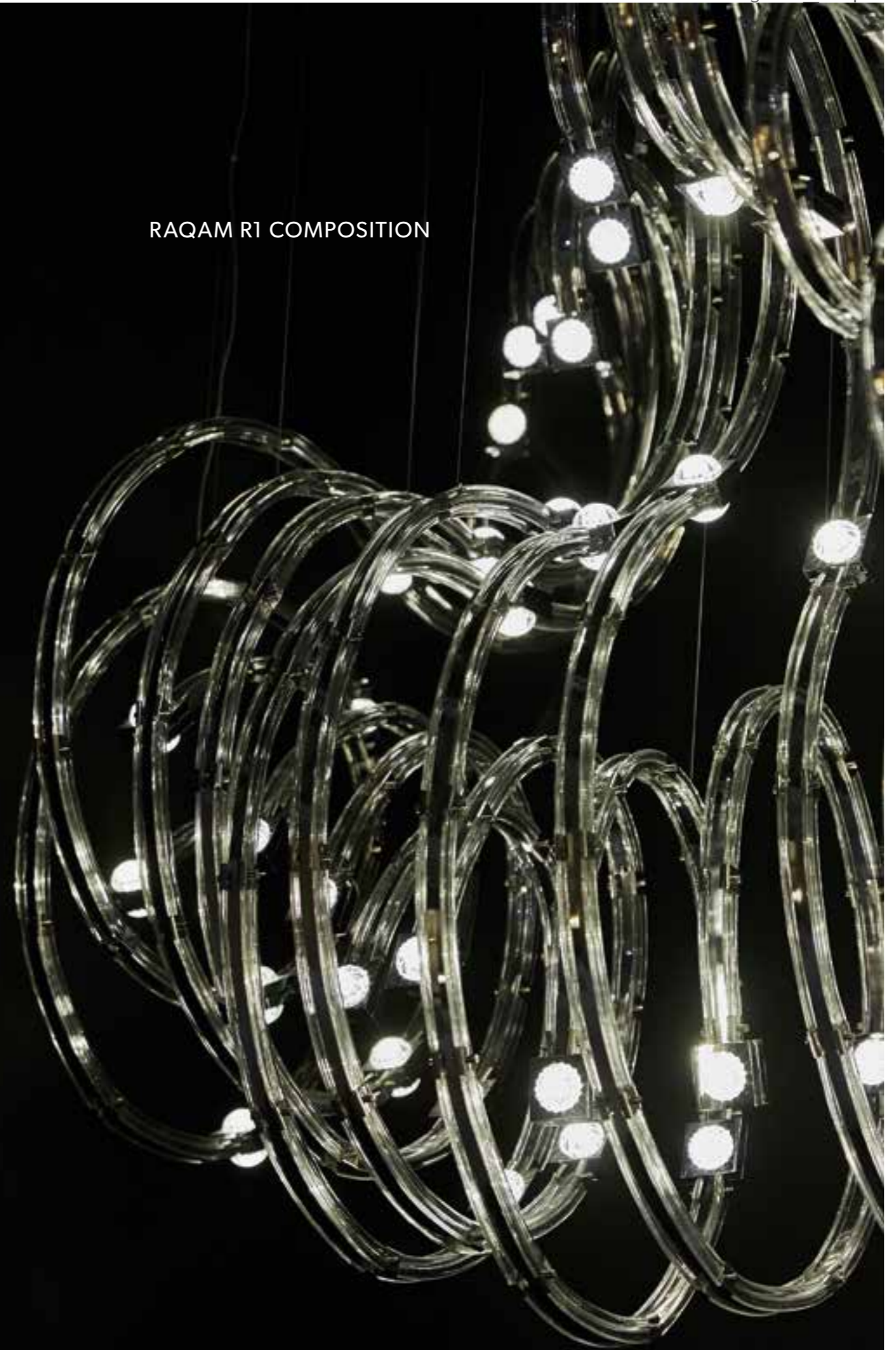


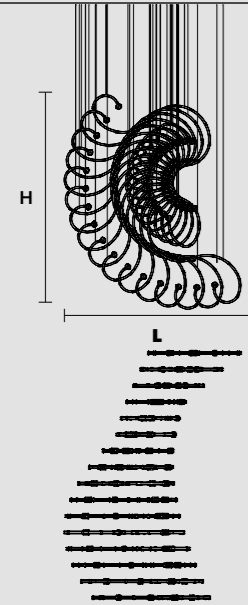
Top view

COMPOSITION



RAQAM R1 COMPOSITION

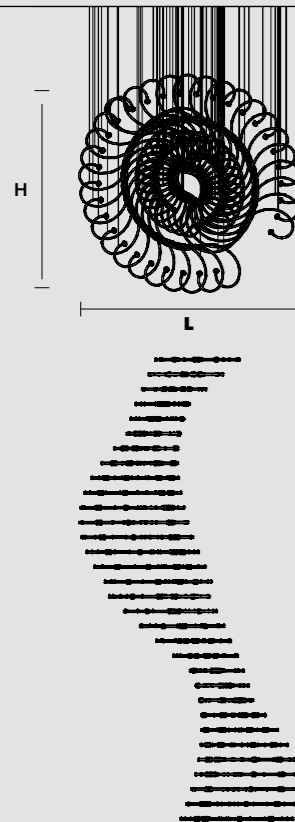


RAQAM R1 BASIC BATCH A – MODULO 1 X 16

L 163 x 230 cm / 64.17" x 90.55"
 H 200 cm / 78.74"
 W 52 kg / 114.64 lb

128 LED LIGHTS CRI>80
 3000K - 192 W- 24960 Nominal Lumen
 Dimmable PUSH or DMX on request

Fixing:
 32 x single steel cables.
 16 x main power supply
 (1 x driver + 1 x control board recessed)

RAQAM R1 BASIC BATCH B – MODULO 1 x 32

L 227 x 470 cm / 89.37 x 185.03"
 H 223 cm / 87.79"
 W 104 kg / 229.28 lb

256 LED LIGHTS CRI>80
 3000K - 384 W- 49920 Nominal Lumen
 Dimmable PUSH or DMX on request.

Fixing:
 64 x single steel cables.
 32 x main power supply
 (2 x drivers + 2 x control boards recessed)



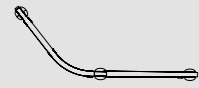
RAQAM R1 COMPOSITION



RAQAM R1 COMPOSITION

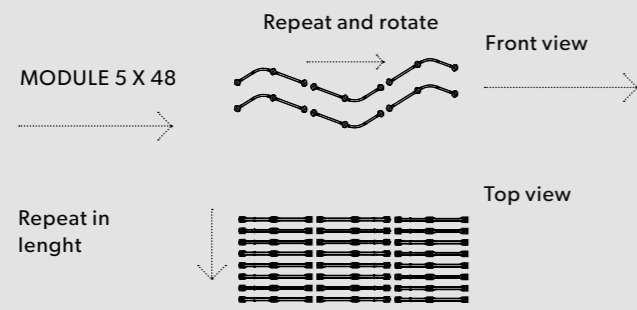
R2 CONCEPT Linear arrangement

MODULES

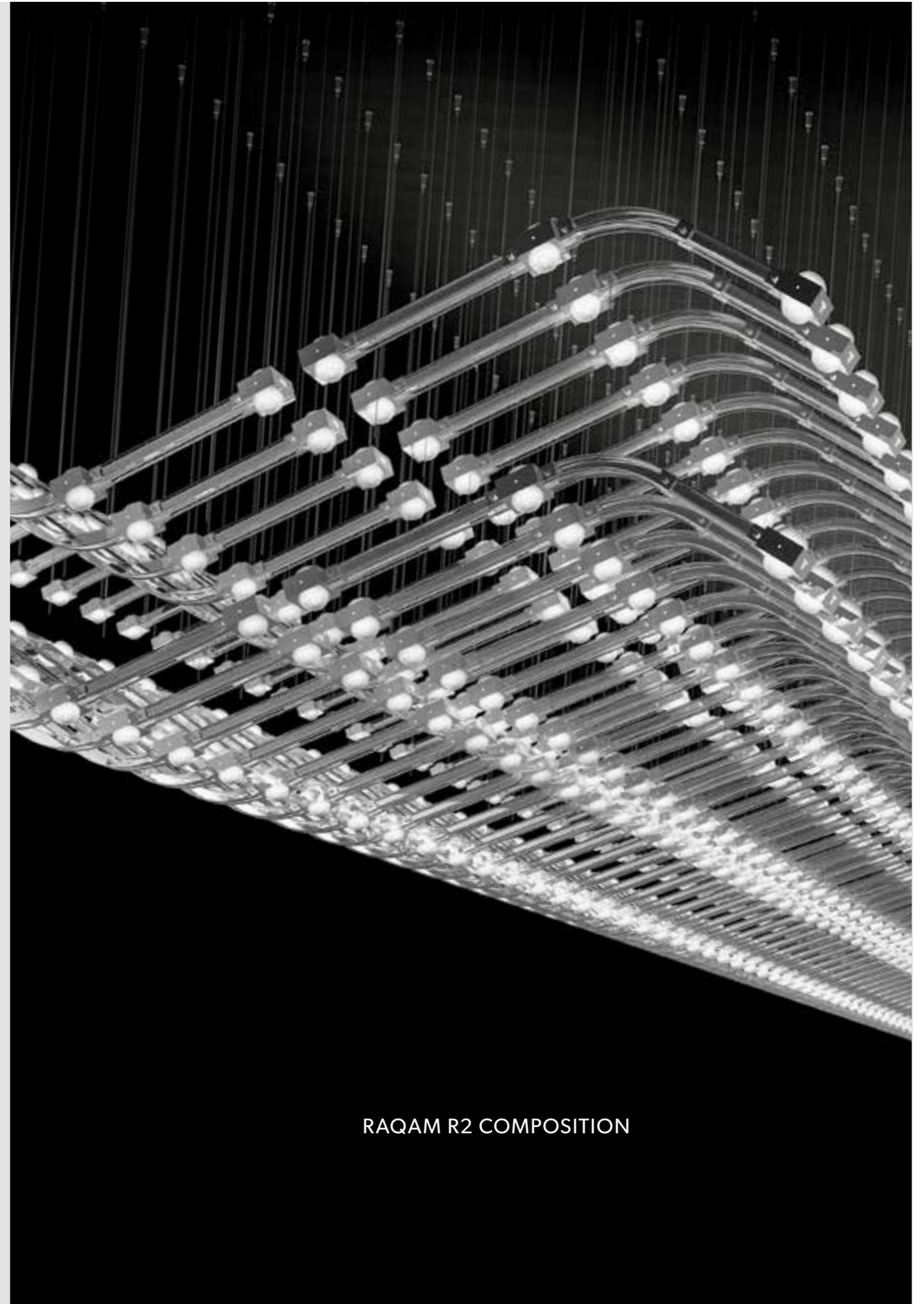
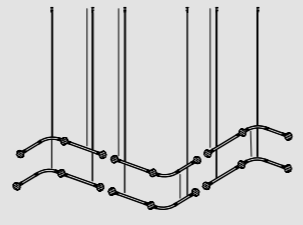


MODULE 5

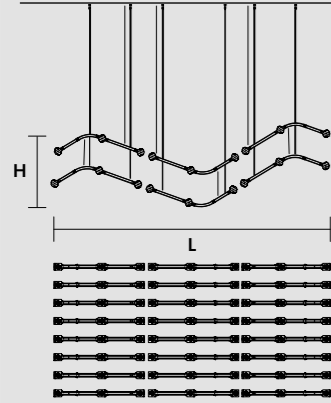
REPETITION IN LENGTH AND WIDTH



COMPOSITION



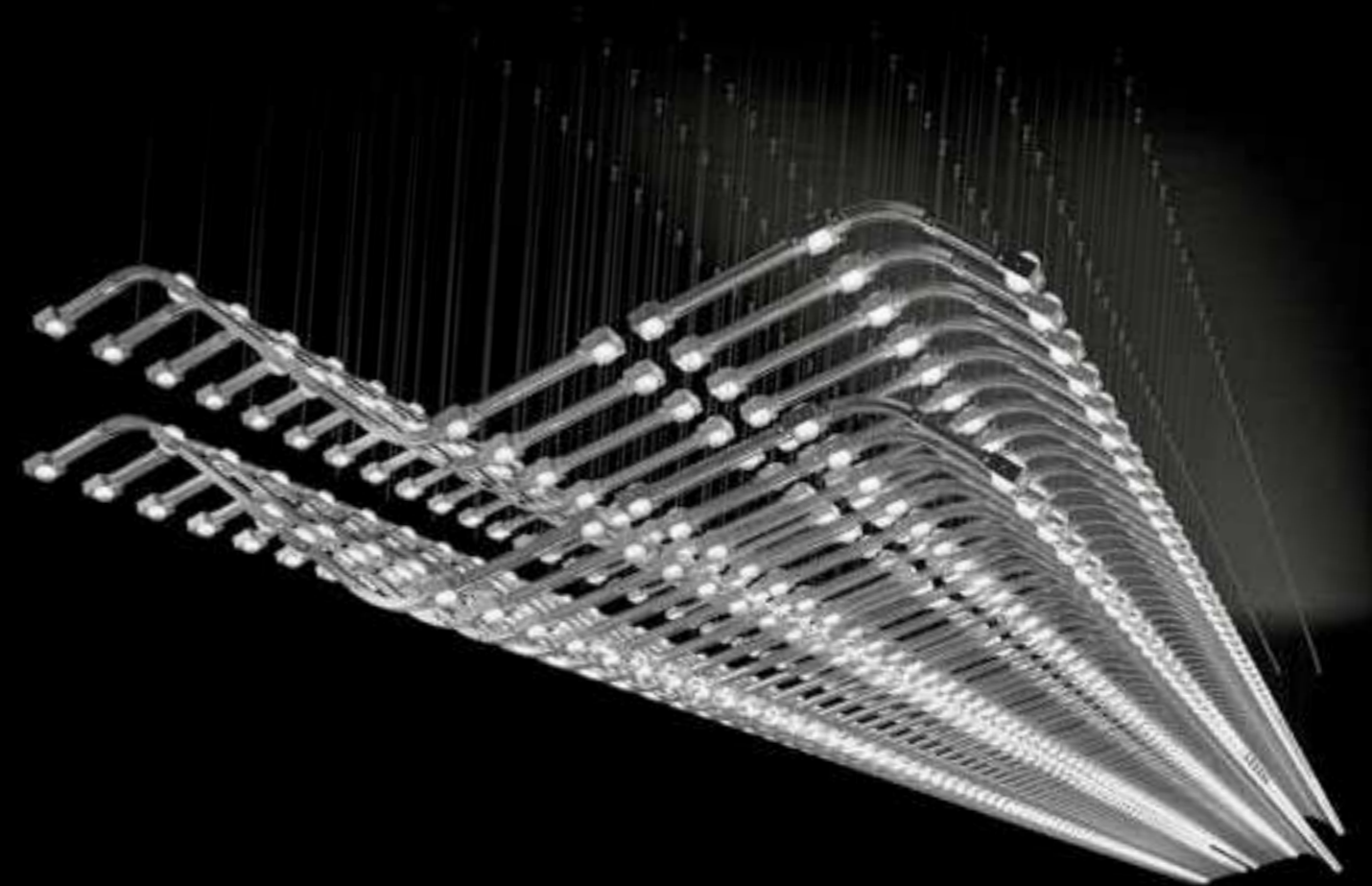
RAQAM R2 COMPOSITION

RAQAM R2 BASIC BATCH B - MODULO 5 X 48

L 200 x 96cm / 78.74"x 37.79"
 H 60 cm / 23.62"
 W 62 kg / 136.68 lb

288 LED LIGHTS CRI>80
 3000K - 432 W - 56160 Nominal
 Lumen
 Dimmable PUSH or DMX on request.

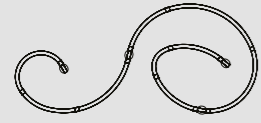
Fixing:
 48 x single steel cables.
 24 x main power supply
 (3 x drivers + 3 x control
 boards recessed)



RAQAM R2 COMPOSITION

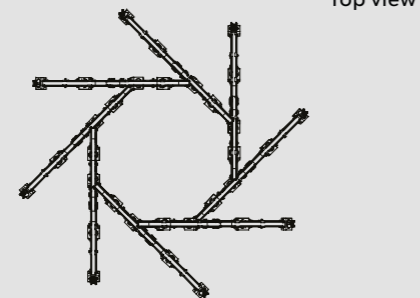
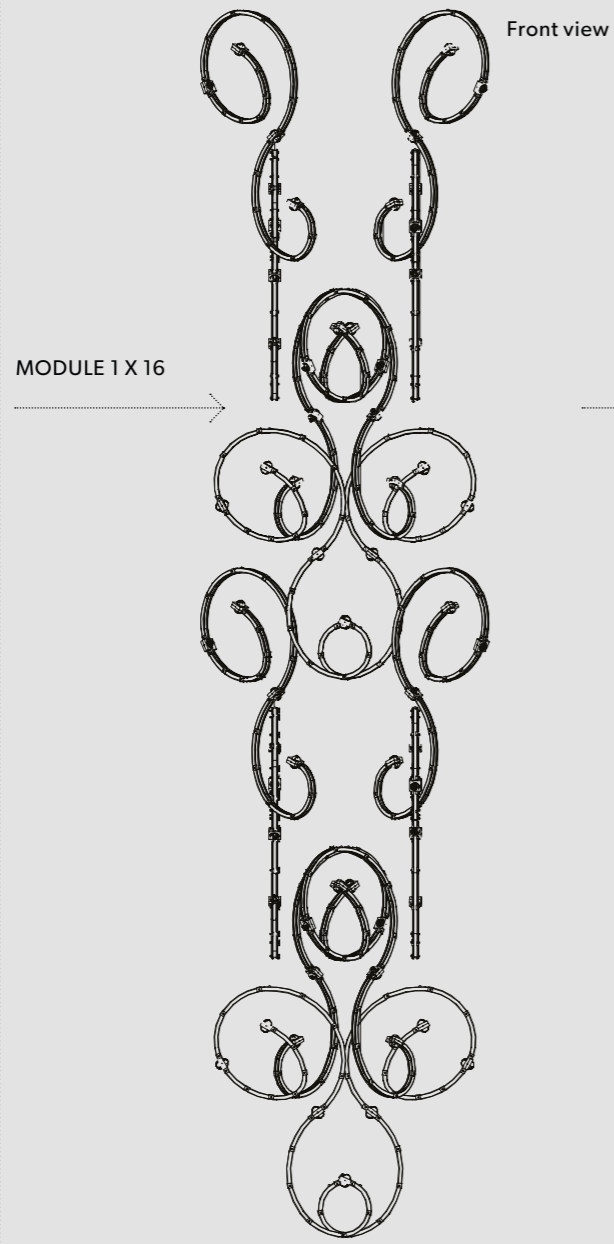
R3 CONCEPT Vertical arrangement

MODULES

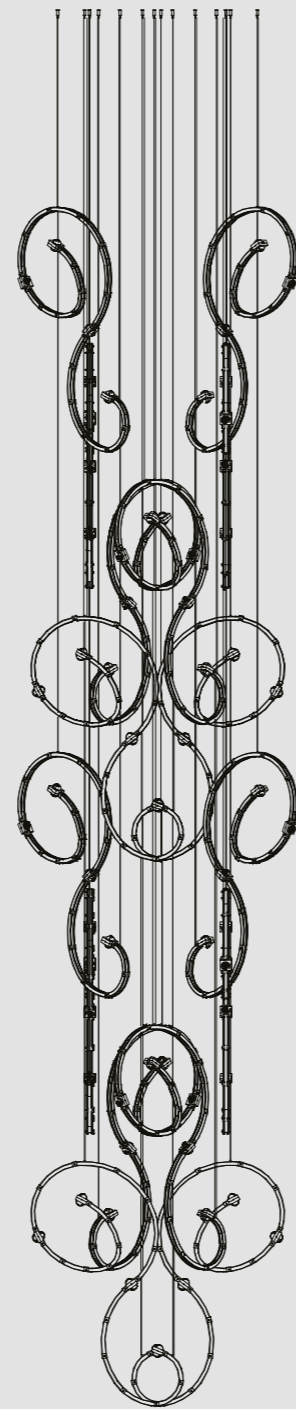


MODULE 1

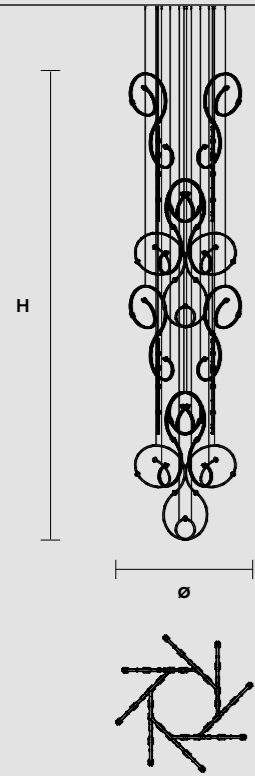
RADIAL / VERTICAL REPETITION



COMPOSITION



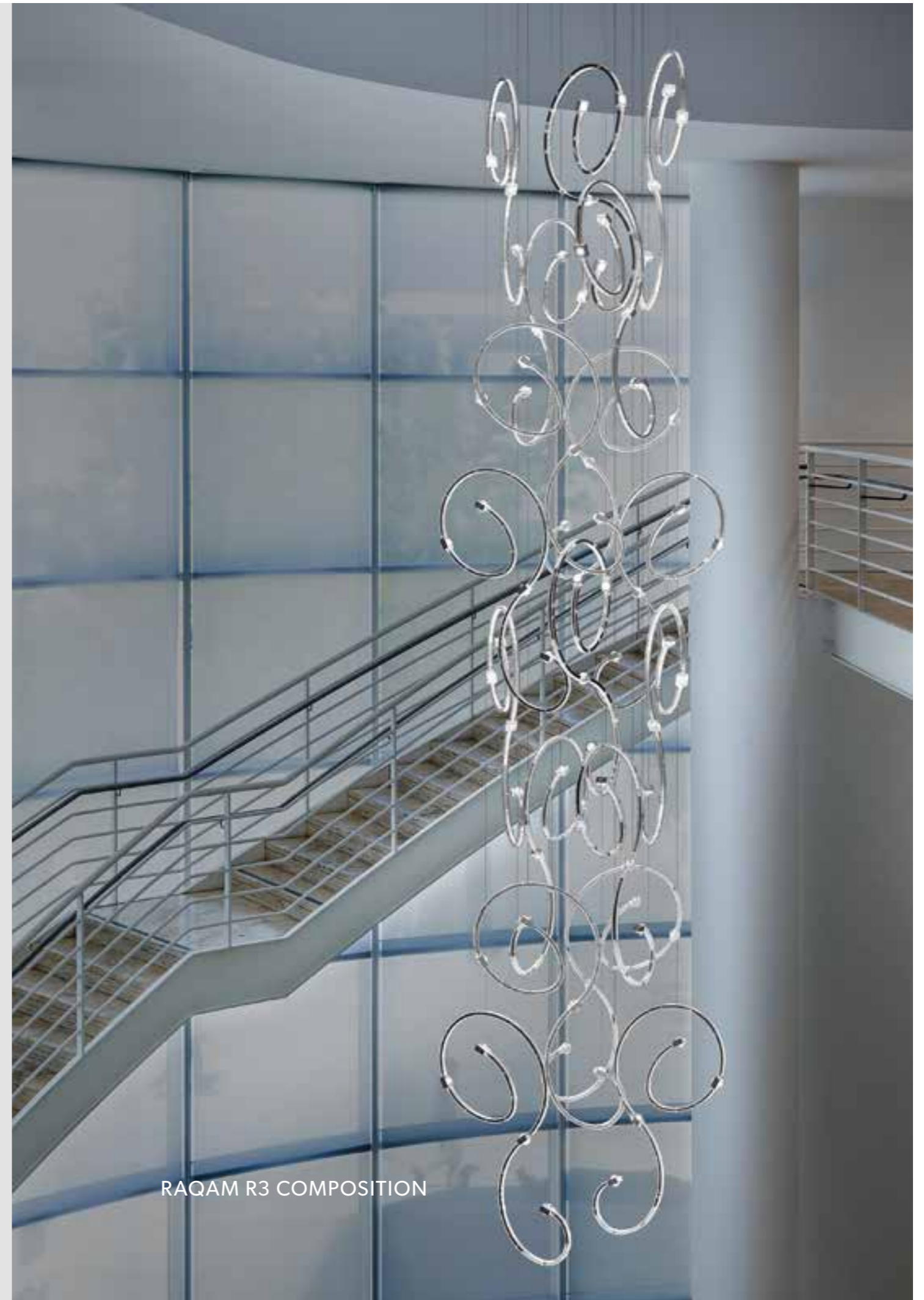
RAQAM R3 COMPOSITION

RAQAM R3 BASIC BATCH A - MODULO 1 X 16

Ø 125 cm / 49.21"
 H 530 cm / 208.66"
 W 52 kg / 114.64 lb

128 LED LIGHTS CRI>80
 3000K - 192 W - 24960 Nominal Lumen
 Dimmable PUSH or DMX on request.

Fixing:
 16 x single steel cables.
 8 x main power supply
 (1 x driver + 1 x control
 board recessed)



RAQAM R3 COMPOSITION

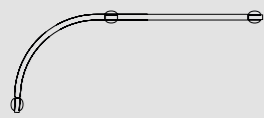
R4 CONCEPT

Vertical/Linear arrangement

MODULES

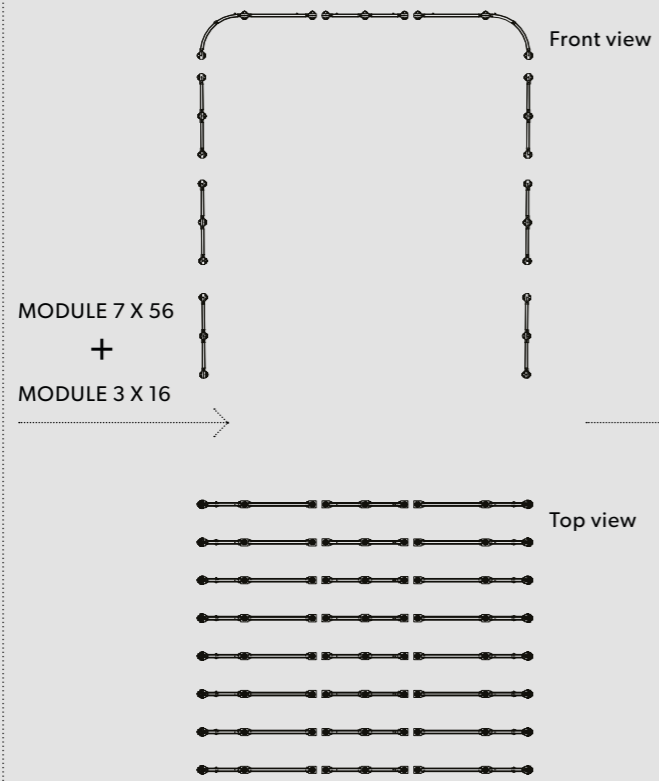


MODULE 7

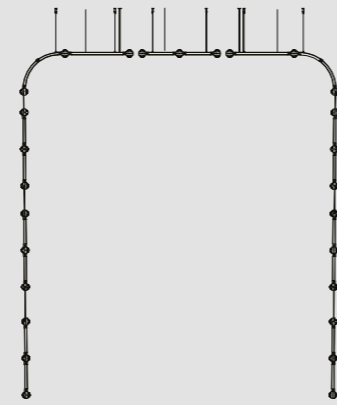


MODULE 3

VERTICAL / LINEAR REPETITION

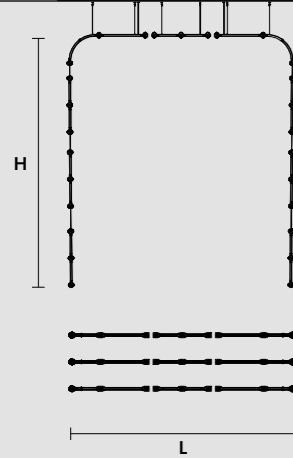


COMPOSITION



RAQAM R4 COMPOSITION

RAQAM R4 BASIC BATCH A – MODULO 3 X 6 + MODULO 7 X 21

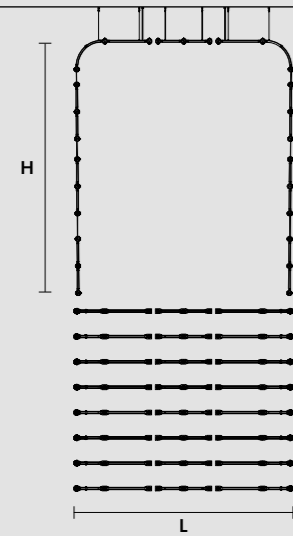


L 227 x 58 cm / 89.37 x 22.83"
 H 250 cm / 98.42"
 W 32 kg / 70.54 lb

162 LED LIGHTS CRI>80
 3000K - 243 W - 31590 Nominal Lumen
 Dimmable PUSH or DMX on request.

Fixing:
 18 x single steel cables.
 15 x main power supply
 (2 x drivers + 2 x control boards recessed)

RAQAM R4 BASIC BATCH B – MODULO 3 X 16 + MODULO 7 X 56



L 227 x 191 cm / 89.37" x 75.19"
 H 250 cm / 98.42"
 W 84 kg / 185.18 lb

432 LED LIGHTS CRI>80
 3000K - 648 W - 84240 Nominal Lumen
 Dimmable PUSH or DMX on request

Fixing:
 48 x single steel cables.
 40 x main power supply
 (5 x drivers + 5 x control boards recessed)



RAQAM R4 COMPOSITION

RAQAM FINISHING

Struttura in metallo ricoperto in vetro. Illuminazione LED.

Metal frame covered with glass: LED lighting system.

Metallstruktur mit transparentem Glas bedeckt. LED Lichtsystem.

Structure métallique recouverte de verre. Éclairage LED.

МЕТАЛЛИЧЕСКИЙ КАРКАС, ПОКРЫТЫЙ СТЕКЛОМ, СВЕТОДИОДНОЕ ОСВЕЩЕНИЕ.

Estructura metálica recubierta de vidrio. Iluminación LED.

这种灯具具有金属跟玻璃放在一起的结构。LED照明。

إطار معدني مُغطى بالزجاج. إضاءة ليد.

Finishings



G04 Chrome Frame
Transparent Glass

G03 Gold Frame
Transparent Glass

G14 Burnished brass
Transparent Glass

CUBO

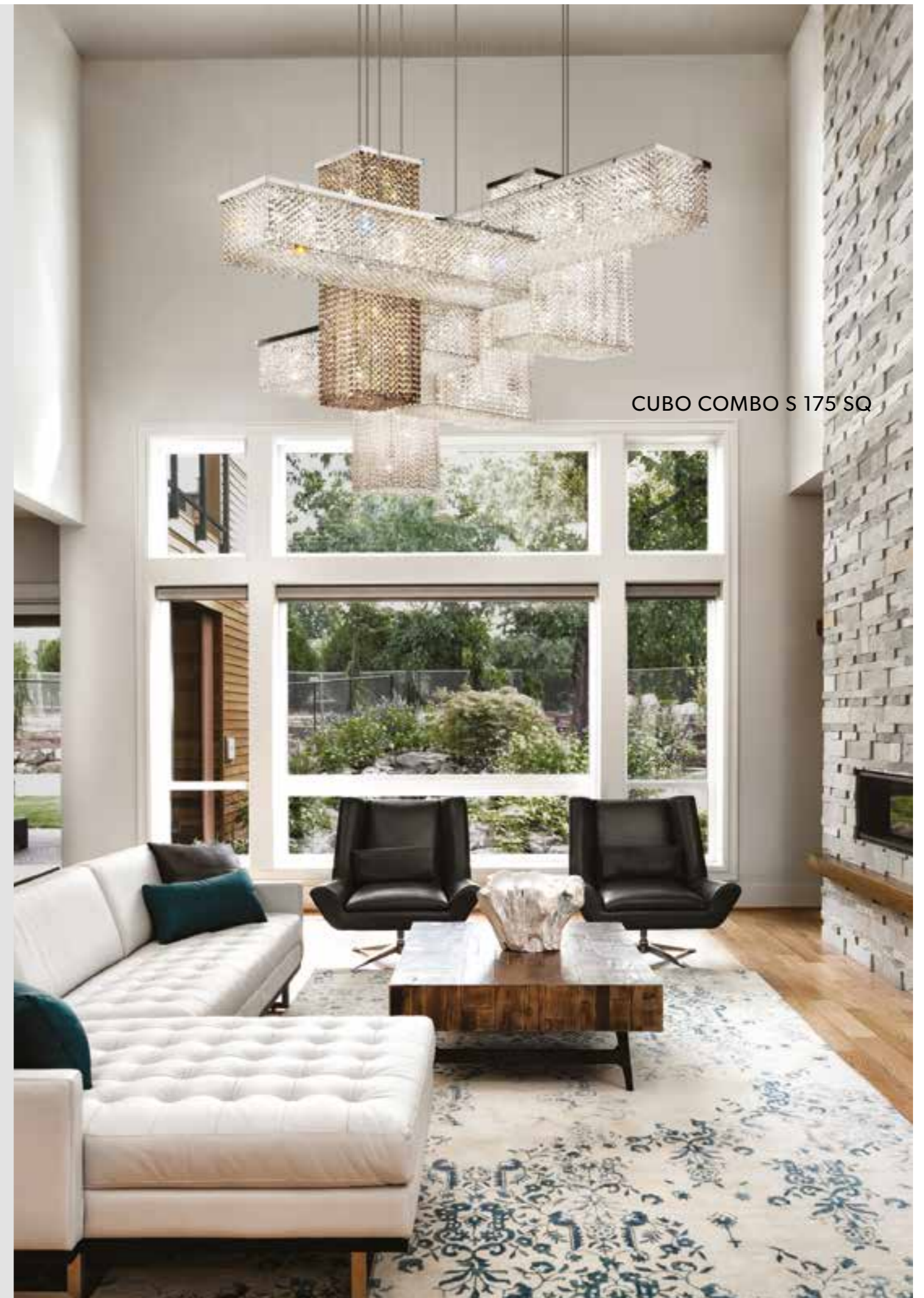
design by Masiero Lab

Cubo è il sistema illuminante a soffitto o sospensione costruito con moduli su base quadrata o rettangolare, dai quali scendono cadute di pendagli.

Dotato di illuminazione tradizionale è adatto a decorare qualsiasi area grazie alla sua modularità.

Cubo is a ceiling or suspension lighting system made up of pendants suspended from modules with a square or rectangular base.

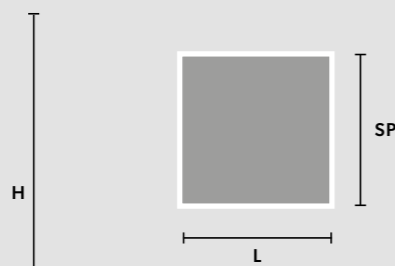
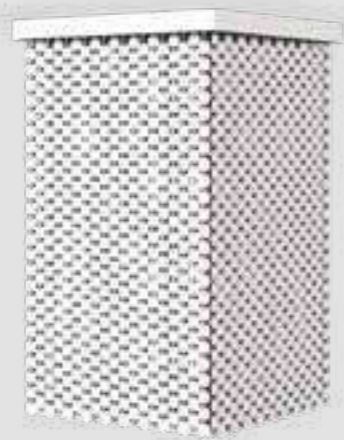
Fitted with traditional lighting, the availability of modules makes it ideal for decorating any space.



CUBO CEILING MODULES

Cubo combo luminaires are created by combining individual modules. Individually electrified square or rectangular modules are available in a range of sizes.

SQUARE MODULES



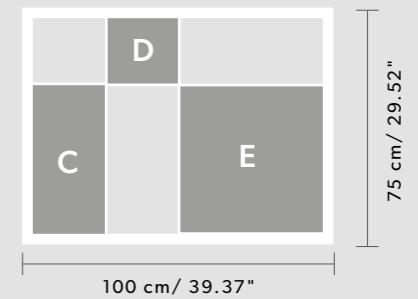
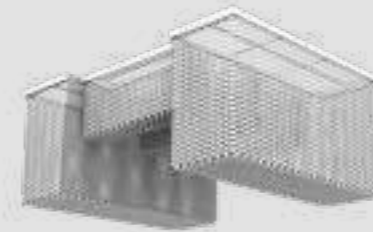
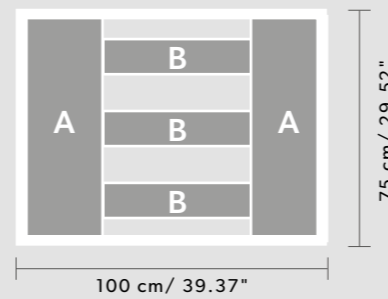
AVAILABLE SIZES

L = SP	Min	12.5 cm / 4.92"
	Max	50 cm / 19.68"
H	Min	20 cm / 7.87"
	Max	80 cm / 31.49"

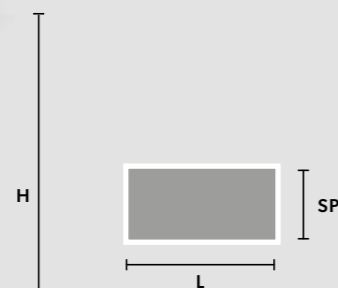
CUBO CEILING COMBO

Any space can be decorated with Cubo modules, creating compositions to suit the setting. Several identical modules, or combinations of different modules, can be used in the same area, or the same mix of modules can be used to decorate different surfaces.

SAME AREA _ DIFFERENT MODULES



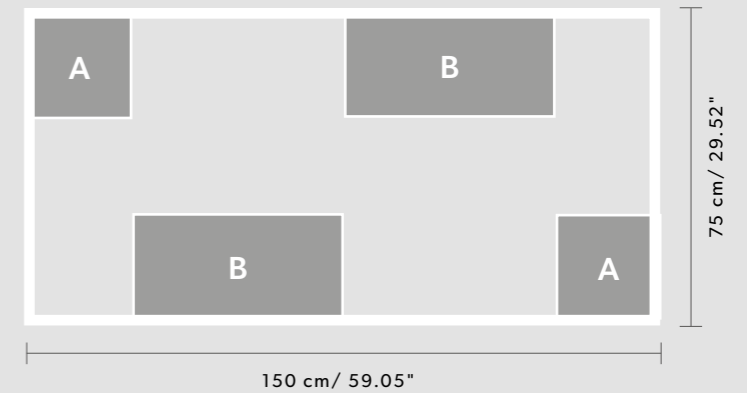
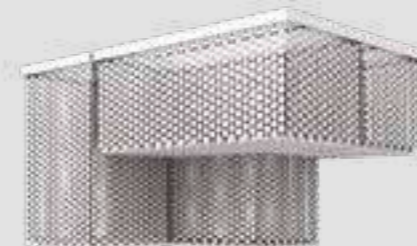
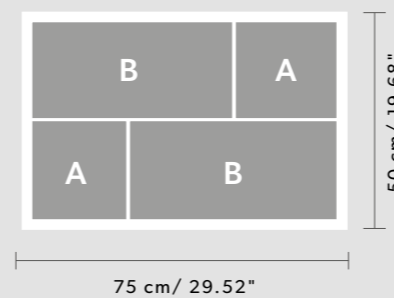
RECTANGULAR MODULES



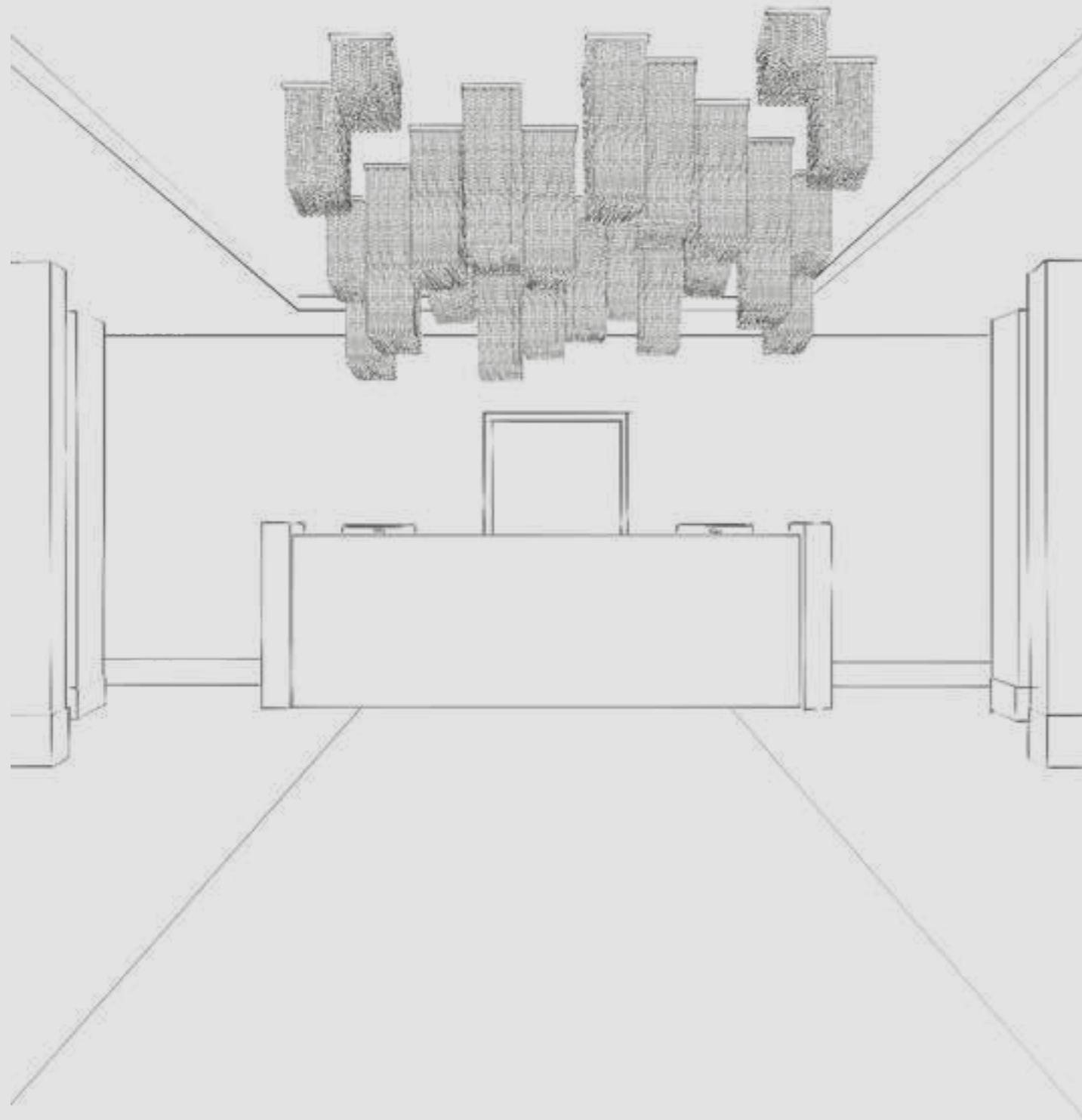
AVAILABLE SIZES

L	Min	25 cm / 9.84"
	Max	100 cm / 39.37"
SP	Min	12.5 cm / 4.92"
	Max	50 cm / 19.68"
H	Min	20 cm / 7.87"
	Max	80 cm / 31.49"

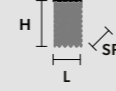
DIFFERENT AREAS _ SAME MODULES



CEILING MODULES



CUBO PL/SQUARE/SMALL/20 CE

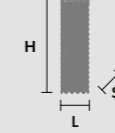


■ SQUARE

L 12.5 cm / 4.92"
SP 12.5 cm / 4.92"
H 20 cm / 7.87"

WW 1×E14×40 W (not included)
USA 1×E12×40 W (not included)

CUBO PL/SQUARE/SMALL/40 CE

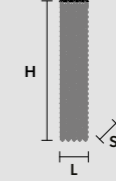


■ SQUARE

L 12.5 cm / 4.92"
SP 12.5 cm / 4.92"
H 40 cm / 15.74"

WW 1×E14×40 W (not included)
USA 1×E12×40 W (not included)

CUBO PL/SQUARE/SMALL/60 CE

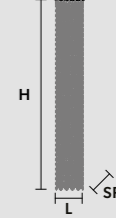


■ SQUARE

L 12.5 cm / 4.92"
SP 12.5 cm / 4.92"
H 60 cm / 23.62"

WW 3×E14×40 W (not included)
USA 3×E12×40 W (not included)

CUBO PL/SQUARE/SMALL/80 CE

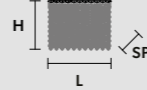


■ SQUARE

L 12.5 cm / 4.92"
SP 12.5 cm / 4.92"
H 80 cm / 31.49"

WW 3×E14×40 W (not included)
USA 3×E12×40 W (not included)

CUBO PL/SQUARE/MEDIUM/20 CE

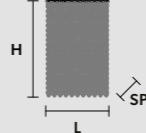


■ SQUARE

L 25 cm / 9.84"
SP 25 cm / 9.84"
H 20 cm / 7.87"

WW 4×E14×40 W (not included)
USA 4×E12×40 W (not included)

CUBO PL/SQUARE/MEDIUM/40 CE

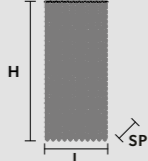


■ SQUARE

L 25 cm / 9.84"
SP 25 cm / 9.84"
H 40 cm / 15.74"

WW 7×E14×40 W (not included)
USA 7×E14×40 W (not included)

CUBO PL/SQUARE/MEDIUM/60 CE

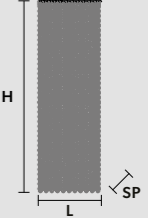


■ SQUARE

L 25 cm / 9.84"
SP 25 cm / 9.84"
H 60 cm / 23.62"

WW 8×E14×40 W (not included)
USA 8×E12×40 W (not included)

CUBO PL/SQUARE/MEDIUM/80 CE

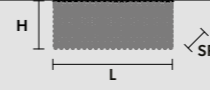


■ SQUARE

L 25 cm / 9.84"
SP 25 cm / 9.84"
H 80 cm / 31.49"

WW 10×E14×40 W (not included)
USA 10×E12×40 W (not included)

CUBO PL/SQUARE/LARGE/20 CE

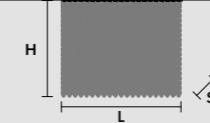


■ SQUARE

L 50 cm / 19.68"
SP 50 cm / 19.68"
H 20 cm / 7.87"

WW 12×E14×40 W (not included)
USA 12×E12×40 W (not included)

CUBO PL/SQUARE/LARGE/40 CE

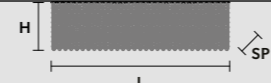
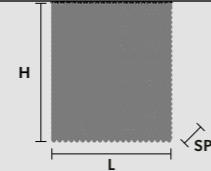
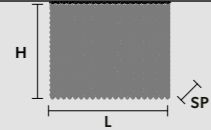
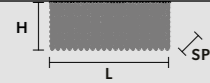


■ SQUARE

L 50 cm / 19.68"
SP 50 cm / 19.68"
H 40 cm / 15.74"

WW 12×E14×40 W (not included)
USA 12×E12×40 W (not included)

CUBO PL/LONG/A **CUBO PL/LONG/B** **CUBO PL/LONG/C** **CUBO PL/LONG/D**



RECTANGULAR

L 50 cm / 19.68"
SP 12.5 cm / 4.92"
H 20 cm / 7.87"

WW 4×E14×40 W (not included)
USA 4×E12×40 W (not included)

RECTANGULAR

L 50 cm / 19.68"
SP 12.5 cm / 4.92"
H 40 cm / 15.74"

WW 7×E14×40 W (not included)
USA 7×E12×40 W (not included)

RECTANGULAR

L 50 cm / 19.68"
SP 12.5 cm / 4.92"
H 60 cm / 23.62"

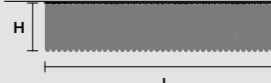
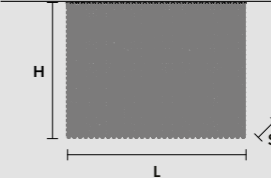
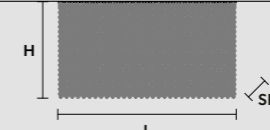
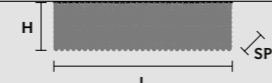
WW 7×E14×40 W (not included)
USA 7×E12×40 W (not included)

RECTANGULAR

L 75 cm / 29.52"
SP 12.5 cm / 4.92"
H 20 cm / 7.87"

WW 5×E14×40 W (not included)
USA 5×E12×40 W (not included)

CUBO PL/LONG/M **CUBO PL/LONG/N** **CUBO PL/LONG/O** **CUBO PL/LONG/P**



RECTANGULAR

L 75 cm / 29.52"
SP 25 cm / 9.84"
H 20 cm / 7.87"

WW 9×E14×40 W (not included)
USA 9×E12×40 W (not included)

RECTANGULAR

L 75 cm / 29.52"
SP 25 cm / 9.84"
H 40 cm / 15.74"

WW 17×E14×40 W (not included)
USA 17×E12×40 W (not included)

RECTANGULAR

L 75 cm / 29.52"
SP 25 cm / 9.84"
H 60 cm / 23.62"

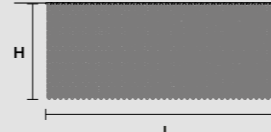
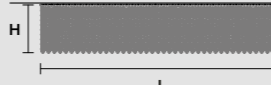
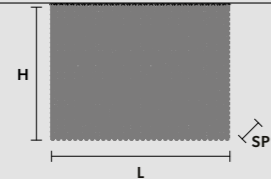
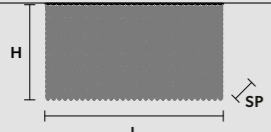
WW 17×E14×40 W (not included)
USA 17×E12×40 W (not included)

RECTANGULAR

L 100 cm / 39.37"
SP 25 cm / 9.84"
H 20 cm / 7.87"

WW 12×E14×40 W (not included)
USA 12×E12×40 W (not included)

CUBO PL/LONG/E **CUBO PL/LONG/F** **CUBO PL/LONG/G** **CUBO PL/LONG/H**



RECTANGULAR

L 75 cm / 29.52"
SP 12.5 cm / 4.92"
H 40 cm / 15.74"

WW 9×E14×40 W (not included)
USA 9×E12×40 W (not included)

RECTANGULAR

L 75 cm / 29.52"
SP 12.5 cm / 4.92"
H 60 cm / 23.62"

WW 9×E14×40 W (not included)
USA 9×E12×40 W (not included)

RECTANGULAR

L 100 cm / 39.37"
SP 12.5 cm / 4.92"
H 20 cm / 7.87"

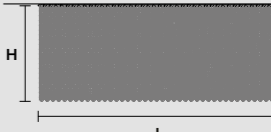
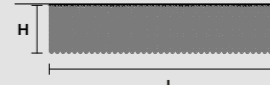
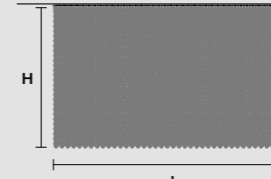
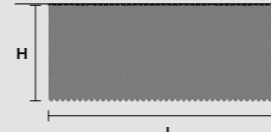
WW 6×E14×40 W (not included)
USA 6×E12×40 W (not included)

RECTANGULAR

L 100 cm / 39.37"
SP 12.5 cm / 4.92"
H 40 cm / 15.74"

WW 11×E14×40 W (not included)
USA 11×E12×40 W (not included)

CUBO PL/LONG/Q **CUBO PL/LONG/R** **CUBO PL/LONG/S** **CUBO PL/LONG/T**



RECTANGULAR

L 100 cm / 39.37"
SP 25 cm / 9.84"
H 40 cm / 15.74"

WW 18×E14×40 W (not included)
USA 18×E12×40 W (not included)

RECTANGULAR

L 100 cm / 39.37"
SP 25 cm / 9.84"
H 60 cm / 23.62"

WW 18×E14×40 W (not included)
USA 18×E12×40 W (not included)

RECTANGULAR

L 100 cm / 39.37"
SP 50 cm / 19.68"
H 20 cm / 7.87"

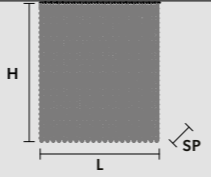
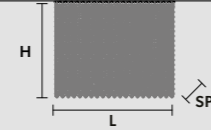
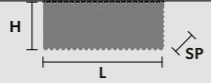
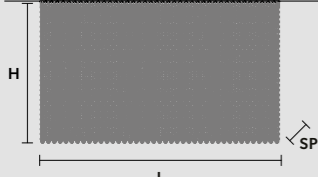
WW 12×E14×40 W (not included)
USA 12×E12×40 W (not included)

RECTANGULAR

L 100 cm / 39.37"
SP 50 cm / 19.68"
H 40 cm / 15.74"

WW 18×E14×40 W (not included)
USA 18×E12×40 W (not included)

CUBO PL/LONG/I **CUBO PL/LONG/J** **CUBO PL/LONG/K** **CUBO PL/LONG/L**



RECTANGULAR

L 100 cm / 39.37"
SP 12.5 cm / 4.92"
H 60 cm / 23.62"

WW 11×E14×40 W (not included)
USA 11×E12×40 W (not included)

RECTANGULAR

L 50 cm / 19.68"
SP 25 cm / 9.84"
H 20 cm / 7.87"

WW 8×E14×40 W (not included)
USA 8×E12×40 W (not included)

RECTANGULAR

L 50 cm / 19.68"
SP 25 cm / 9.84"
H 40 cm / 15.74"

WW 12×E14×40 W (not included)
USA 12×E12×40 W (not included)

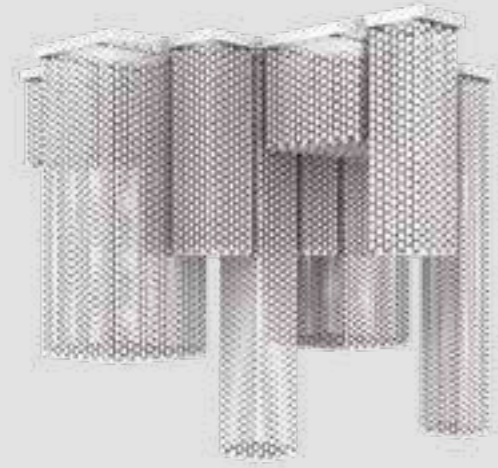
RECTANGULAR

L 50 cm / 19.68"
SP 25 cm / 9.84"
H 60 cm / 23.62"

WW 12×E14×40 W (not included)
USA 12×E12×40 W (not included)

CUBO COMBO PL 100 SQ

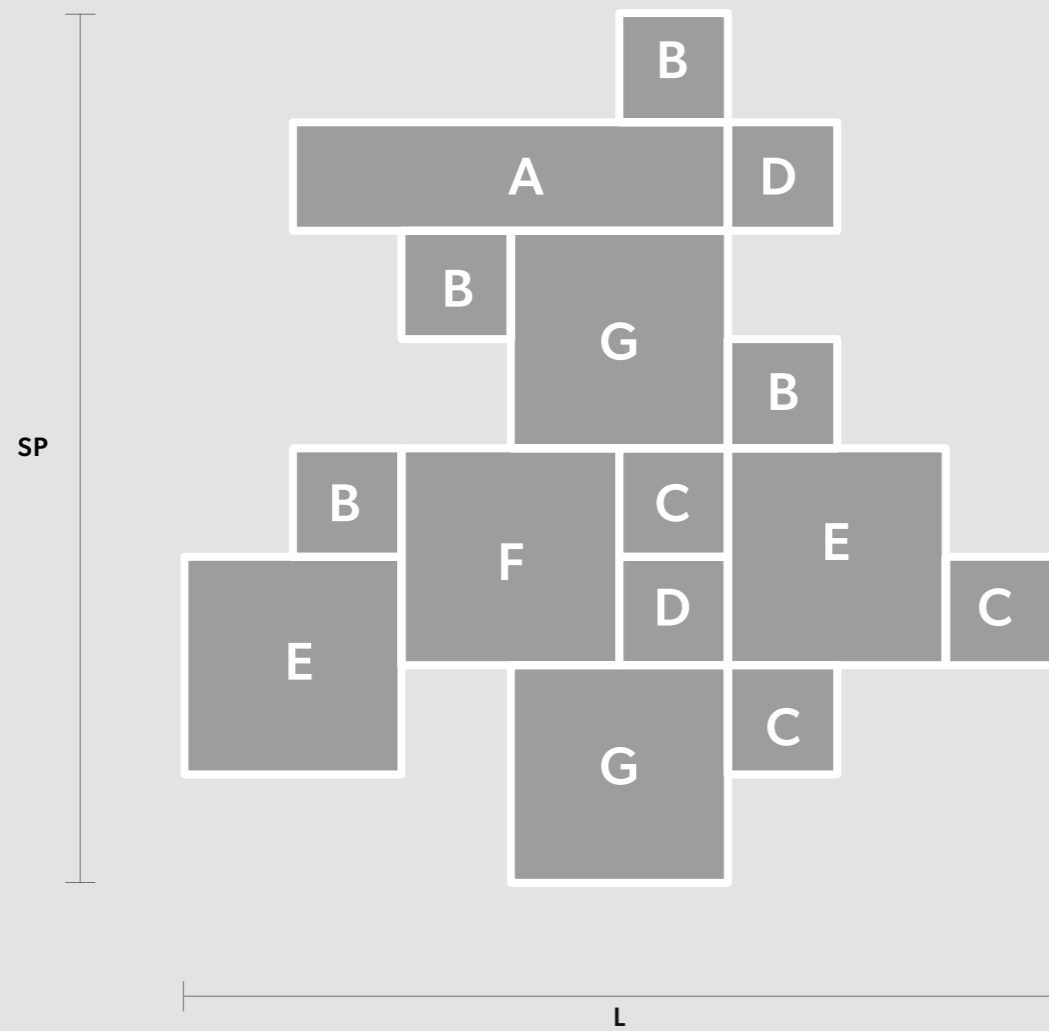
CE



L 100 cm / 39.37" **WW** 43×E14×40 W (not included)
SP 100 cm / 39.37" **USA** 43×E12×40 W (not included)
H 80 cm / 31.49"

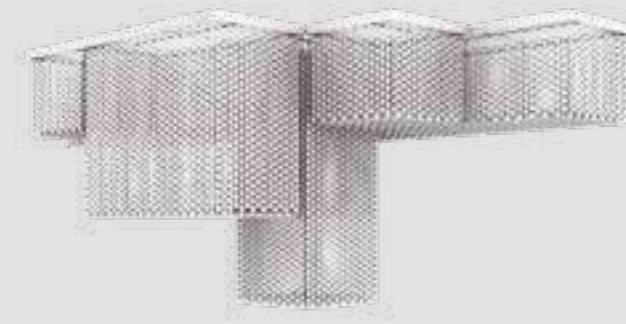
Composition

- A** 1 x Cubo/PL/Long/B
- B** 4 x Cubo/PL/Square/Small/20
- C** 3 x Cubo/PL/Square/Small/40
- D** 2 x Cubo/PL/Square/Small/80
- E** 2 x Cubo/PL/Square/Medium/20
- F** 1 x Cubo/PL/Square/Medium/40
- G** 2 x Cubo/PL/Square/Medium/60



CUBO COMBO PL 150 RC

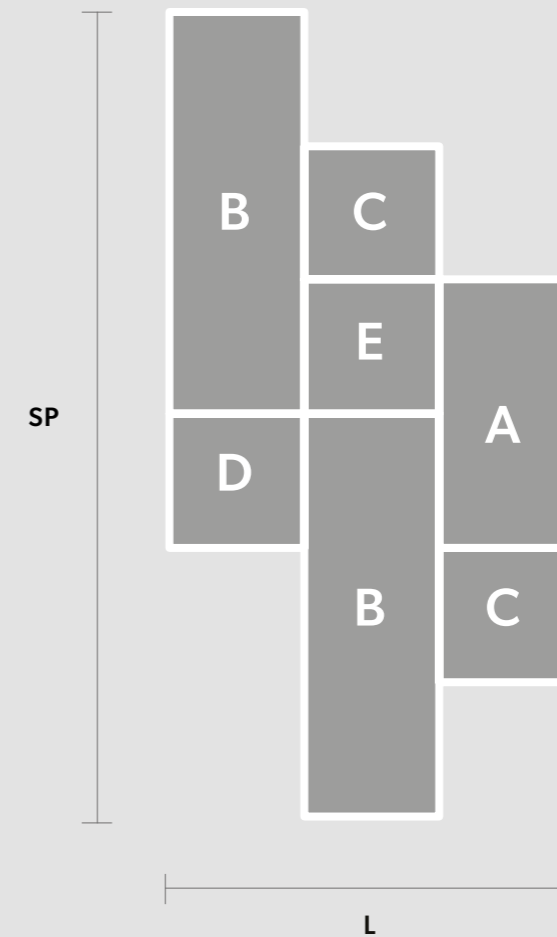
CE



L 75 cm / 29.52" **WW** 53×E14×40 W (not included)
SP 150 cm / 59.05" **USA** 53×E12×40 W (not included)
H 60 cm / 23.62"

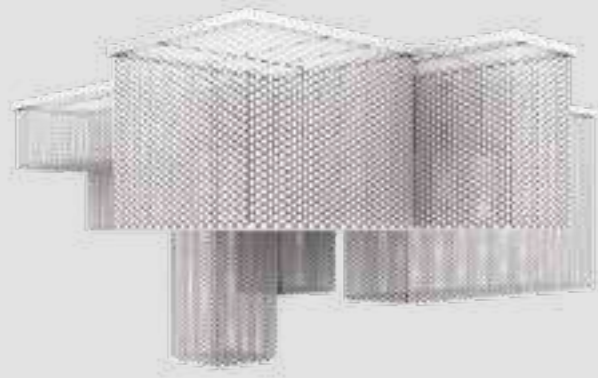
Composition

- A** 1 x Cubo/PL/Long/K
- B** 2 x Cubo/PL/Long/M
- C** 2 x Cubo/PL/Square/Medium/20
- D** 1 x Cubo/PL/Square/Medium/40
- E** 1 x Cubo/PL/Square/Medium/60



CUBO COMBO PL 175 SQ

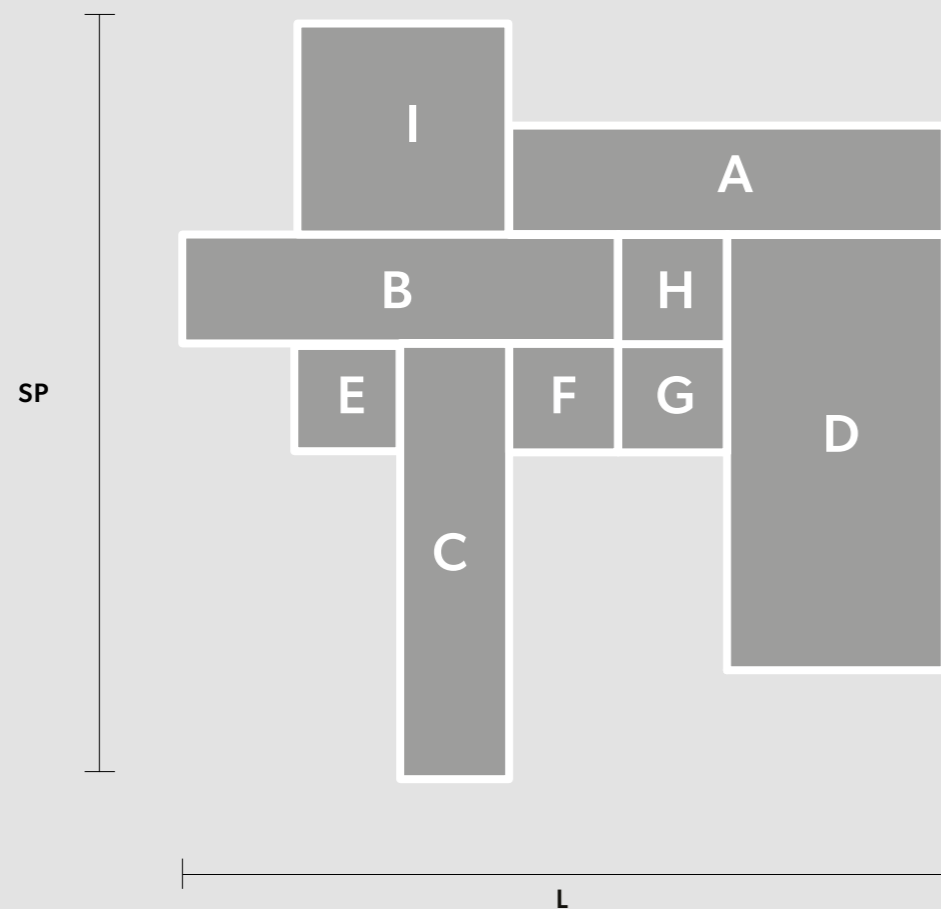
CE



L 175 cm / 68.89" **WW** 107×E14×40 W (not included)
SP 175 cm / 68.89" **USA** 107×E12×40 W (not included)
H 80 cm / 31.49"

Composition

- A** 1 x Cubo PL/Long/P
- B** 1 x Cubo PL/Long/Q
- C** 1 x Cubo PL/Long/R
- D** 1 x Cubo PL/Long/T
- E** 1 x Cubo PL/Square/Medium/20
- F** 1 x Cubo PL/Square/Medium/40
- G** 1 x Cubo PL/Square/Medium/60
- H** 1 x Cubo PL/Square/Medium/80
- I** 1 x Cubo PL/Square/Large 40



CUBO COMBO PL 175 SQ

CUBO COMBO PL 21 200 SQ

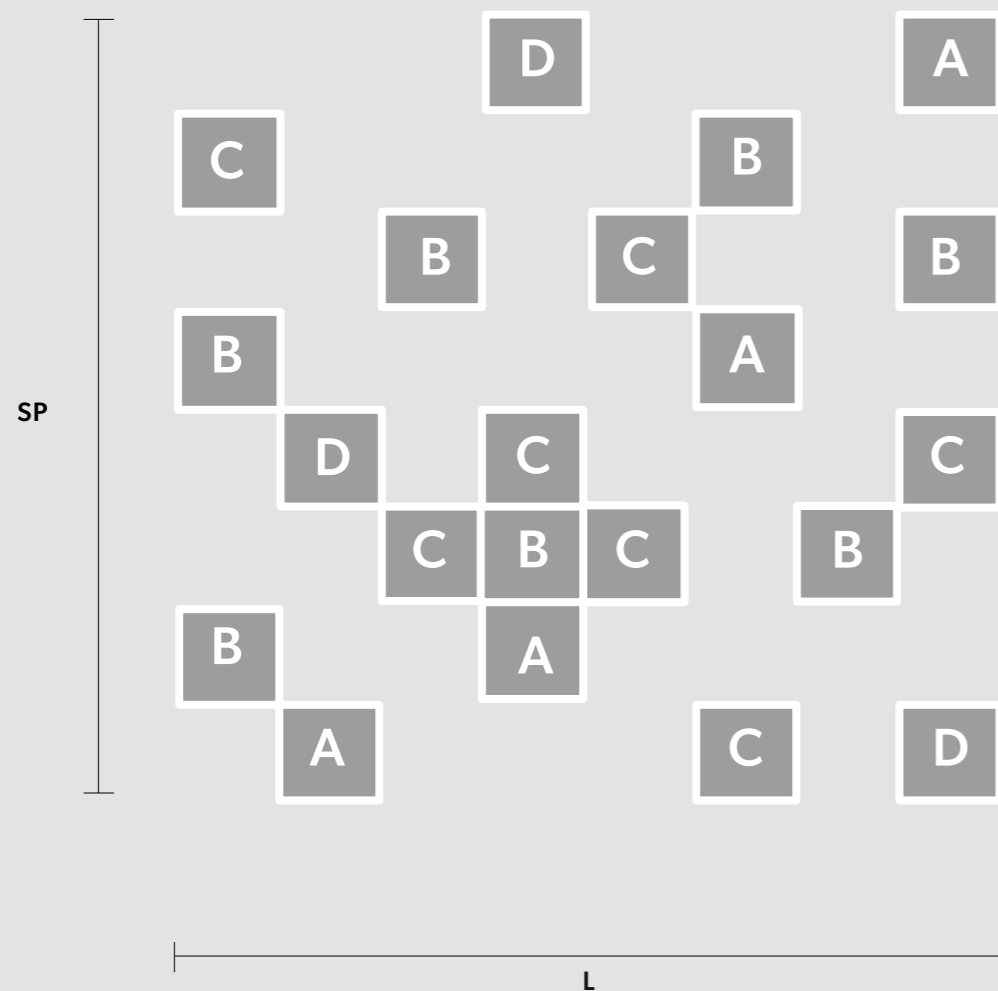
CE



L 200 cm / 78.74" WW 151×E14×40 W (not included)
 SP 200 cm / 78.74" USA 151×E12×40 W (not included)
 H 80 cm / 31.49"

Composition

- A 4 X Cubo PL/Square/Medium/20
- B 7 X Cubo PL/Square/Medium/40
- C 7 X Cubo PL/Square/Medium/60
- D 3 X Cubo PL/Square/Medium/80



CUBO COMBO PL 21 200 SQ

CUBO COMBO PL 8 200 SQ

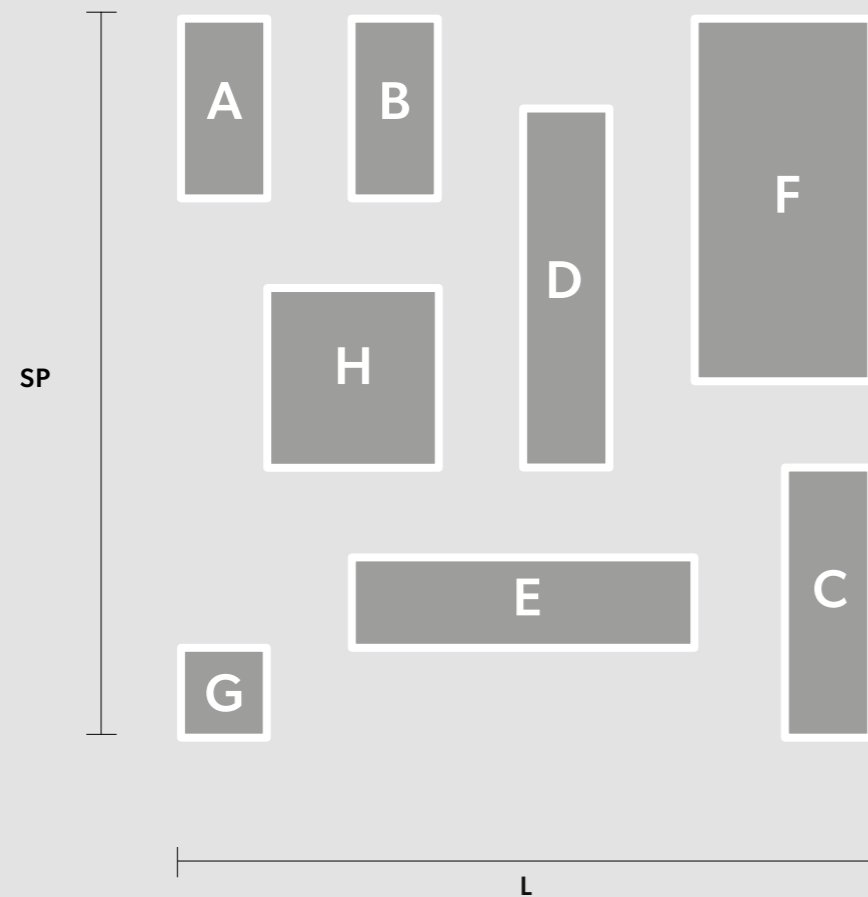
CE



L 200 cm / 78.74" **WW** 95×E14×40 W (not included)
SP 200 cm / 78.74" **USA** 95×E12×40 W (not included)
H 60 cm / 23.62"

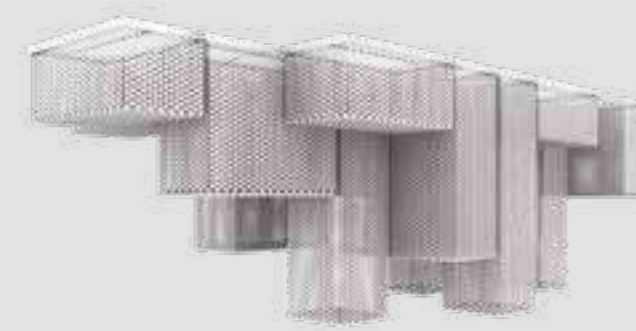
Composition

- A** 1 x Cubo PL/Long/J
- B** 1 x Cubo PL/Long/L
- C** 1 x Cubo PL/Long/N
- D** 1 x Cubo PL/Long/P
- E** 1 x Cubo PL/Long/Q
- F** 1 x Cubo PL/Long/S
- G** 1 x Cubo PL/Square/Medium/20
- H** 1 x Cubo PL/Square/Large 40



CUBO COMBO PL 300 RC

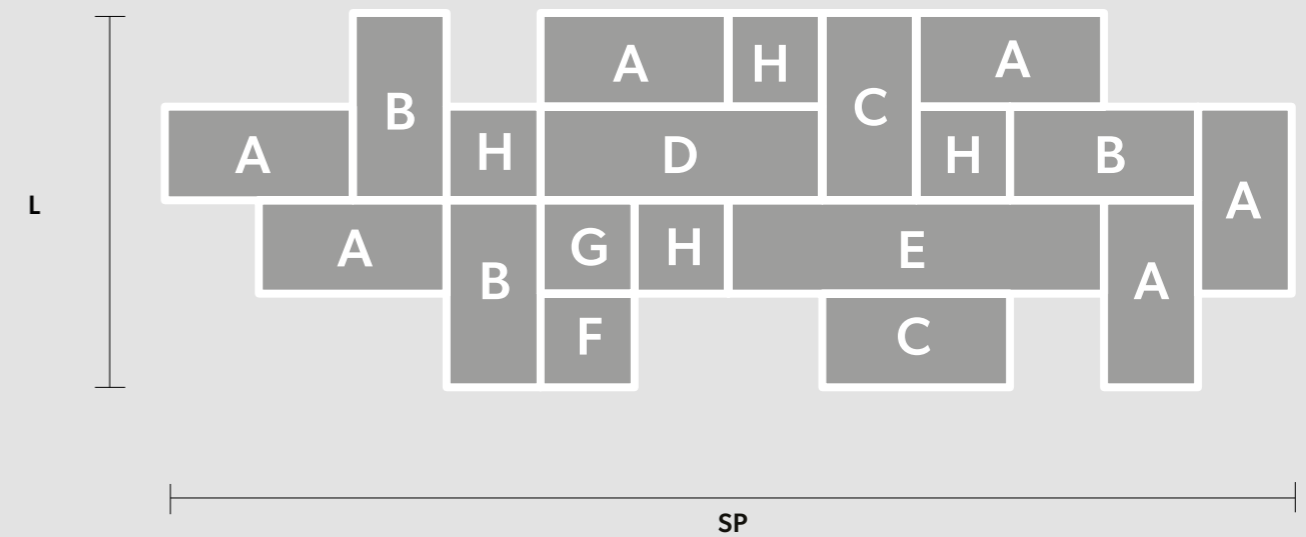
CE



L 100 cm / 39.37" **WW** 195×E14×40 W (not included)
SP 300 cm / 118.11" **USA** 195×E12×40 W (not included)
H 80 cm / 31.49"

Composition

- A** 6 x Cubo/PL/Long/J
- B** 3 x Cubo/PL/Long/K
- C** 2 x Cubo/PL/Long/L
- D** 1 x Cubo/PL/Long/O
- E** 1 x Cubo/PL/Long/Q
- F** 1 x Cubo/PL/Square/Medium/20
- G** 1 x Cubo/PL/Square/Medium/60
- H** 4 x Cubo/PL/Square/Medium/80



CUBO COMBO PL 16 200 RC

CE

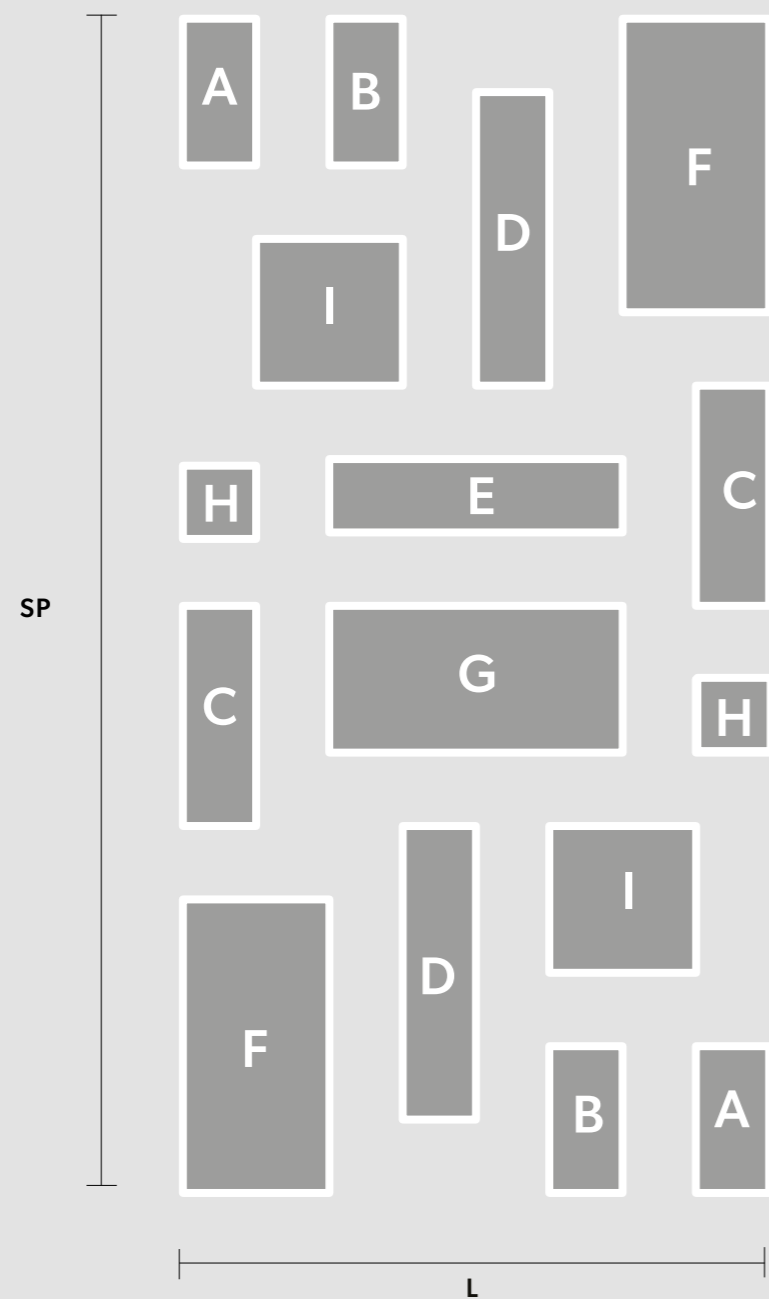


L 200 cm / 78.74"
SP 400 cm / 157.48"
H 60 cm / 23.62"

WW 190×E14×40 W (not included)
USA 190×E12×40 W (not included)

Composition

- A** 2 x Cubo PL/Long/J
- B** 2 x Cubo PL/Long/L
- C** 2 x Cubo PL/Long/N
- D** 2 x Cubo PL/Long/P
- E** 1 x Cubo PL/Long/Q
- F** 2 x Cubo PL/Long/S
- G** 1 x Cubo PL/Long/T
- H** 2 x Cubo PL/Square/Medium/20
- I** 2 x Cubo PL/Square/Large/40



CUBO COMBO PL 16 200 RC
COMPOSITION

CUBO SUSPENSION MODULES

The Cubo combo suspensions are created by using combinations of individual modules. Individually electrified square or rectangular modules are available in a range of sizes.

SQUARE MODULES



STANDARD CABLE 150 cm / 59.05"

H



SP

AVAILABLE SIZES

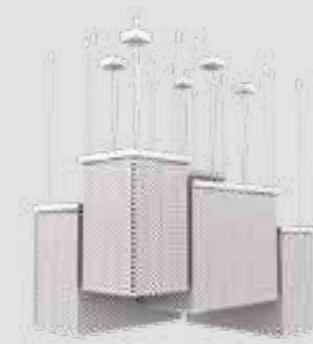
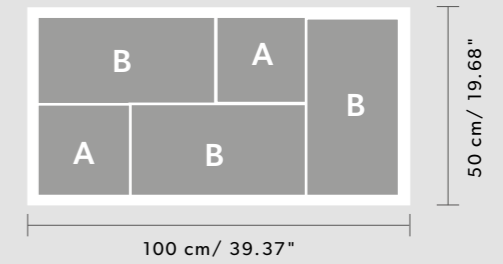
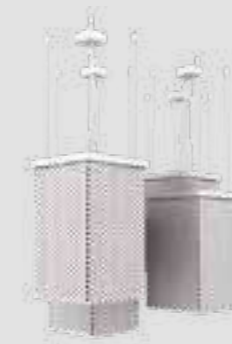
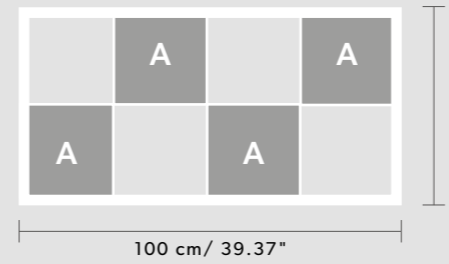
L = SP Min 12.5 cm / 4.92"
Max 50 cm / 19.68"

H Min 20 cm / 7.87"
Max 80 cm / 31.49"

CUBO SUSPENSION COMBO

Any space can be decorated with Cubo modules, creating compositions to suit the setting. Several identical modules, or combinations of different modules, can be used in the same area, or the same mix of modules can be used to decorate different surfaces.

SAME AREA _DIFFERENT MODULES



RECTANGULAR MODULES



STANDARD CABLE 150 cm / 59.05"

H



SP

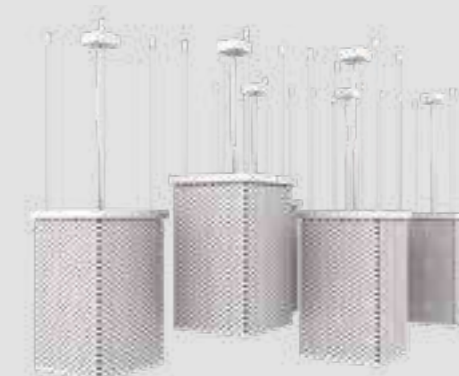
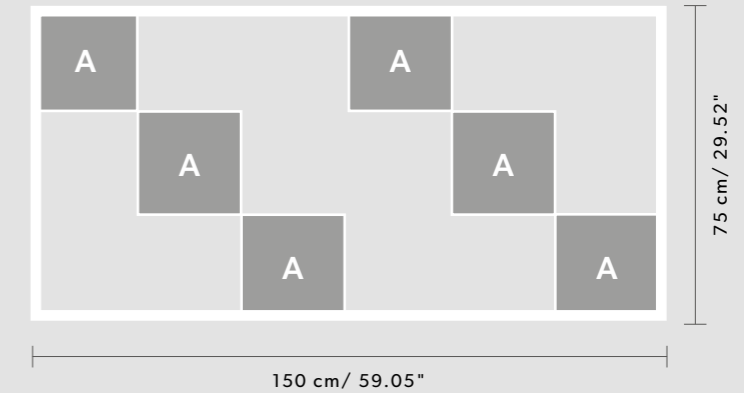
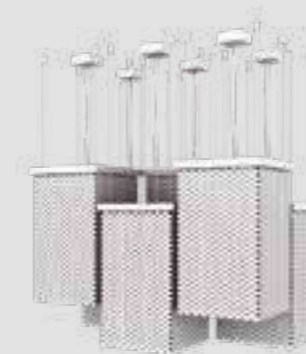
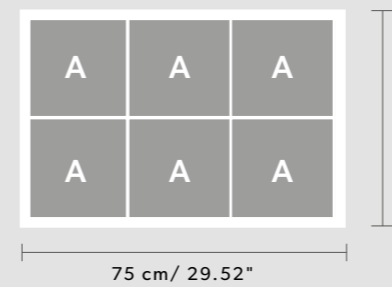
AVAILABLE SIZES

L Min 25 cm / 9.84"
Max 100 cm / 39.37"

SP Min 12.5 cm / 4.92"
Max 50 cm / 19.68"

H Min 20 cm / 7.87"
Max 80 cm / 31.49"

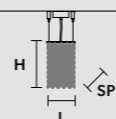
DIFFERENT AREAS _ SAME MODULES



MODULES SUSPENSION



CUBO S/SQUARE/SMALL/20 CE

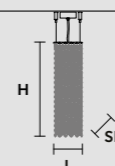


SQUARE

L 12.5 cm / 4.92"
SP 12.5 cm / 4.92"
H 20 cm / 7.87"

WW 1×E14×40 W (not included)
USA 1×E12×40 W (not included)

CUBO S/SQUARE/SMALL/40 CE

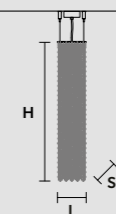


SQUARE

L 12.5 cm / 4.92"
SP 12.5 cm / 4.92"
H 40 cm / 15.74"

WW 1×E14×40 W (not included)
USA 1×E12×40 W (not included)

CUBO S/SQUARE/SMALL/60 CE

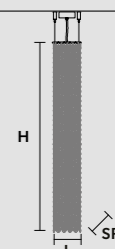


SQUARE

L 12.5 cm / 4.92"
SP 12.5 cm / 4.92"
H 60 cm / 23.62"

WW 3×E14×40 W (not included)
USA 3×E12×40 W (not included)

CUBO S/SQUARE/SMALL/80 CE

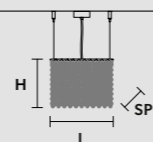


SQUARE

L 12.5 cm / 4.92"
SP 12.5 cm / 4.92"
H 80 cm / 31.49"

WW 3×E14×40 W (not included)
USA 3×E12×40 W (not included)

CUBO S/SQUARE/MEDIUM/20 CE

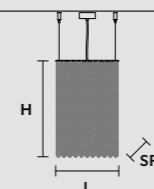


SQUARE

L 25 cm / 9.84"
SP 25 cm / 9.84"
H 20 cm / 7.87"

WW 4×E14×40 W (not included)
USA 4×E12×40 W (not included)

CUBO S/SQUARE/MEDIUM/40 CE

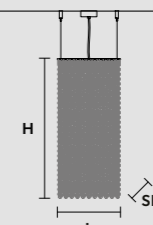


SQUARE

L 25 cm / 9.84"
SP 25 cm / 9.84"
H 40 cm / 15.74"

WW 7×E14×40 W (not included)
USA 7×E12×40 W (not included)

CUBO S/SQUARE/MEDIUM/60 CE

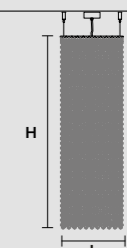


SQUARE

L 25 cm / 9.84"
SP 25 cm / 9.84"
H 60 cm / 23.62"

WW 8×E14×40 W (not included)
USA 8×E12×40 W (not included)

CUBO S/SQUARE/MEDIUM/80 CE

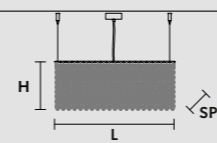


SQUARE

L 25 cm / 9.84"
SP 25 cm / 9.84"
H 80 cm / 31.49"

WW 10×E14×40 W (not included)
USA 10×E12×40 W (not included)

CUBO S/SQUARE/LARGE/20 CE

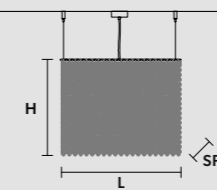


SQUARE

L 50 cm / 19.68"
SP 50 cm / 19.68"
H 20 cm / 7.87"

WW 12×E14×40 W (not included)
USA 12×E12×40 W (not included)

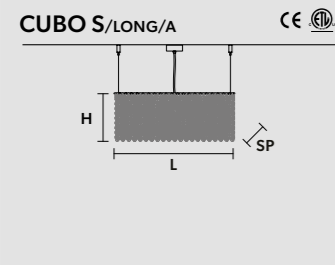
CUBO S/SQUARE/LARGE/40 CE



SQUARE

L 50 cm / 19.68"
SP 50 cm / 19.68"
H 40 cm / 15.74"

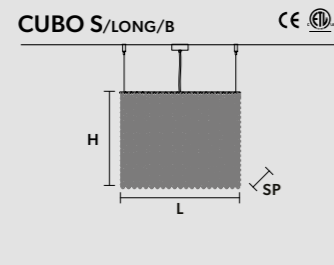
WW 12×E14×40 W (not included)
USA 12×E12×40 W (not included)



RECTANGULAR

L 50 cm / 19.68"
 SP 12.5 cm / 4.92"
 H 20 cm / 7.87"

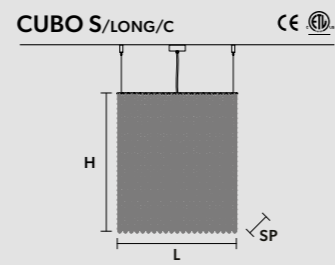
WW 4×E14×40 W (not included)
 USA 4×E12×40 W (not included)



RECTANGULAR

L 50 cm / 19.68"
 SP 12.5 cm / 4.92"
 H 40 cm / 15.74"

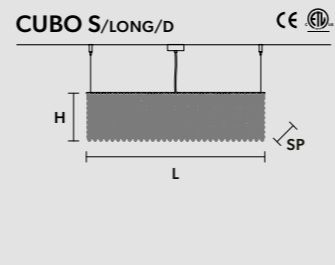
WW 7×E14×40 W (not included)
 USA 7×E12×40 W (not included)



RECTANGULAR

L 50 cm / 19.68"
 SP 12.5 cm / 4.92"
 H 60 cm / 23.62"

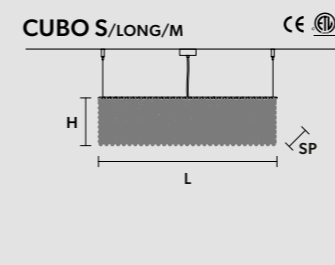
WW 7×E14×40 W (not included)
 USA 7×E12×40 W (not included)



RECTANGULAR

L 75 cm / 29.52"
 SP 12.5 cm / 4.92"
 H 20 cm / 7.87"

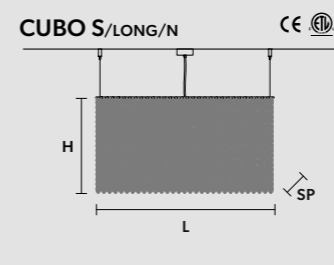
WW 5×E14×40 W (not included)
 USA 5×E12×40 W (not included)



RECTANGULAR

L 75 cm / 29.52"
 SP 25 cm / 9.84"
 H 20 cm / 7.87"

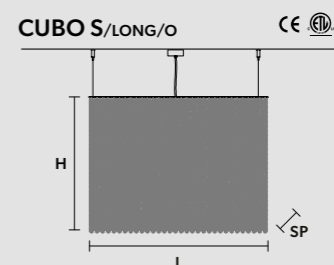
WW 9×E14×40 W (not included)
 USA 9×E12×40 W (not included)



RECTANGULAR

L 75 cm / 29.52"
 SP 25 cm / 9.84"
 H 40 cm / 15.74"

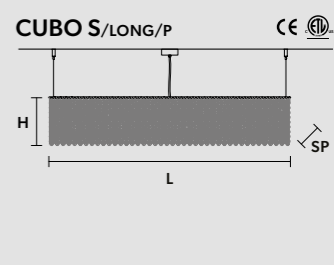
WW 17×E14×40 W (not included)
 USA 17×E12×40 W (not included)



RECTANGULAR

L 75 cm / 29.52"
 SP 25 cm / 9.84"
 H 60 cm / 23.62"

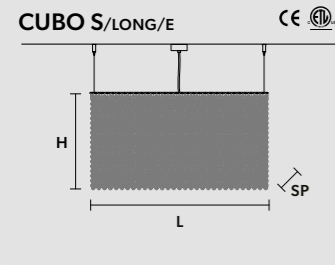
WW 17×E14×40 W (not included)
 USA 17×E12×40 W (not included)



RECTANGULAR

L 100 cm / 39.37"
 SP 25 cm / 9.84"
 H 20 cm / 7.87"

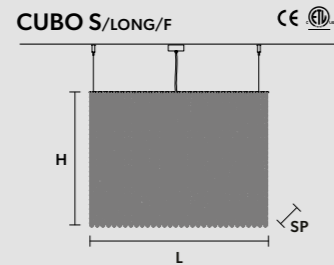
WW 12×E14×40 W (not included)
 USA 12×E12×40 W (not included)



RECTANGULAR

L 75 cm / 29.52"
 SP 12.5 cm / 4.92"
 H 40 cm / 15.74"

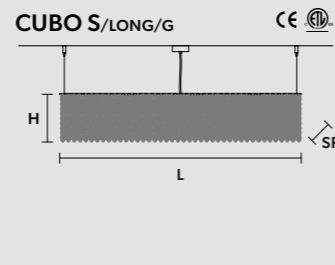
WW 9×E14×40 W (not included)
 USA 9×E12×40 W (not included)



RECTANGULAR

L 75 cm / 29.52"
 SP 12.5 cm / 4.92"
 H 60 cm / 23.62"

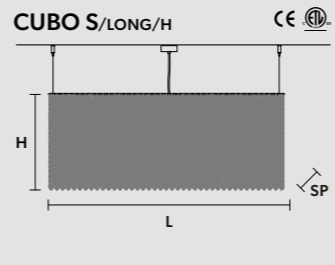
WW 9×E14×40 W (not included)
 USA 9×E12×40 W (not included)



RECTANGULAR

L 100 cm / 39.37"
 SP 12.5 cm / 4.92"
 H 20 cm / 7.87"

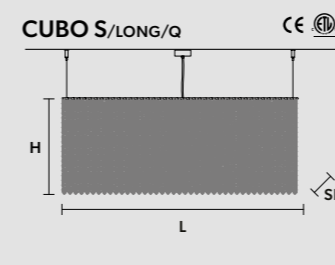
WW 6×E14×40 W (not included)
 USA 6×E12×40 W (not included)



RECTANGULAR

L 100 cm / 39.37"
 SP 12.5 cm / 4.92"
 H 40 cm / 15.74"

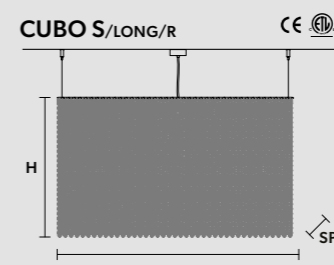
WW 11×E14×40 W (not included)
 USA 11×E12×40 W (not included)



RECTANGULAR

L 100 cm / 39.37"
 SP 25 cm / 9.84"
 H 40 cm / 15.74"

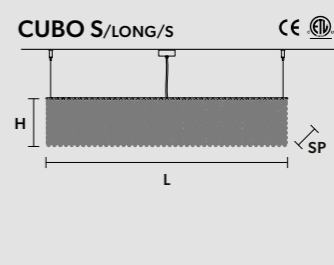
WW 18×E14×40 W (not included)
 USA 18×E12×40 W (not included)



RECTANGULAR

L 100 cm / 39.37"
 SP 25 cm / 9.84"
 H 60 cm / 23.62"

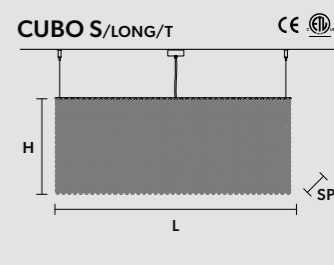
WW 18×E14×40 W (not included)
 USA 18×E12×40 W (not included)



RECTANGULAR

L 100 cm / 39.37"
 SP 50 cm / 19.68"
 H 20 cm / 7.87"

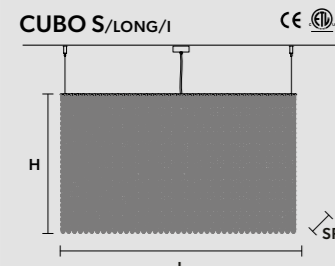
WW 12×E14×40 W (not included)
 USA 12×E12×40 W (not included)



RECTANGULAR

L 100 cm / 39.37"
 SP 50 cm / 19.68"
 H 40 cm / 15.74"

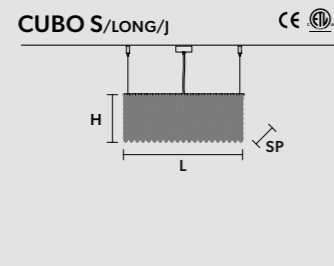
WW 18×E14×40 W (not included)
 USA 18×E12×40 W (not included)



RECTANGULAR

L 100 cm / 39.37"
 SP 12.5 cm / 4.92"
 H 60 cm / 23.62"

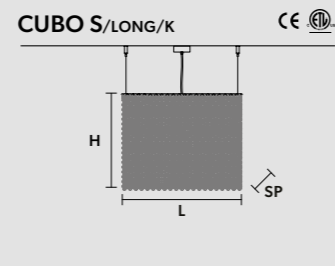
WW 11×E14×40 W (not included)
 USA 11×E12×40 W (not included)



RECTANGULAR

L 50 cm / 19.68"
 SP 25 cm / 9.84"
 H 20 cm / 7.87"

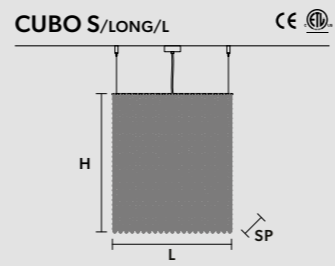
WW 8×E14×40 W (not included)
 USA 8×E12×40 W (not included)



RECTANGULAR

L 50 cm / 19.68"
 SP 25 cm / 9.84"
 H 40 cm / 15.74"

WW 12×E14×40 W (not included)
 USA 12×E12×40 W (not included)



RECTANGULAR

L 50 cm / 19.68"
 SP 25 cm / 9.84"
 H 60 cm / 23.62"

WW 12×E14×40 W (not included)
 USA 12×E12×40 W (not included)

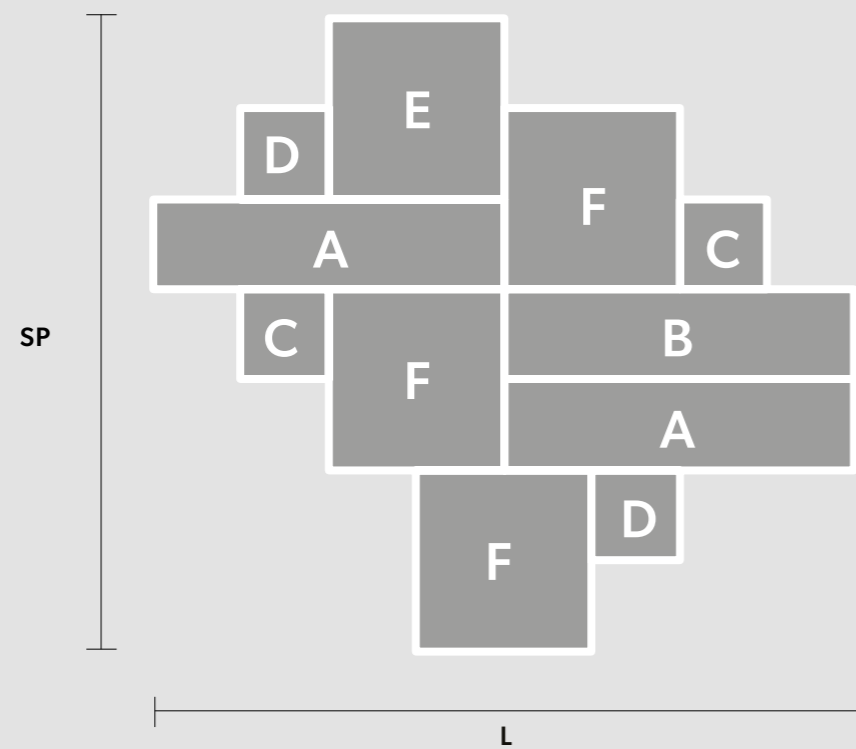
CUBO COMBO S 100 SQ



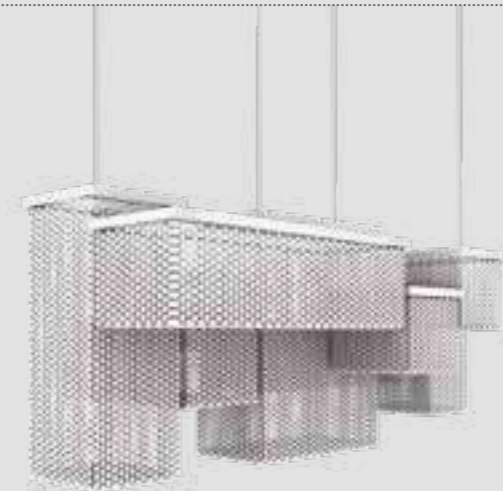
L 100 cm / 39.37" **WW** 48×E14×40 W (not included)
SP 100 cm / 39.37" **USA** 48×E12×40 W (not included)
H 80 cm / 31.49"

Composition

- A** 2 x Cubo S/Long/A
- B** 1 x Cubo S/Long/B
- C** 2 x Cubo S/Square/Small/40
- D** 2 x Cubo S/Square/Small/60
- E** 1 x Cubo S/Square/Medium/20
- F** 3 x Cubo S/Square/Medium/40



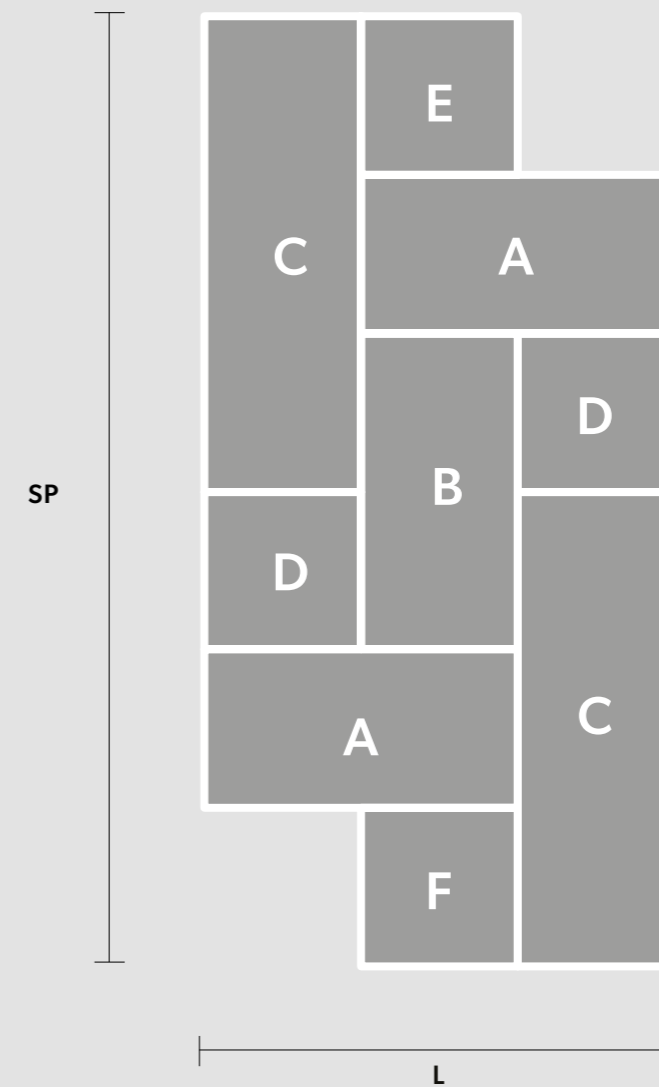
CUBO COMBO S 150 RC



L 75 cm / 29.52" **WW** 69×E14×40 W (not included)
SP 150 cm / 59.05" **USA** 69×E12×40 W (not included)
H 60 cm / 23.62"

Composition

- A** 2 x Cubo S/Long/J
- B** 1 x Cubo S/Long/L
- C** 2 x Cubo S/Long/M
- D** 2 x Cubo S/Square/Medium/20
- E** 1 x Cubo S/Square/Medium/40
- F** 1 x Cubo S/Square/Medium/60



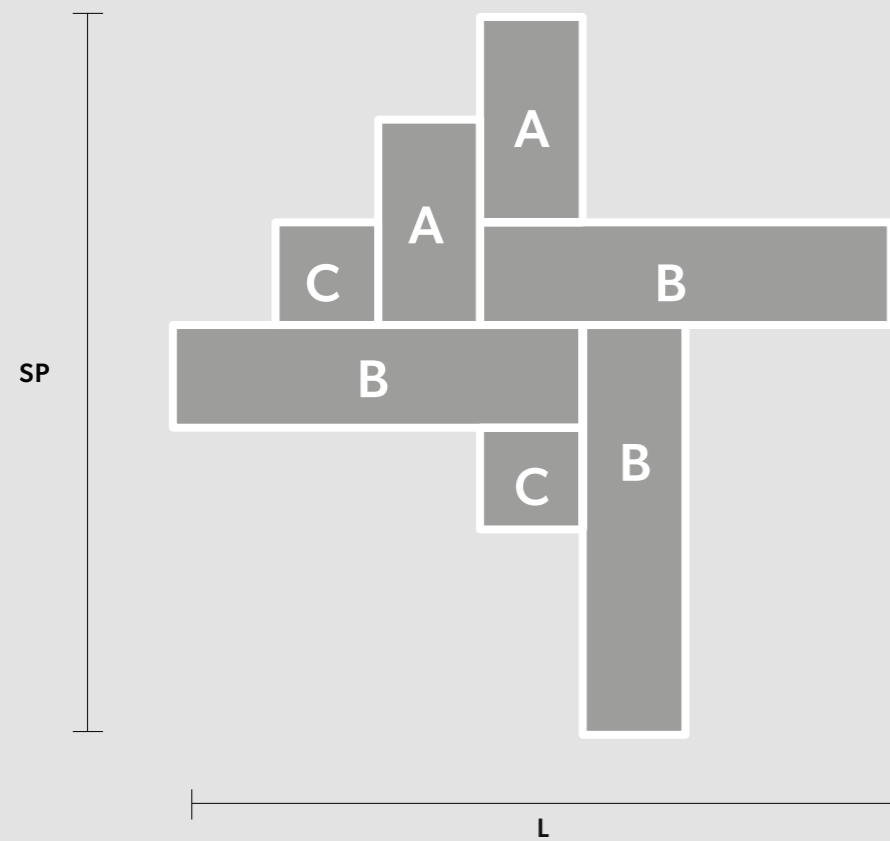
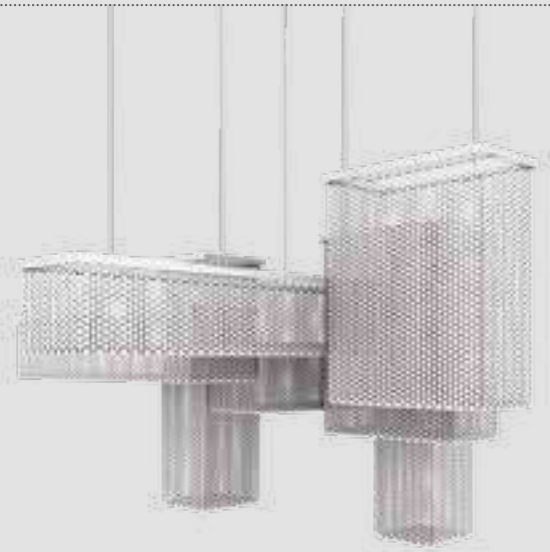
CUBO COMBO S 175 SQ



L 175 cm / 68.89" WW 80x14x40 W (not included)
 SP 175 cm / 68.89" USA 80x12x40 W (not included)
 H 100 cm / 39.37"

Composition

- A** 2 x Cubo/S/Long/L
- B** 3 x Cubo/S/Long/P
- C** 2 x Cubo/S/Square/Medium/80



CUBO COMBO S175 SQ

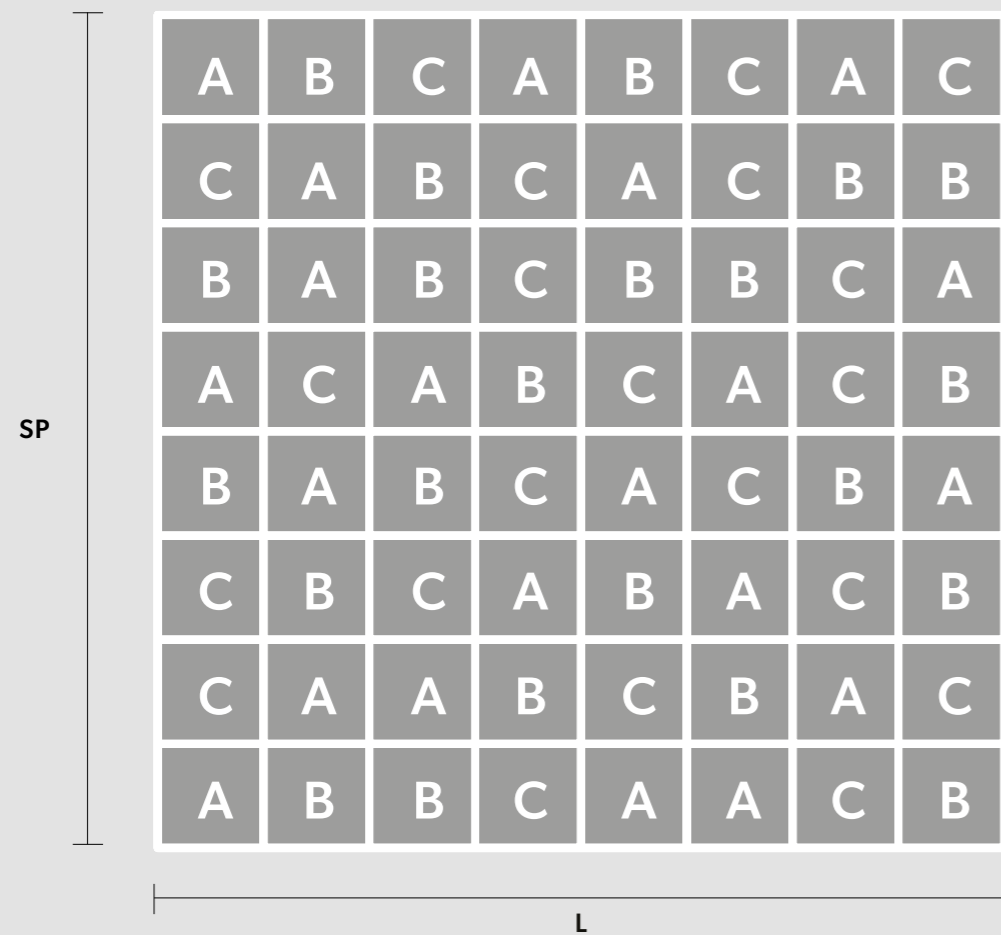
CUBO COMBO S 64 100 SQ



L 100 cm / 39.37" **WW** 106×E14×40 W (not included)
SP 100 cm / 39.37" **USA** 106×E12×40 W (not included)
H 600 cm / 236.22"

Composition

- A** 21 X Cubo S/Square/Small/20
- B** 22 X Cubo S/Square/Small/40
- C** 21 X Cubo S/Square/Small/60



CUBO COMBO S64 100 SQ

CUBO COMBO S12 200 SQ



L 200 cm / 78.74" **WW** 158×E14×40 W (not included)
SP 200 cm / 78.74" **USA** 158×E12×40 W (not included)
H 225 cm / 88.58"

Composition

- A** 3 x Cubo S/Long/K
- B** 2 x Cubo S/Long/N
- C** 1 x Cubo S/Long/O
- D** 1 x Cubo S/Long/Q
- E** 1 x Cubo S/Long/R
- F** 1 x Cubo S/Square/Medium/40
- G** 1 x Cubo S/Square/Medium/60
- H** 2 x Cubo S/Square/Medium/80



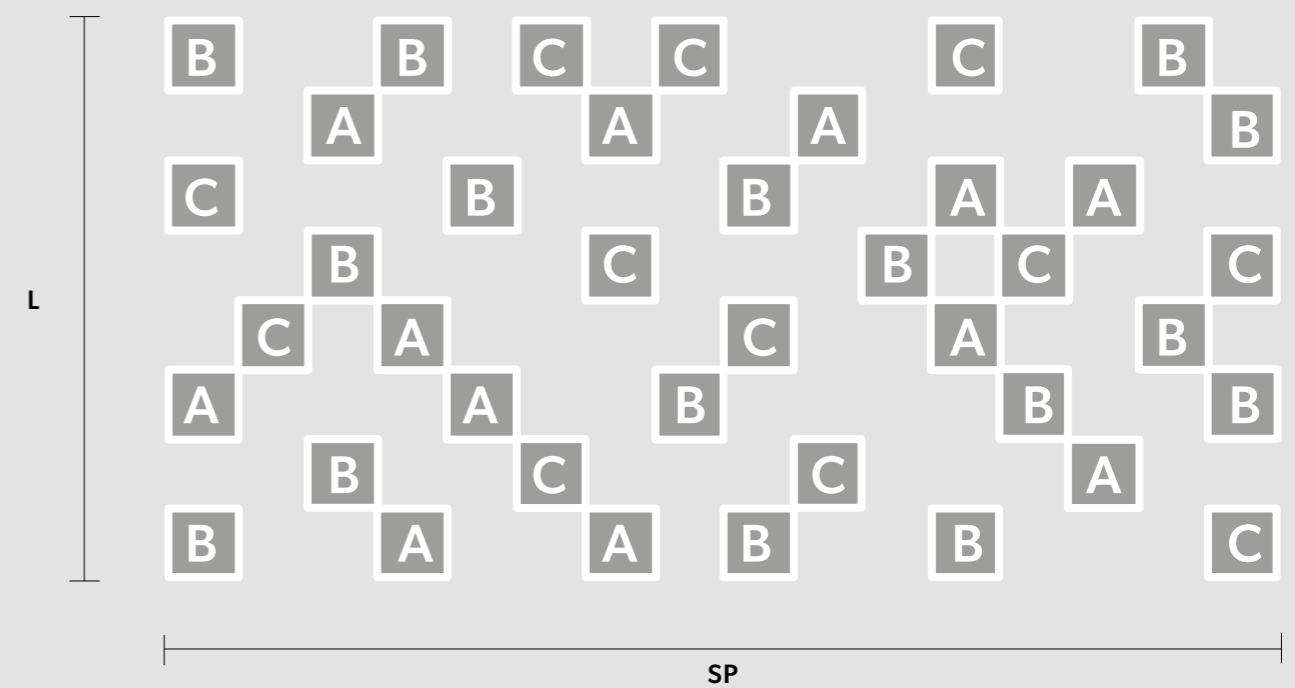
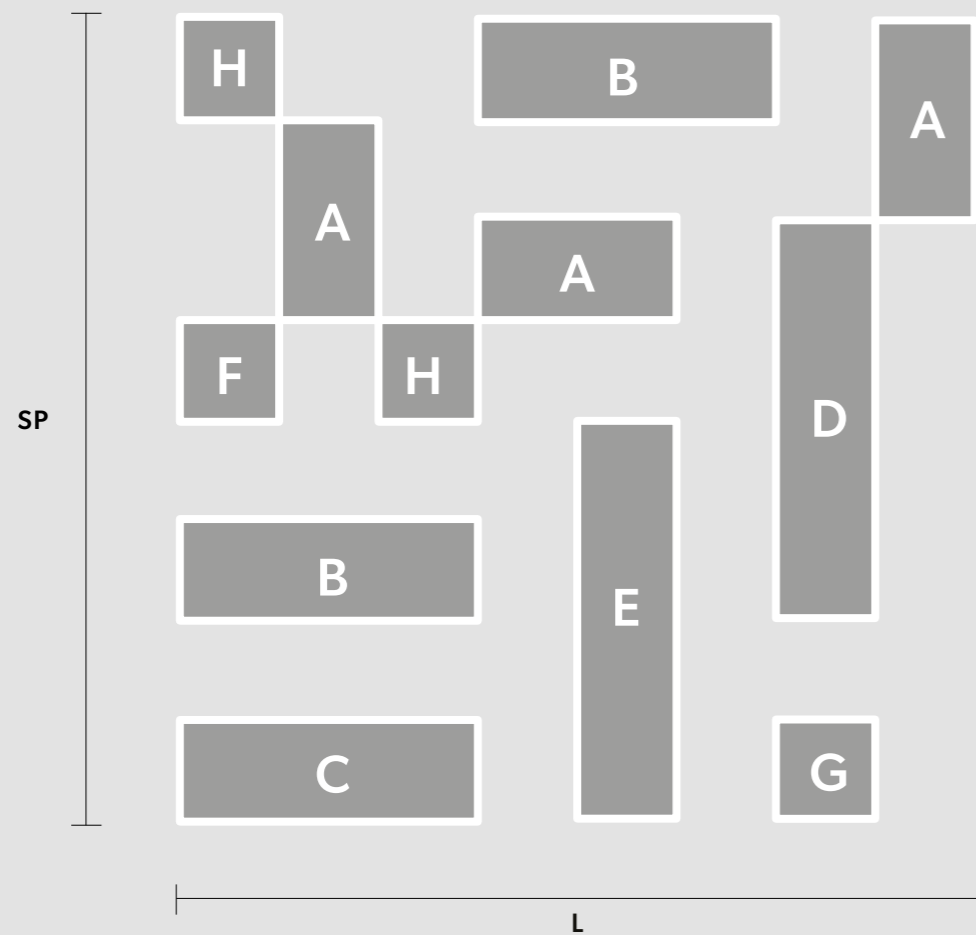
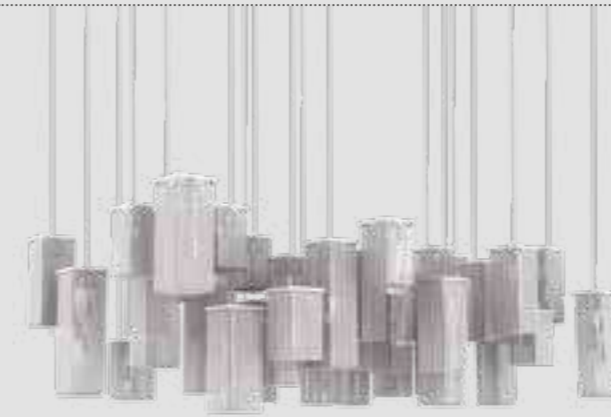
CUBO COMBO S 40 200 RC

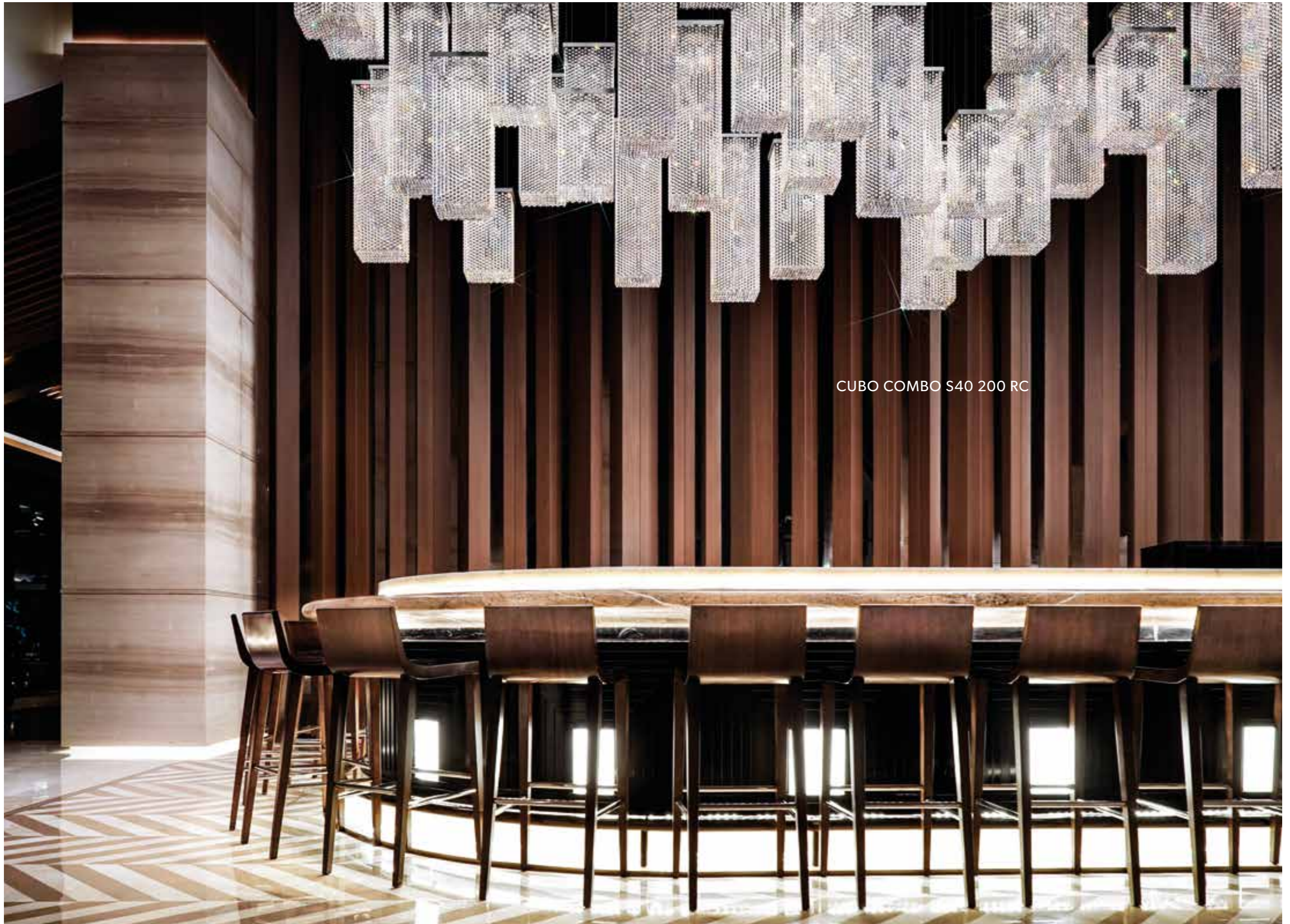


L 200 cm / 78.74" **WW** 332×E14×40 W (not included)
SP 400 cm / 157.48" **USA** 332×E12×40 W (not included)
H 140 cm / 55.12"

Composition

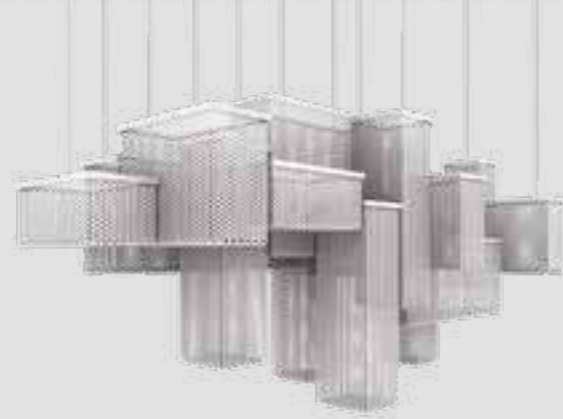
- A** 12 X Cubo S/Square/Medium/40
- B** 16 X Cubo S/Square/Medium/60
- C** 12 X Cubo S/Square/Medium/80





CUBO COMBO S40 200 RC

CUBO COMBO S300 RC

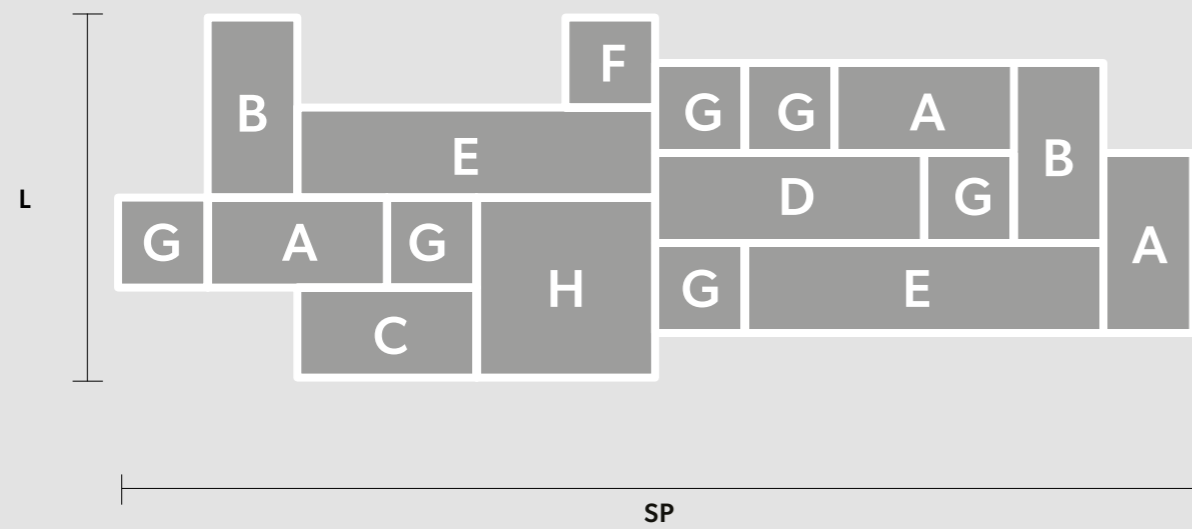


L 100 cm / 39.37"
SP 300 cm / 118.11"
H 120 cm / 47.24"

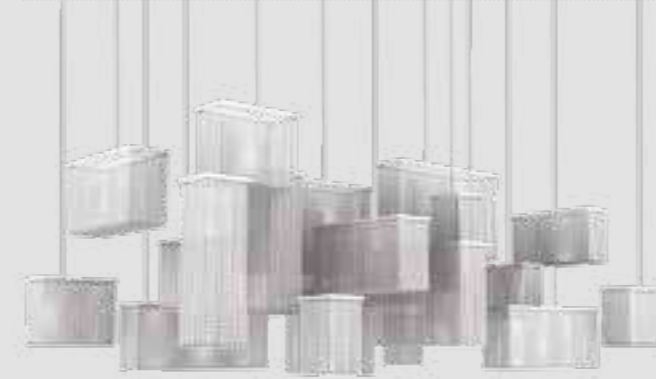
WW 192×E14×40 W (not included)
USA 192×E12×40 W (not included)

Composition

- A** 3 x Cubo/S/Long/J
- B** 2 x Cubo/S/Long/K
- C** 1 x Cubo/S/Long/L
- D** 1 x Cubo/S/Long/O
- E** 2 x Cubo/S/Long/Q
- F** 1 x Cubo/S/Square/Medium/40
- G** 6 x Cubo/S/Square/Medium/80
- H** 1 x Cubo/S/Square/Large/40



CUBO COMBO S 24 200 RC

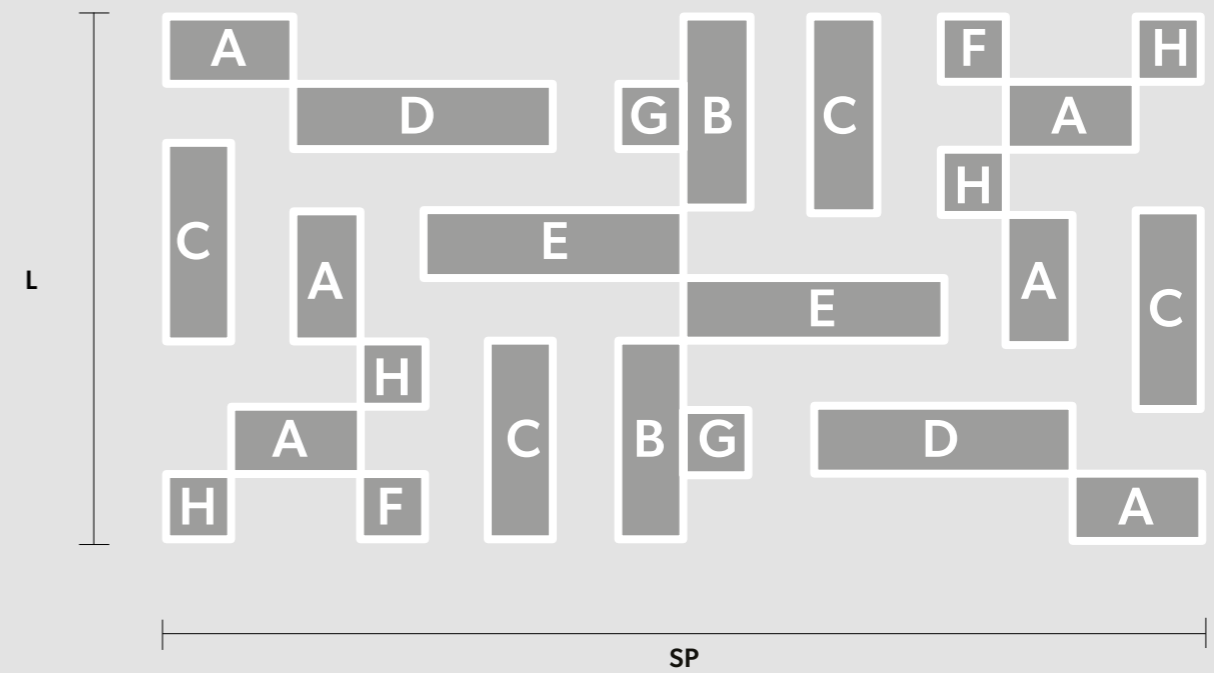


L 200 cm / 78.74"
SP 400 cm / 157.48"
H 145 cm / 57.08"

WW 316×E14×40 W (not included)
USA 316×E12×40 W (not included)

Composition

- A** 6 x Cubo/S/Long/K
- B** 2 x Cubo/S/Long/O
- C** 4 x Cubo/S/Long/N
- D** 2 x Cubo/S/Long/Q
- E** 2 x Cubo/S/Long/R
- F** 2 x Cubo/S/Square/Medium/40
- G** 2 x Cubo/S/Square/Medium/60
- H** 4 x Cubo/S/Square/Medium/80



CUBO FINISHING

Struttura in metallo in finitura cromo e pendagli in cristallo trasparente o colorato.

Metal frame in chrome finishing with transparent or coloured crystal pendants.

Metallstruktur, Ausführung Chrom. Anhänger aus transparentem oder farbigem Kristall.

Structure en métal chromé, pampilles en cristal transparent ou coloré.

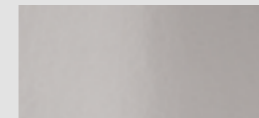
МЕТАЛЛИЧЕСКАЯ СТРУКТУРА, В ОТДЕЛКЕ ХРОМ, С ПОДВЕСКАМИ ИЗ ПРОЗРАЧНОГО ИЛИ ЦВЕТНОГО КРИСТАЛЛА.

Estructura metálica en acabado cromado y colgantes de cristal transparente o coloreado.

这种灯具有金属结构 (铬色), 而且水晶的吊坠们 (有色的和透明的)。

إطار معدني بلمسات نهائية من الكروم مع دلايات كريستال شفافة أو ملونة.

Finishings



G04 Cromo lucido
Shiny chrome

Pendants

TRANSPARENT
Half cut glass /
Cut crystal /
Crystals from Swarovski®



TR Trasparente
Transparent

COLOURED
Half cut glass /
Cut crystal



SA Sapphire



VI Viola
Violet



GR Light Peridot



AM Ambra
Amber



RE Rosso
Red



SM Fumé
Smocky

GALASSIA

design by Masiero Lab

Galassia rappresenta una nuova era dei sistemi illuminanti modulari a soffitto.

Grazie alla combinazione dei moduli è possibile decorare qualsiasi superficie, creando forme aperte o chiuse dalle quali scenderanno piogge di pendagli.

Galassia represents a new era of modular ceiling lighting systems.

The modules can be combined to decorate any surface, creating open or closed shapes with showers of hanging pendants.



GALASSIA T2 SNG

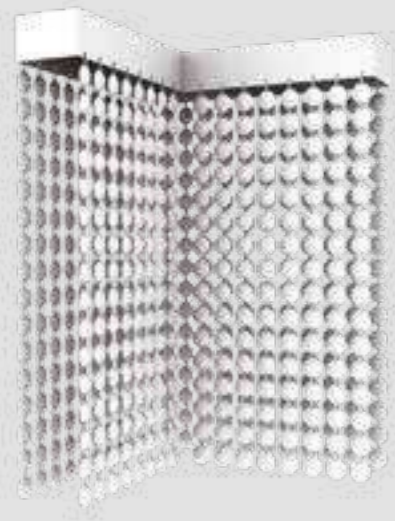
GALASSIA CEILING MODULES

Galassia is a modular LED ceiling system with remote driver, consisting of a combination of angular, arched or straight metal modules with chains of hanging pendants that allow the height to be adjusted. There are seven arched modules, two straight modules and a corner module that can

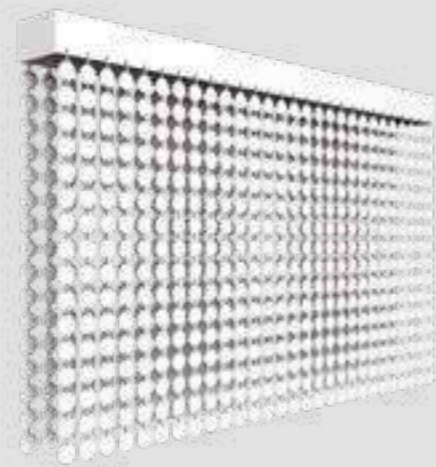
be combined into an infinite number of solutions to create the desired lighting path to decorate surfaces of any shape.

Compositions with open or closed lines can be created.

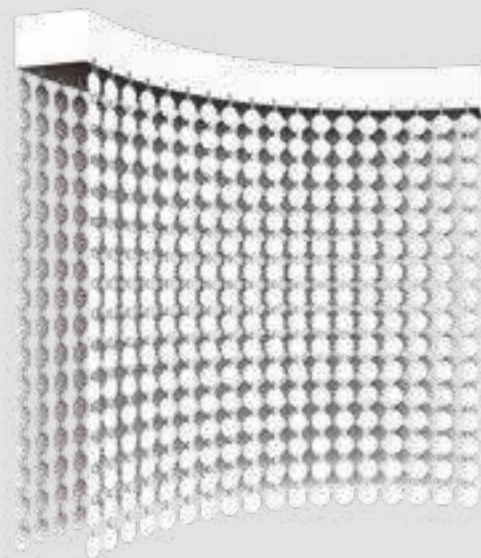
CORNER MODULE



STRAIGHT MODULES



CURVED MODULES



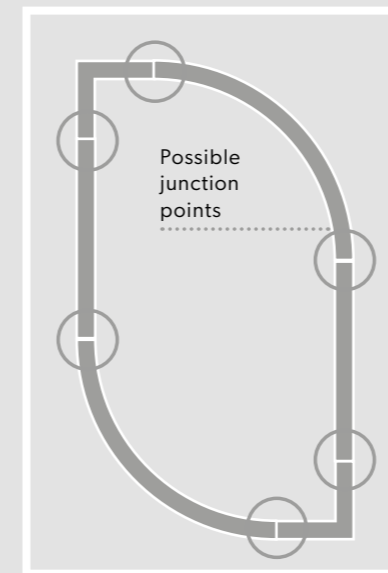
DECORABLE AREAS

Galassia can be used to decorate any area

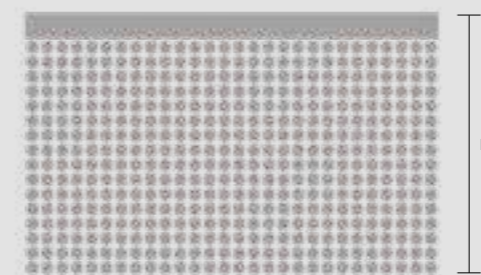


HOW TO ARRANGE THE MODULES

The modules can create open or closed lines. In this case, they must be positioned in such a way as to ensure junction points.



HEIGHT

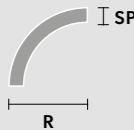





H	Min	25 cm / 9.84"
	Max	100 cm / 7.87"

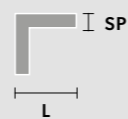
You can customise the height of the product by choosing the length of the pendants chains.

MODULES

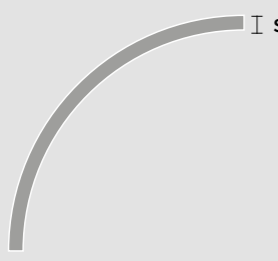


Curved Modules



ARCH 50	ARCH 75	ARCH 100	ARCH 125
			
R 25 cm / 9.84"	R 38 cm / 14.96"	R 50,5 cm / 19.88"	R 63 cm / 24.80"
SP 4,7 cm / 1.85"	SP 4,7 cm / 1.85"	SP 4,7 cm / 1.85"	SP 4,7 cm / 1.85"
H Frame 3 cm / 1.18"	H Frame 3 cm / 1.18"	H Frame 3 cm / 1.18"	H Frame 3 cm / 1.18"
*H Pendants Chain min. 25 cm / 9.84" max. 100 cm / 39.37"	*H Pendants Chain min. 25 cm / 9.84" max. 100 cm / 39.37"	*H Pendants Chain min. 25 cm / 9.84" max. 100 cm / 39.37"	*H Pendants Chain min. 25 cm / 9.84" max. 100 cm / 39.37"
LED X 4,2W CRI>95 3000K - 540 Nominal lumen	LED X 6W CRI>95 3000K - 772 Nominal lumen	LED X 8W CRI>95 3000K - 1081 Nominal lumen	LED X 11W CRI>95 3000K - 1390 Nominal lumen

Corner Module

CORNER 20X20

L 19,7 cm / 7.75"
SP 4,7 cm / 1.85"
H Frame 3 cm / 1.18"
*H Pendants Chain min. 25 cm / 9.84" max. 100 cm / 39.37"
LED X 3,6W CRI>95 3000K - 463 Nominal lumen

Straight Modules

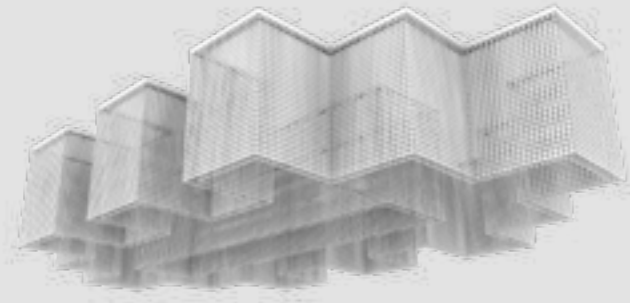
ARCH 150	ARCH 175	ARCH 200
		
R 76 cm / 29.92"	R 88 cm / 34.64"	R 101 cm / 39.76"
SP 4,7 cm / 1.85"	SP 4,7 cm / 1.85"	SP 4,7 cm / 1.85"
H Frame 3 cm / 1.18"	H Frame 3 cm / 1.18"	H Frame 3 cm / 1.18"
*H Pendants Chain min. 25 cm / 9.84" max. 100 cm / 39.37"	*H Pendants Chain min. 25 cm / 9.84" max. 100 cm / 39.37"	*H Pendants Chain min. 25 cm / 9.84" max. 100 cm / 39.37"
LED X 13W CRI>95 3000K - 1700 Nominal lumen	LED X 15W CRI>95 3000K - 2008 Nominal lumen	LED X 18W CRI>95 3000K - 2317 Nominal lumen

STRAIGHT 100	STRAIGHT 50
	
L 101 cm / 39.76"	L 50,5 cm / 19.88"
SP 4,7 cm / 1.85"	SP 4,7 cm / 1.85"
H Frame 3 cm / 1.18"	H Frame 3 cm / 1.18"
*H Pendants Chain min. 25 cm / 9.84" max. 100 cm / 39.37"	*H Pendants Chain min. 25 cm / 9.84" max. 100 cm / 39.37"
LED X 12W CRI>95 3000K - 1545 Nominal lumen	LED X 6W CRI>95 3000K - 772 Nominal lumen

*You can customise the height of the product by choosing the length of the pendants chains.

*You can customise the height of the product by choosing the length of the pendants chains.

GALASSIA M1 TPL



L 319 cm / 125.59"
SP 180 cm / 70.86"
H 50 cm / 19.68"
W 130 kg / 286.60 lb

LED x 180W CRI>95 3000K -
 23154 Nominal lumen
Dimmable: 1-10V
 (1 x driver recessed)

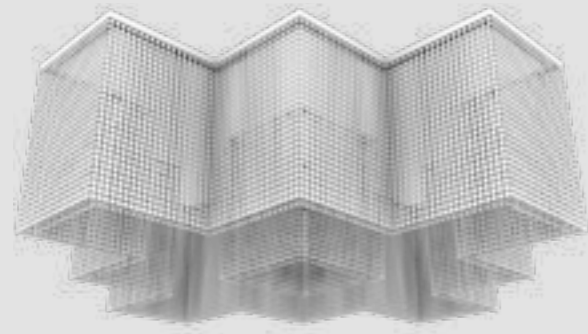
Composition :

- A** Outside
36 x Corner 20x20
- B** Inside
4 x Corner 20x20
2 x Straight 100
2 x Straight 50



GALASSIA M1 TPL COMPOSITION

GALASSIA M1 SNG

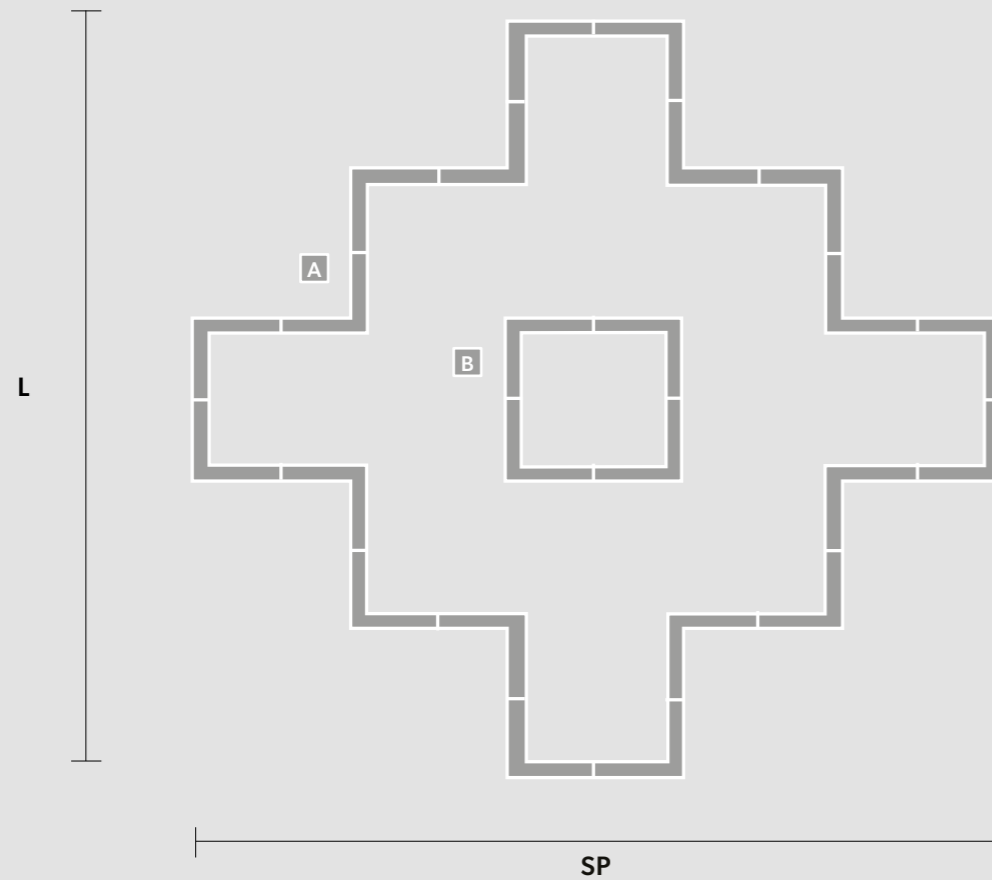


L 180 cm / 70.86"
SP 180 cm / 70.86"
H 50 cm / 19.68"
W 70 kg / 154.32 lb

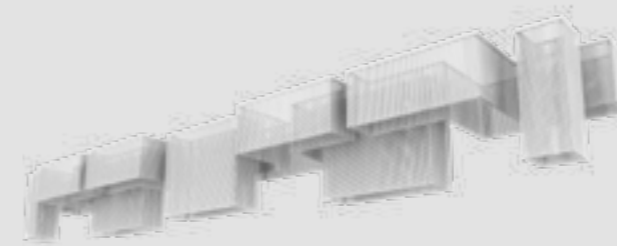
LED x 86,4 W CRI>95 3000K -
 11112 Nominal lumen
Dimmable: 1-10V
 (1 x driver recessed)

Composition :

- A** Outside
20 x Corner 20x20
- B** Inside
4 x Corner 20x20



GALASSIA N1 DBL

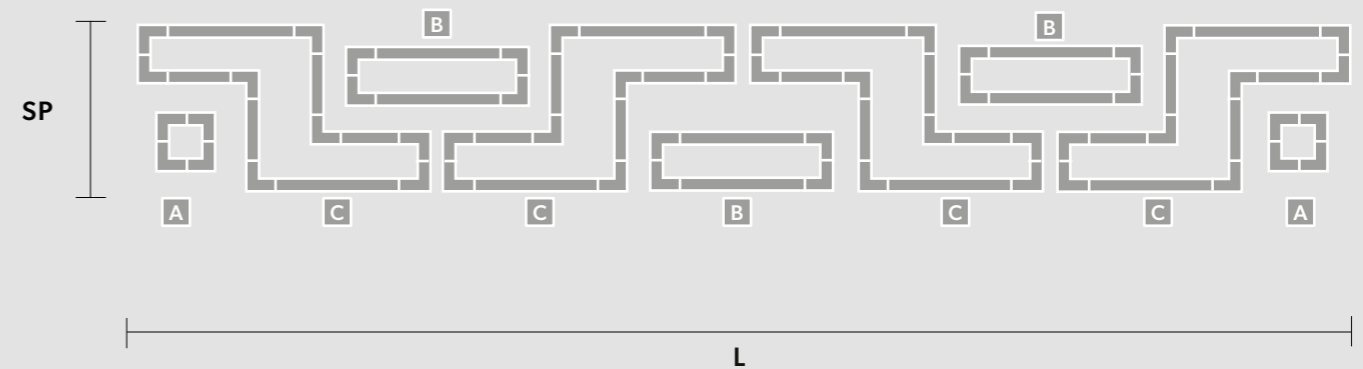


L 945 cm / 372.04"
SP 125 cm / 49.21"
H 100 cm / 39.37"
W 370 kg / 815.71 lb

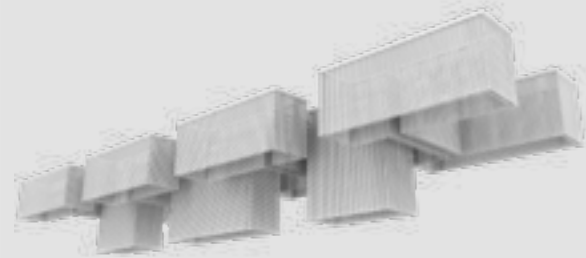
LED x 451,2 W CRI>95 3000K -
 58092 Nominal lumen
Dimmable: 1-10V
 (2 x driver recessed)

Composition :

- A** Combo A H100 (x2)
4 x Corner 20x20
- B** Combo B H100 (x3)
4 x Corner 20x20
2 x Straight 100
- C** Combo C H50 (x4)
8 x Corner 20x20
2 x Straight 100
4 x Straight 50



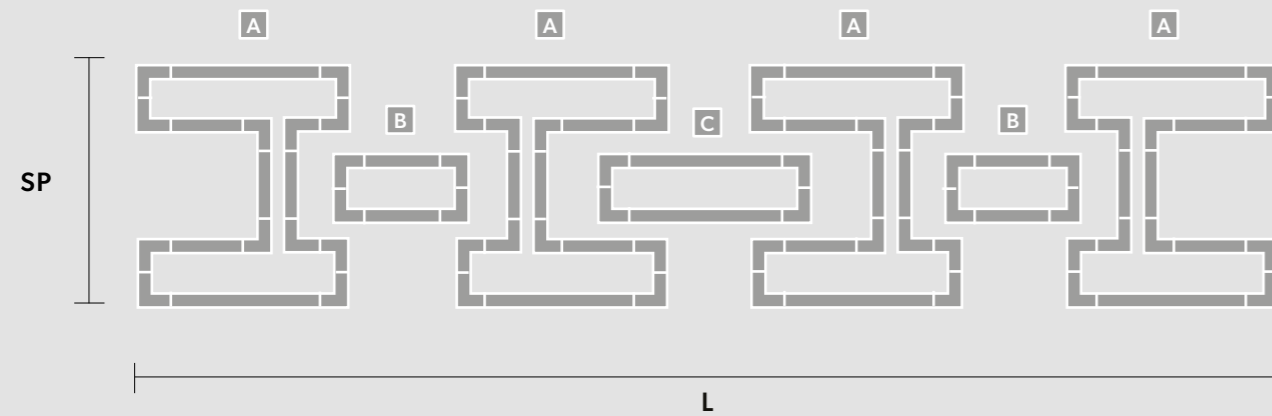
GALASSIA N2 DBL



L	700 cm / 275.59"	LED x 456W CRI>95 3000K -
SP	160 cm / 62.99"	58710 Nominal lumen
H	100 cm / 39.37"	Dimmable: 1-10V
W	350 kg / 771.61 lb	(2 x driver recessed)

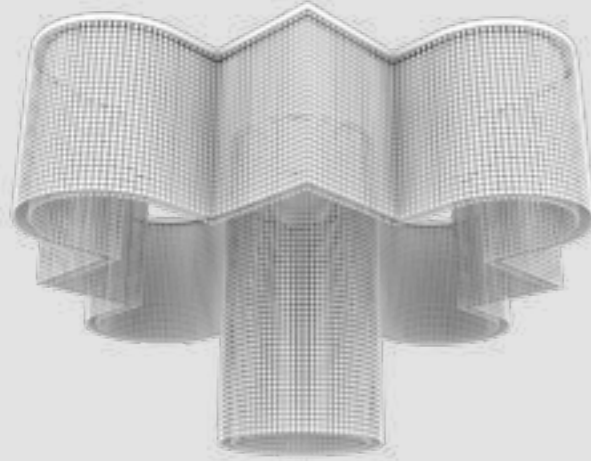
Composition :

- A** Combo A H50 (x4)
12 x Corner 20x20
2 x Straight 100
4 x Straight 50
- B** Combo B H100 (x2)
4 x Corner 20x20
2 x Straight 50
- C** Combo C H100 (x1)
4 x Corner 20x20
2 x Straight 100



GALASSIA N2 DBL COMPOSITION

GALASSIA O1 SNG

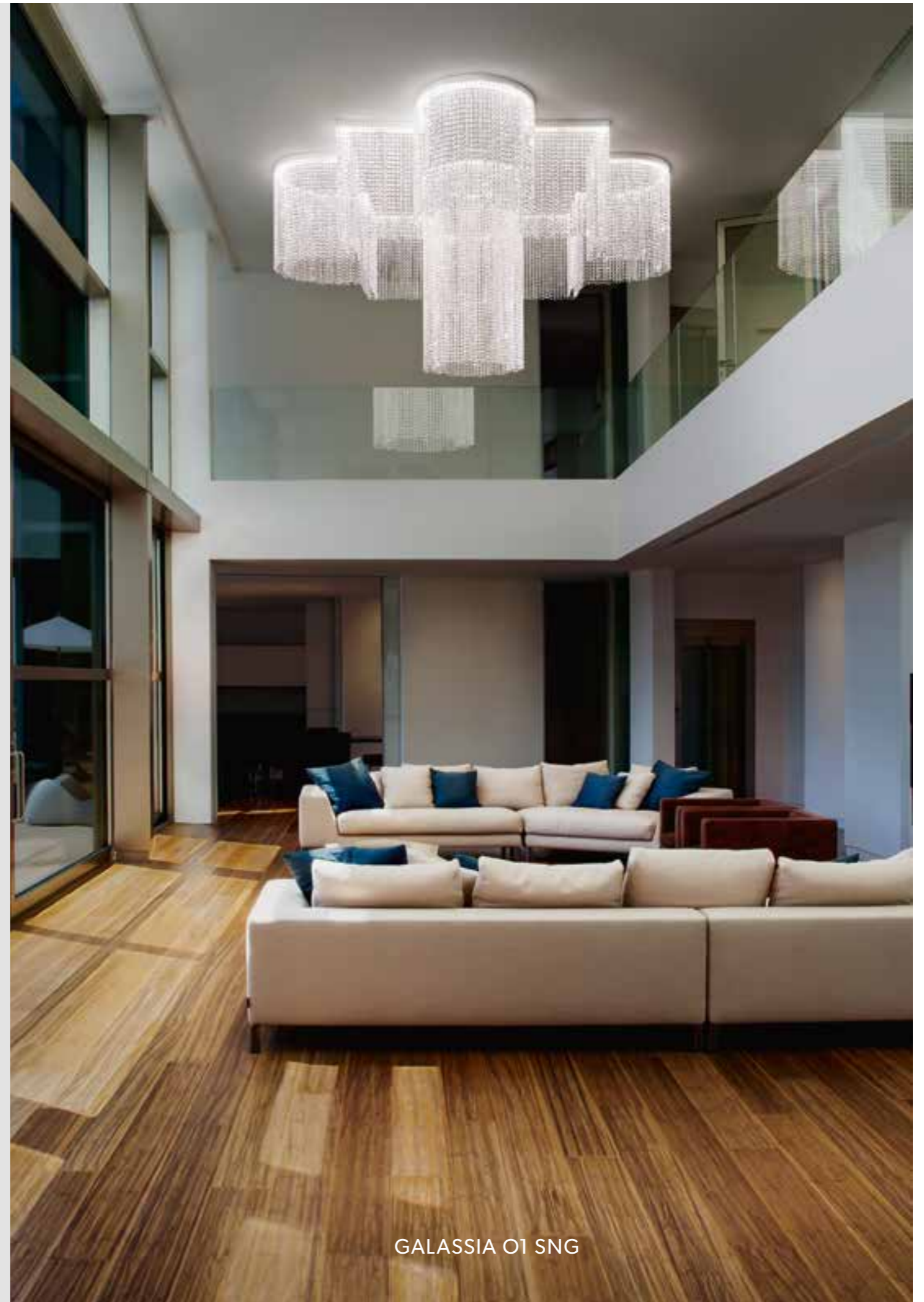
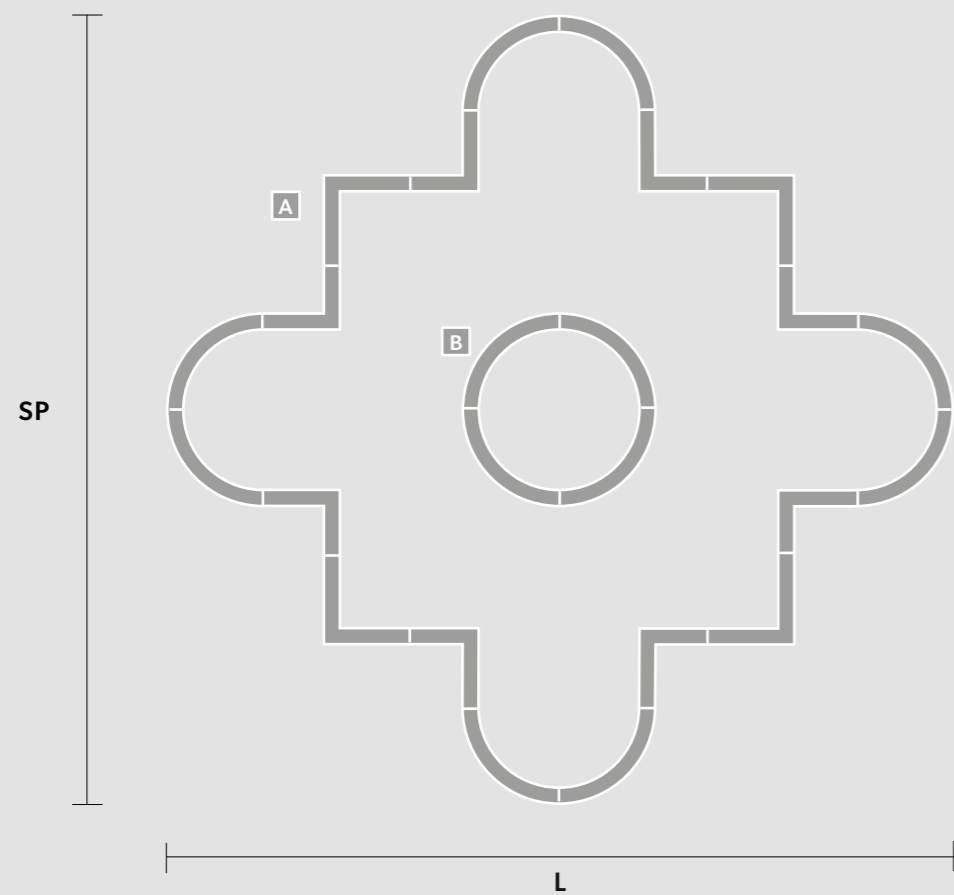


L 201 cm / 79.13"
SP 201 cm / 79.13"
H 100 cm / 39.37"
W 80 kg / 176.37 lb

LED x 93,6W CRI>95 3000K -
 12051 Nominal lumen
Dimmable: 1-10V
 (1 x driver recessed)

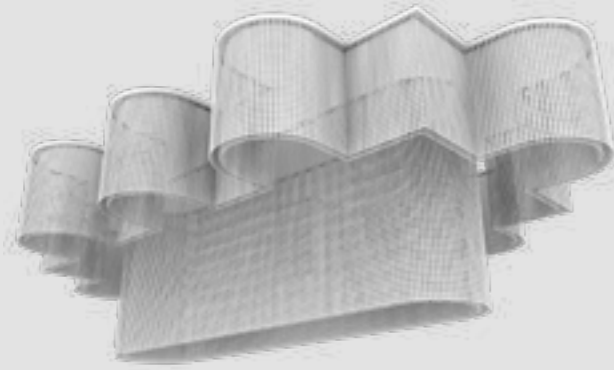
Composition :

- A** Outside H50
12 x Corner 20x20
8 x Arch 50
- B** Inside H100
4 x Arch 50



GALASSIA O1 SNG

GALASSIA 01 TPL

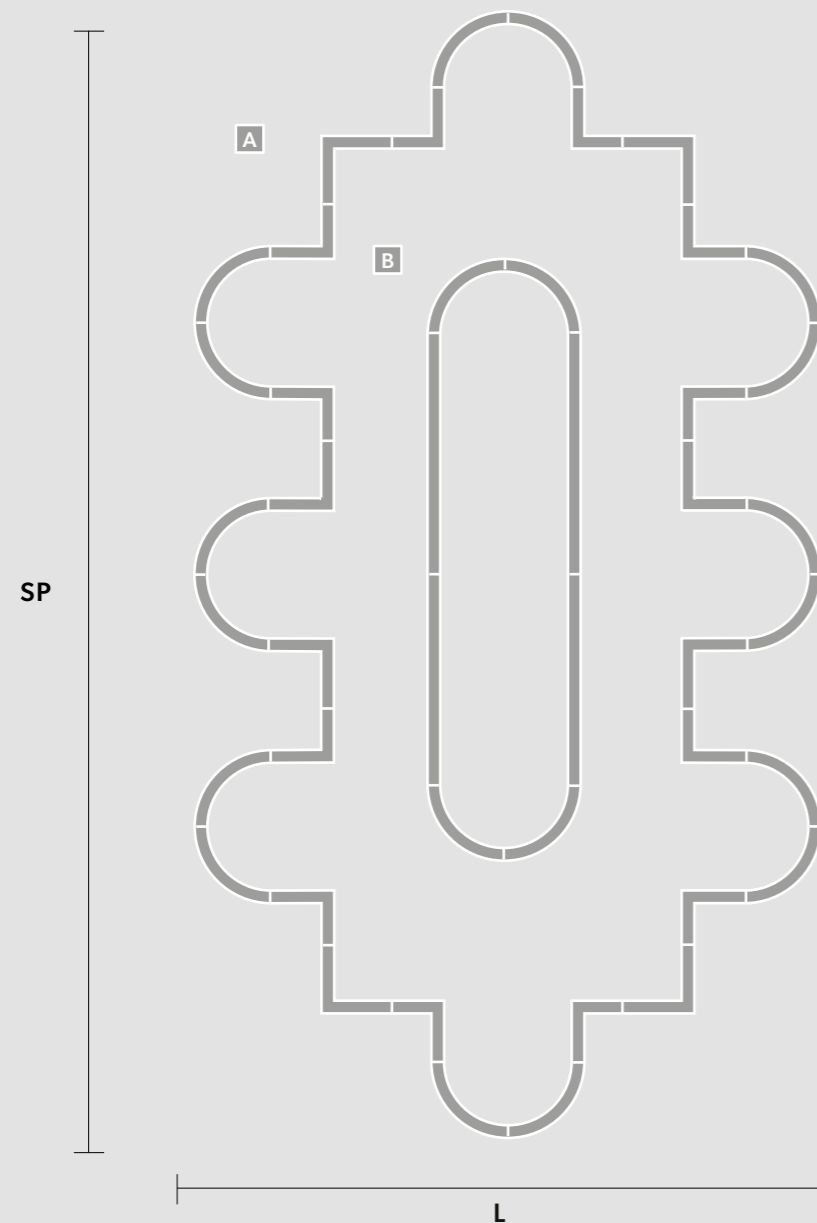


L 362 cm / 142.51"
SP 201 cm / 79.13"
H 100 cm / 39.37"
W 170 kg / 374.78 lb

LED x 204W CRI>95 3000K -
 26265 Nominal lumen
Dimmable: 1-10V
 (2 x drivers recessed)

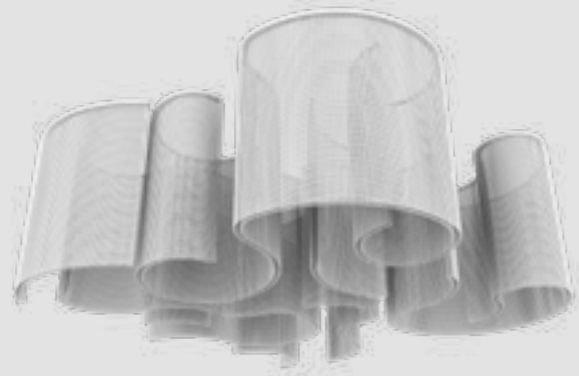
Composition :

- A** Outside H50
 20 x Corner 20x20
 16 x Arch 50
- B** Inside H100
 4 x Arch 50
 4 x Straight 100



GALASSIA 01 TPL

GALASSIA T1 SNG

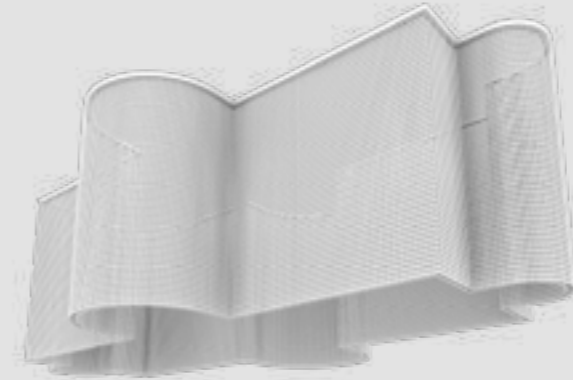


L 320 cm / 125.98"
SP 320 cm / 125.98"
H 50 cm / 19.68"
W 160 kg / 352.74 lb

LED x 237,8W CRI>95 3000K -
 30616 Nominal lumen
Dimmable: 1-10V
 (1 x driver recessed)

Composition :
 9 x Arch 50
 13 x Arch 75
 3 x Arch 100
 4 x Arch 125
 3 x Arch 150
 1 x Arch 175

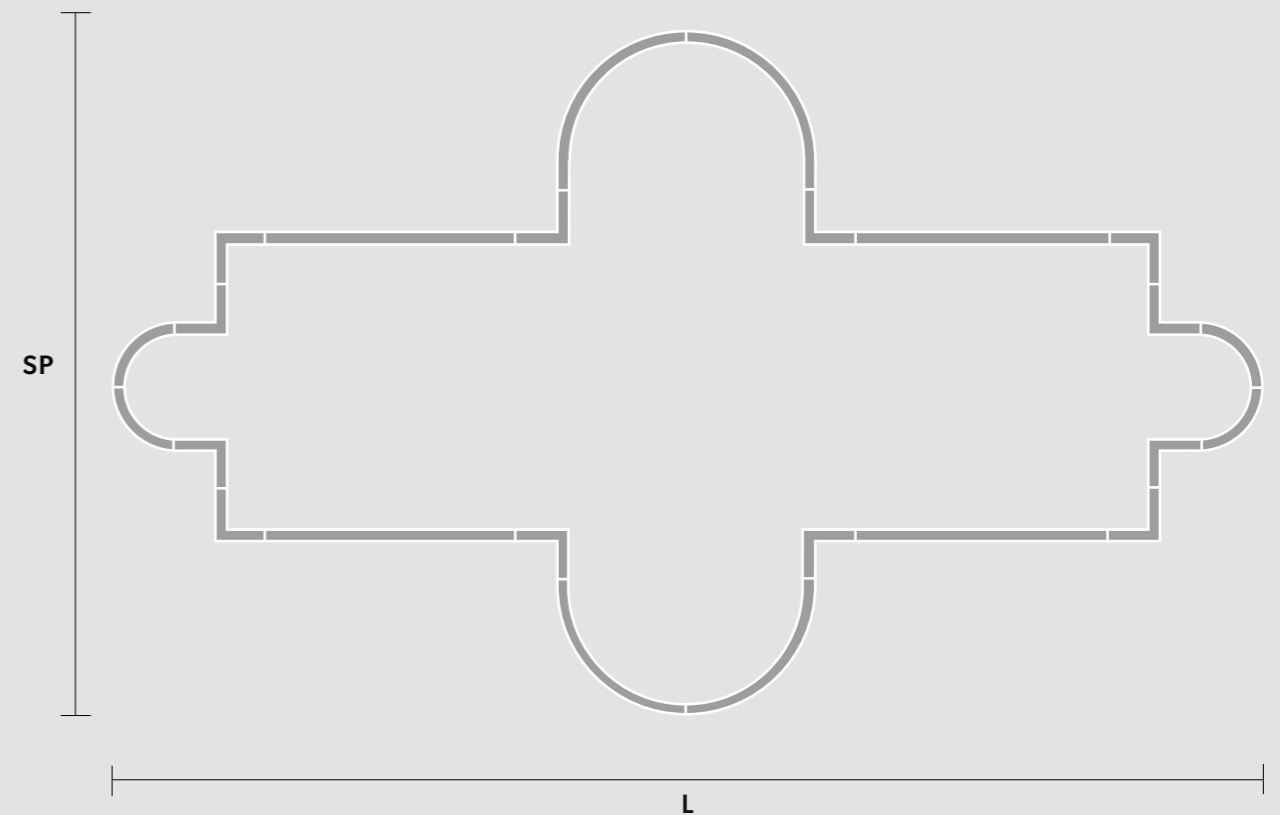
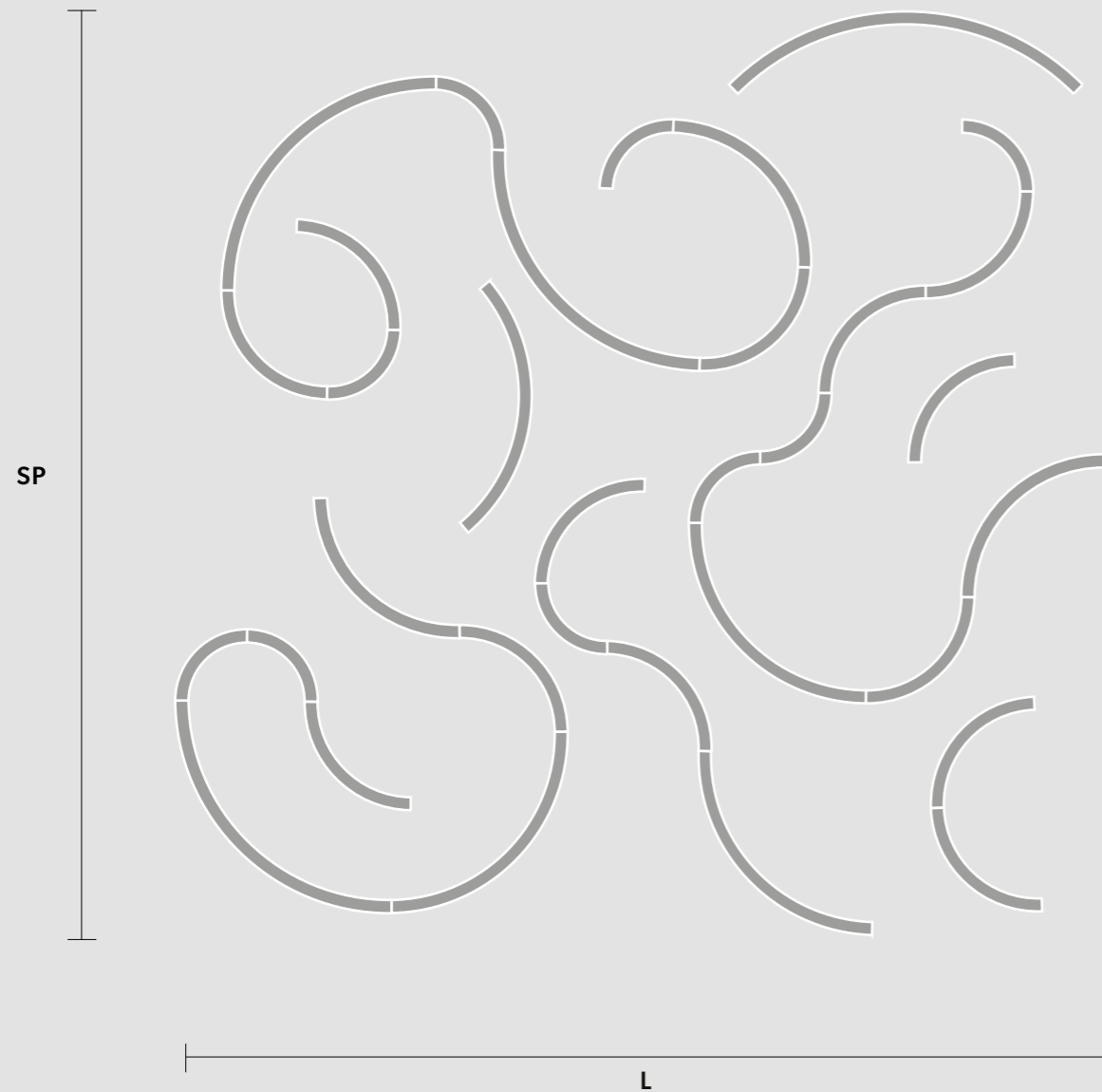
GALASSIA 02 DBL



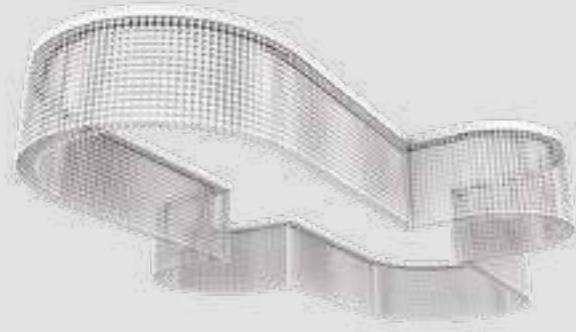
L 453 cm / 178.34"
SP 252 cm / 99.21"
H 100 cm / 39.37"
W 170 kg / 374.78 lb

LED x 140W CRI>95 3000K -
 17922 Nominal lumen
Dimmable: 1-10V
 (1 x driver recessed)

Composition :
 12 x Corner 20x20
 4 x Straight 100
 4 x Arch 50
 4 x Arch 100



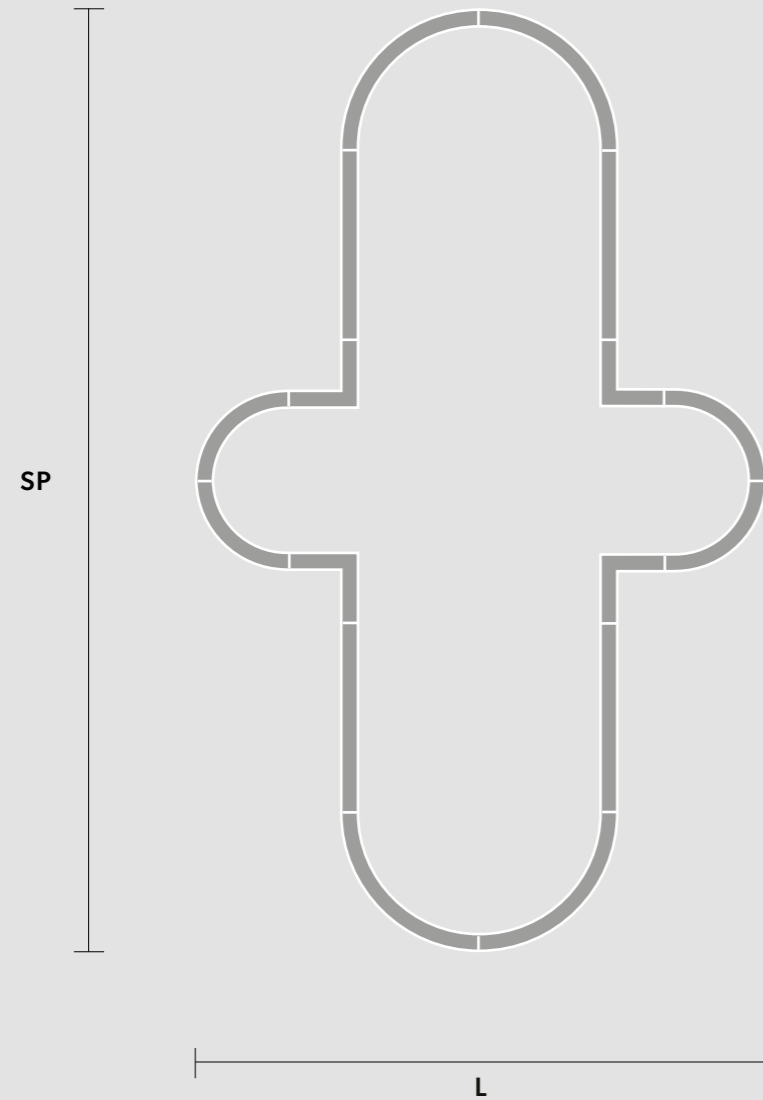
GALASSIA O3 SNG



L 257 cm / 101.18"
SP 156 cm / 61.41"
H 25 cm / 9.84"
W 40 kg / 88.18 lb

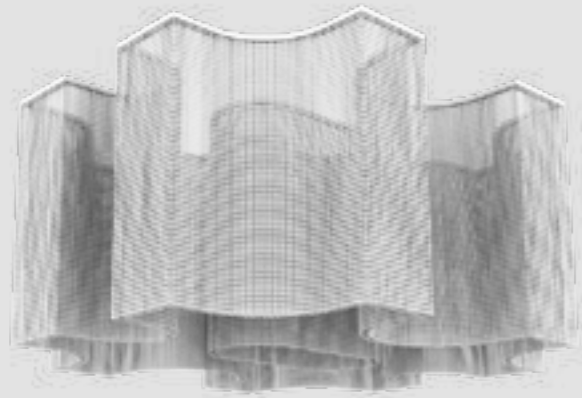
LED x 79,2W CRI>95 3000K -
 10197 Nominal lumen
Dimmable: 1-10V
 (1 x driver recessed)

Composition :
 4 x Corner 20x20
 4 x Straight 50
 4 x Arch 50
 4 x Arch 75



GALASSIA O3 SNG

GALASSIA P1 SNG

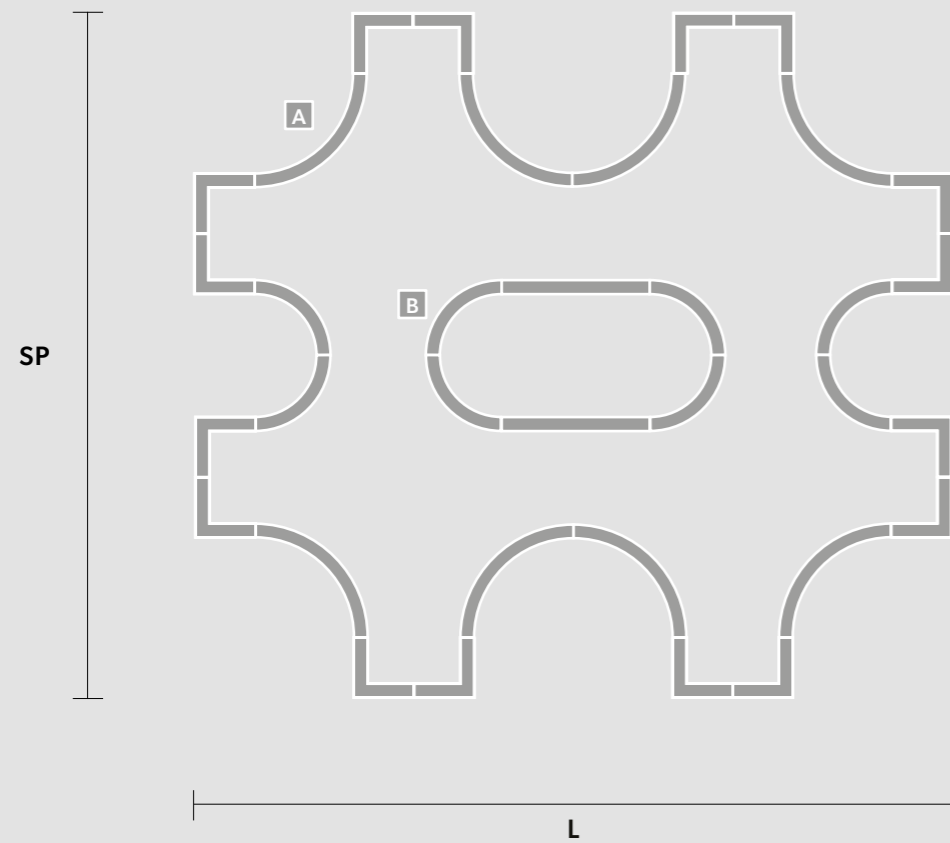


L 252 cm / 99.21"
SP 226 cm / 88.97"
H 50 cm / 19.68"
W 110 kg / 242.50 lb

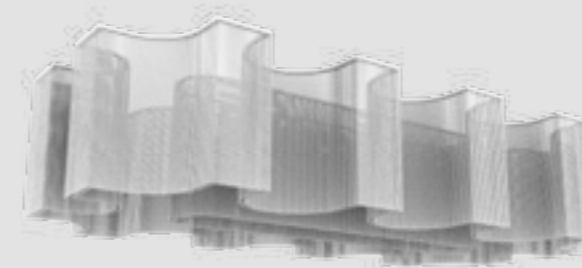
LED x 151,2W CRI>95 3000K -
 19467 Nominal lumen
Dimmable: 1-10V
 (1 x driver recessed)

Composition :

- A** Outside H50
16 x Corner 20x20
4 x Arch 50
8 x Arch 75
- B** Inside H50
2 x Straight 50
4 x Arch 50



GALASSIA P1 DBL



L 464 cm / 182.67"
SP 226 cm / 88.97"
H 50 cm / 19.68"
W 190 kg / 418.87 lb

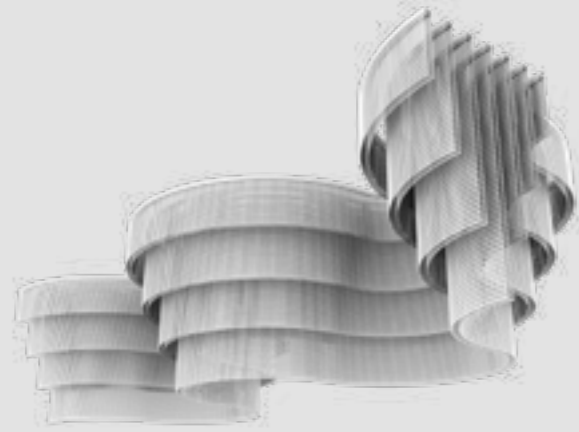
LED x 276W CRI>95 3000K -
 35535 Nominal lumen
Dimmable: 1-10V
 (1 x driver recessed)

Composition :

- A** Outside H50
24 x Corner 20x20
4 x Arch 50
16 x Arch 75
- B** Inside H50
2 x Straight 50
4 x Straight 100
4 x Arch 50



GALASSIA R1 DBL

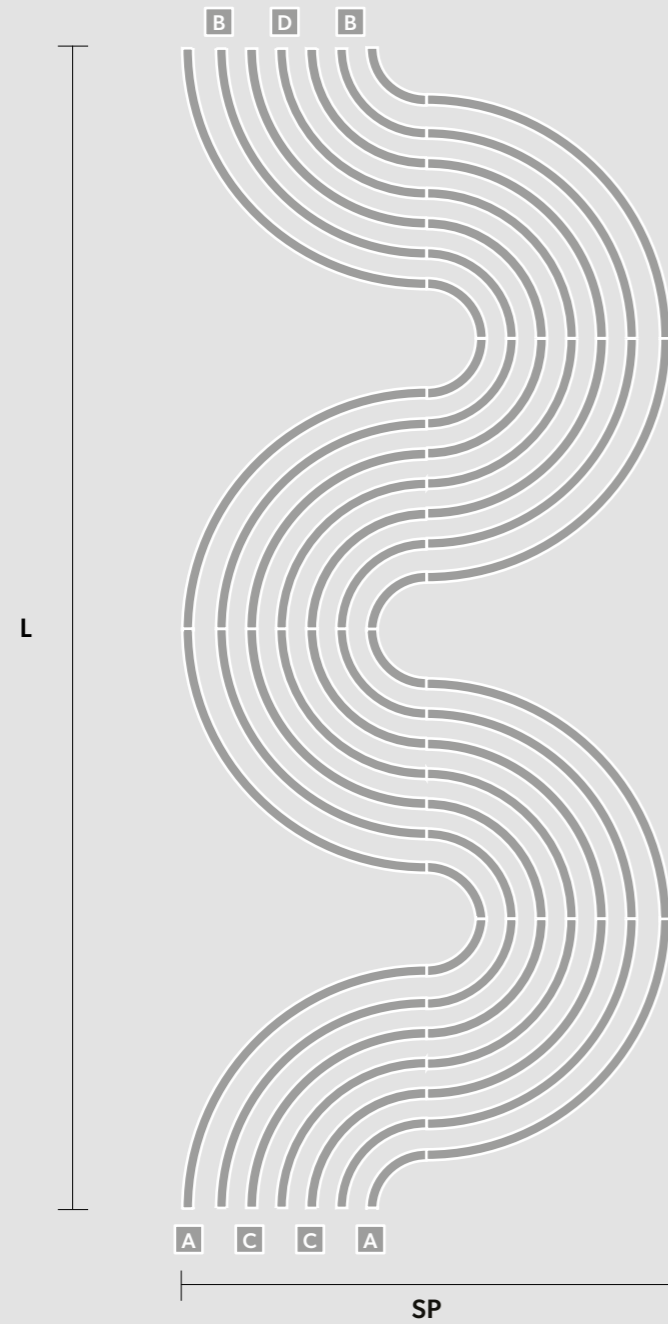


L 486 cm / 191.33"
SP 202 cm / 79.52"
H 100 cm / 39.37"
W 440 kg / 970.03 lb

LED x 601,6W CRI>95 3000K -
 77404 Nominal lumen
Dimmable: 1-10V
 (2 x drivers recessed)

Composition :

- A** Combo A H25
8 x Arch 200
8 x Arch 50
- B** Combo B H50
8 x Arch 175
8 x Arch 75
- C** Combo C H75
8 x Arch 150
8 x Arch 100
- D** Combo D H100
8 x Arch 125



GALASSIA R1 DBL COMPOSITION

GALASSIA Q1 SNG

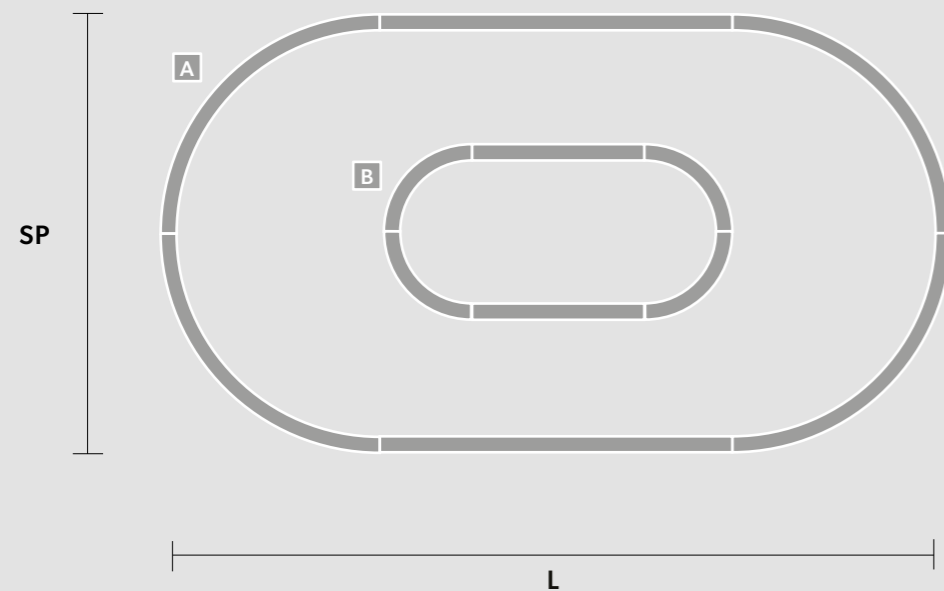


L 227 cm / 89.37"
SP 126 cm / 49.60"
H 100 cm / 39.37"
W 80 kg / 176.37 lb

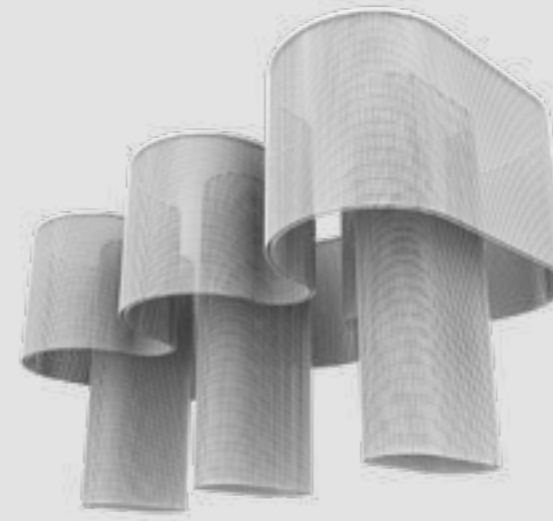
LED x 96,8W CRI>95 3000K -
 12462 Nominal lumen
Dimmable: 1-10V
 (1 x driver recessed)

Composition :

- A** Outside H50
4 x Arch 125
2 x Straight 100
- B** Inside H100
4 x Arch 50
2 x Straight 50



GALASSIA Q1 TPL

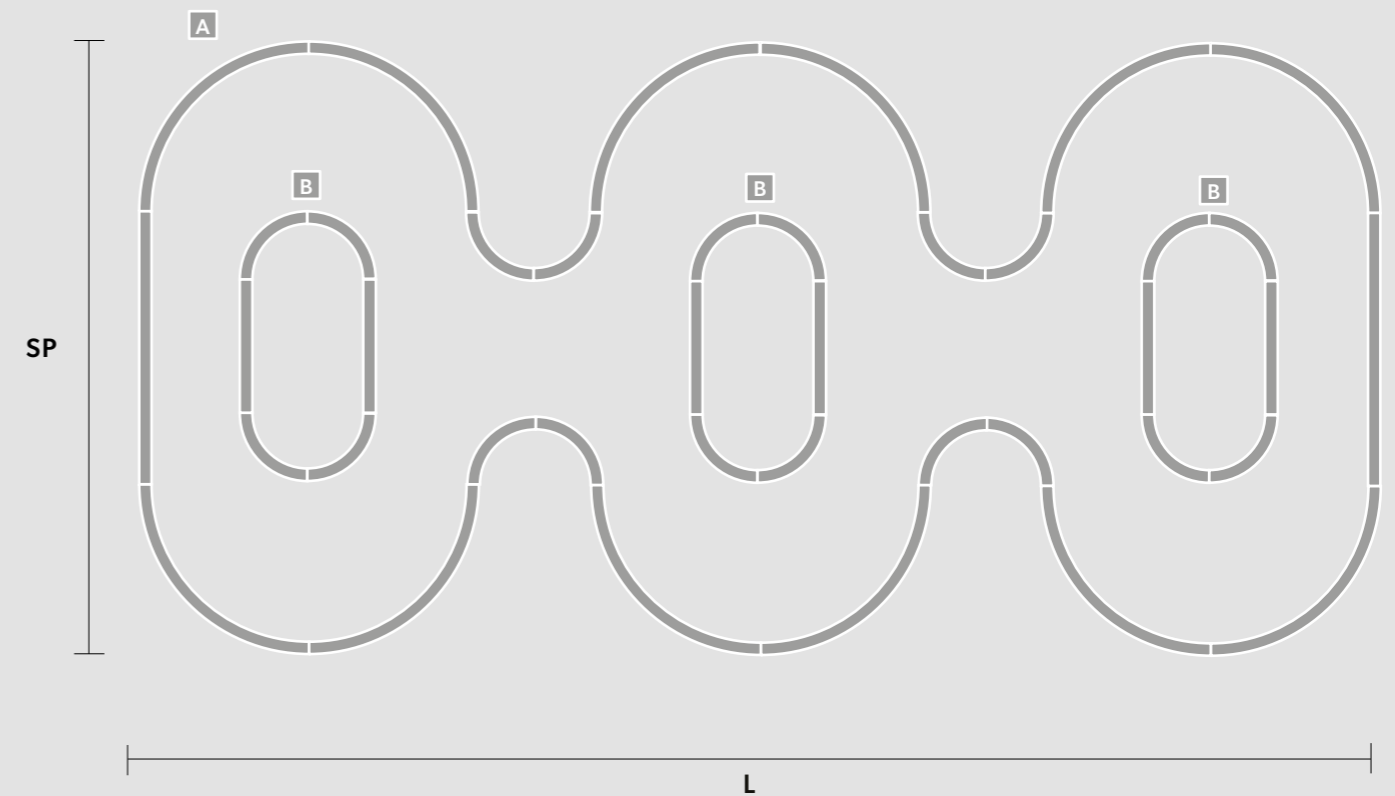


L 461 cm / 181.49"
SP 227 cm / 89.37"
H 100 cm / 39.37"
W 220 kg / 485.01 lb

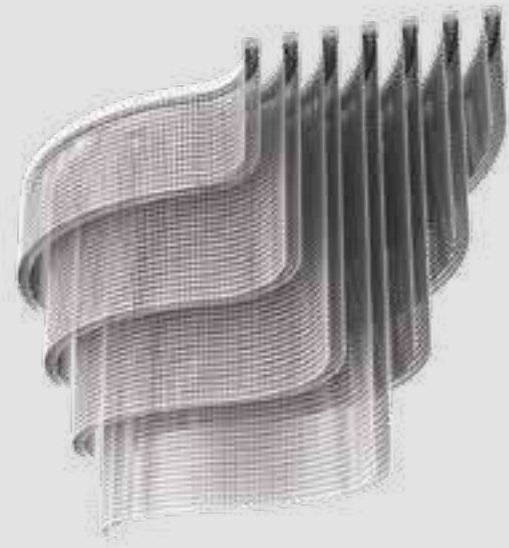
LED x 276W CRI>95 3000K -
 35535 Nominal lumen
Dimmable: 1-10V
 (1 x driver recessed)

Composition :

- A** Outside H50
12 x Arch 125
8 x Arch 50
2 x Straight 100
- B** Inside H100 (x3)
4 x Arch 50
2 x Straight 50



GALASSIA R2 SNG

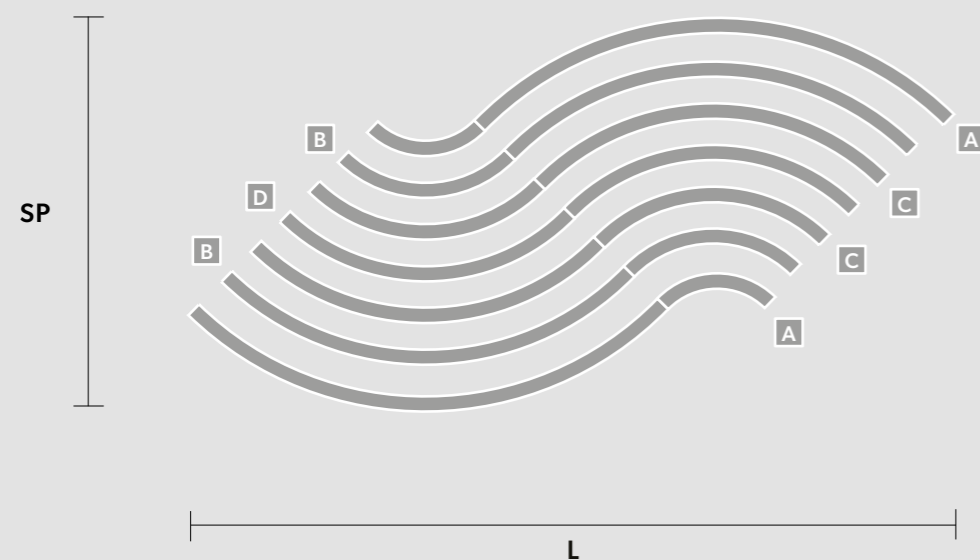


L 229 cm / 90.15"
SP 116 cm / 45.66"
H 100 cm / 39.37"
W 110 kg / 242.50 lb

LED x 150, 4W CRI>95 3000K -
 19363 Nominal lumen
Dimmable: 1-10V
 (1 x driver recessed)

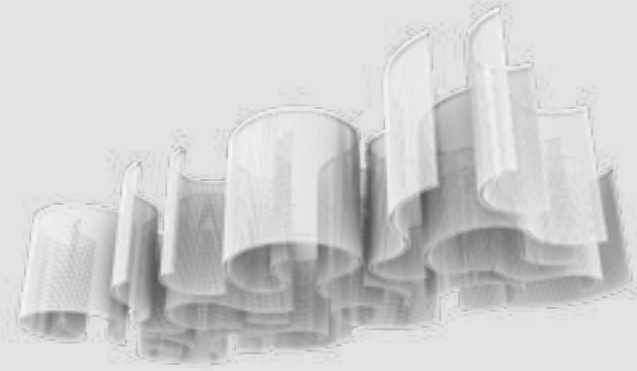
Composition :

- A** Combo A H25
2 x Arch 200
2 x Arch 50
- B** Combo B H50
2 x Arch 175
2 x Arch 75
- C** Combo C H75
2 x Arch 150
2 x Arch 100
- D** Combo D H100
2 x Arch 125



GALASSIA R2 SNG

GALASSIA T1 DBL



L 700 cm / 275.59"
SP 320 cm / 125.98"
H 50 cm / 19.68"
W 320 kg / 705.47 lb

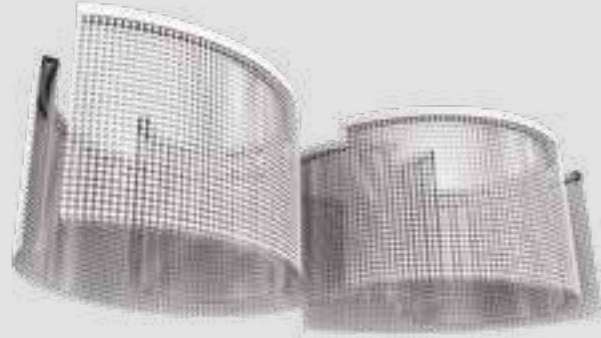
LED x 475,6W CRI>95 3000K -
61233 Nominal lumen
Dimmable: 1-10V
(2 x drivers recessed)

Composition :
18 x Arch 50
26 x Arch 75
6 x Arch 100
8 x Arch 125
6 x Arch 150
2 x Arch 175



GALASSIA T1 DBL COMPOSITION

GALASSIA T2 SNG



L 200 cm / 78.74"
SP 100 cm / 39.37"
H 50 cm / 19.68"
W 50 kg / 110.23 lb

LED x 76W CRI>95 3000K -
 9784 Nominal lumen
Dimmable: 1-10V
 (1 x driver recessed)

Composition :

5 x Arch 50
 2 x Arch 75
 1 x Arch 100
 2 x Arch 125
 1 x Arch 150



GALASSIA FINISHING

Telaio in metallo verniciato.
Pendagli in cristallo.
Illuminazione Led.

Painted metal frame.
Crystal pendants
LED lighting.

Struktur aus lackiertem Metall.
Kristallanhänger.
LED-Beleuchtung.

Structure en métal peint.
Pendentifs en cristal.
LED éclairage.

МЕТАЛЛИЧЕСКАЯ
СТРУКТУРА, В ОТДЕЛКЕ
ХРОМ, С ПОДВЕСКАМИ ИЗ
ПРОЗРАЧНОГО ИЛИ ЦВЕТНОГО
КРИСТАЛЛА.

Estructura metálica en acabado
cromado y colgantes de cristal
transparente o coloreado.

这种灯具有金属结构 (铬色),
而且水晶的吊坠们
(有色的和透明的)。

إطار معدني بلمسات نهائية من الكروم
مع دلايات كريستال شفافة أو ملونة.

Finishings



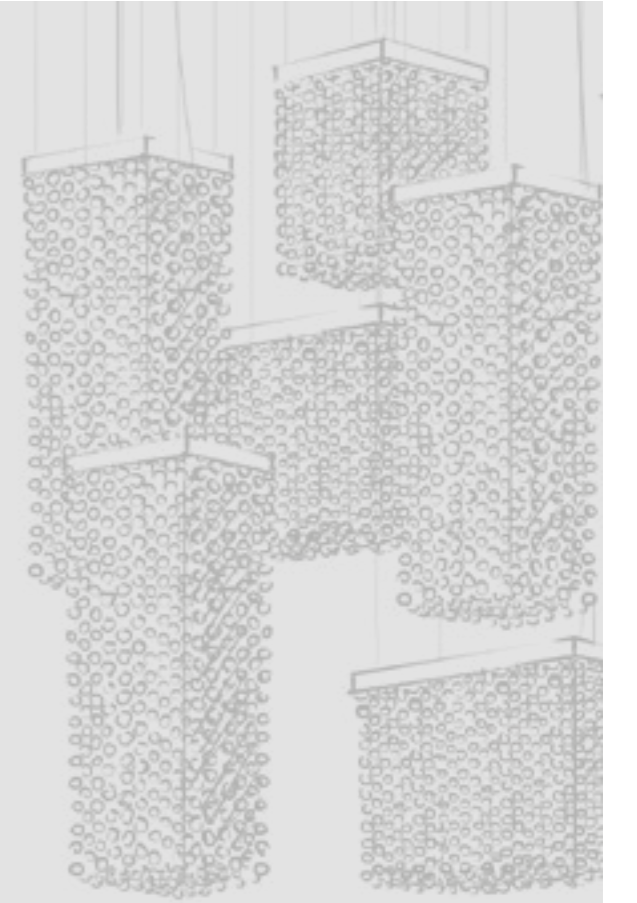
V98 Bianco goffrato
Embossed white

Pendants

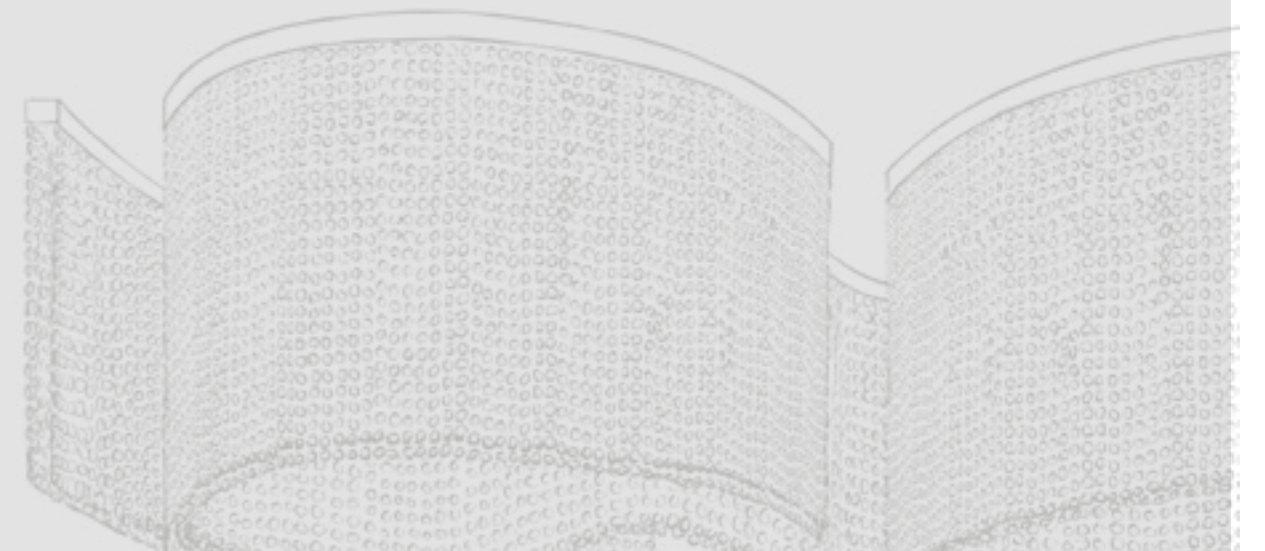
TRANSPARENT
Half cut glass /
Cut crystal /
Crystals from Swarovski®



TR Trasparente
Transparent



TECHNICAL INFO



Indice/Index

ART.	COD.	PAG.
RAQAM MODULES		
RAQAM	Module 1	6
RAQAM	Module 2	6
RAQAM	Module 3	7
RAQAM	Module 4	7
RAQAM	Module 5	6
RAQAM	Module 6	6
RAQAM	Module 7	7
RAQAM COMPOSITION		
RAQAM	M1	16
RAQAM	M6	20
RAQAM	M7	20
RAQAM	N2	24
RAQAM	N3	28
RAQAM	N4	32
RAQAM	N5	36
RAQAM	N6	36
RAQAM	N7	40
RAQAM	O1	44
RAQAM	P3	46
RAQAM	P4	50
RAQAM	Q1	54
RAQAM	Q3	54
RAQAM	Q4	54
RAQAM	Q5	58-60
RAQAM	Q6	64
RAQAM	Q7	64
RAQAM	Q8	64
RAQAM	R1	68
RAQAM	R2	74
RAQAM	R3	78
RAQAM	R4	82
CUBO CEILING MODULES		
PL/SQUARE/SMALL	20	91
PL/SQUARE/SMALL	40	91
PL/SQUARE/SMALL	60	91
PL/SQUARE/SMALL	80	91
PL/SQUARE/MEDIUM	20	91
PL/SQUARE/MEDIUM	40	91
PL/SQUARE/MEDIUM	60	91
PL/SQUARE/MEDIUM	80	91
PL/SQUARE/LARGE	20	91
PL/SQUARE/LARGE	40	91
PL/LONG	A	92
PL/LONG	B	92
PL/LONG	C	92
PL/LONG	D	92
PL/LONG	E	92
PL/LONG	F	92
PL/LONG	G	92
PL/LONG	H	92
PL/LONG	I	92
PL/LONG	J	92
PL/LONG	K	92
PL/LONG	L	92
PL/LONG	M	93
PL/LONG	N	93
PL/LONG	O	93
PL/LONG	P	93
PL/LONG	Q	93
PL/LONG	R	93
PL/LONG	S	93
PL/LONG	T	93
CUBO COMBO CEILING		
CUBO COMBO	PL 100 SQ	94
CUBO COMBO	PL 150 RC	95
CUBO COMBO	PL 175 SQ	96
CUBO COMBO	PL 300 RC	101

ART.	COD.	PAG.	
CUBO COMBO	PL 8 200 SQ	100	
CUBO COMBO	PL 16 200 RC	102	
CUBO COMBO	PL 21 200 SQ	98	
CUBO SUSPENSION MODULES			
S/SQUARE/SMALL	20	107	
S/SQUARE/SMALL	40	107	
S/SQUARE/SMALL	60	107	
S/SQUARE/SMALL	80	107	
S/SQUARE/MEDIUM	20	107	
S/SQUARE/MEDIUM	40	107	
S/SQUARE/MEDIUM	60	107	
S/SQUARE/MEDIUM	80	107	
S/SQUARE/LARGE	20	107	
S/SQUARE/LARGE	40	107	
S/LONG	A	108	
S/LONG	B	108	
S/LONG	C	108	
S/LONG	D	108	
S/LONG	E	108	
S/LONG	F	108	
S/LONG	G	108	
S/LONG	H	108	
S/LONG	I	108	
S/LONG	J	108	
S/LONG	K	108	
S/LONG	L	108	
S/LONG	M	109	
S/LONG	N	109	
S/LONG	O	109	
S/LONG	P	109	
S/LONG	Q	109	
S/LONG	R	109	
S/LONG	S	109	
S/LONG	T	109	
CUBO COMBO SUSPENSION			
CUBO COMBO	S 100 SQ	110	
CUBO COMBO	S 150 RC	111	
CUBO COMBO	S 175 SQ	112	
CUBO COMBO	S 300 RC	120	
CUBO COMBO	S 12 200 SQ	116	
CUBO COMBO	S 24 200 RC	121	
CUBO COMBO	S 40 200 RC	117	
CUBO COMBO	S 64 100 SQ	114	
GALASSIA MODULES			
CURVED MODULE	ARCH 50	128	
CURVED MODULE	ARCH 75	128	
CURVED MODULE	ARCH 100	128	
CURVED MODULE	ARCH 125	128	
CURVED MODULE	ARCH 150	128	
CURVED MODULE	ARCH 175	128	
CURVED MODULE	ARCH 200	128	
CORNER MODULE	CORNER 20x20	129	
STRAIGHT MODULE	STRAIGHT 100	129	
STRAIGHT MODULE	STRAIGHT 50	129	
GALASSIA			
GALASSIA	M1	SNG	132
GALASSIA	M1	TPL	130
GALASSIA	N1	DBL	133
GALASSIA	N2	DBL	134
GALASSIA	O1	SNG	136
GALASSIA	O1	TPL	138
GALASSIA	O2	DBL	141
GALASSIA	O3	SNG	142
GALASSIA	P1	SNG	144
GALASSIA	P1	DBL	145
GALASSIA	Q1	SNG	148
GALASSIA	Q1	TPL	149
GALASSIA	R1	DBL	146
GALASSIA	R2	SNG	150
GALASSIA	T1	SNG	140
GALASSIA	T1	DBL	152
GALASSIA	T2	SNG	154

CE

Attesta la conformità del prodotto alle disposizioni delle Direttive comunitarie.

It certifies the conformity of the products to the European Community provisions.

Il atteste la conformité du produit aux dispositions des directives communitaires.

Konformität des Produktes mit den Richtlinien der europäischen Gemeinschaft.

НАСТОЯЩИМ ПОДТВЕРЖДАЕТСЯ СООТВЕТСТВИЕ ПРОДУКЦИИ ПОЛОЖЕНИЯМ ДИРЕКТИВ ЕС.

Certifica la conformidad del producto según las disposiciones de las directivas comunitarias.

CE标记是指产品的制造商证明该产品符合适用的EC指令的所有基本要求。

يُشهد بمطابقة المنتج لأحكام توجيهات المجتمع الأوروبي.



Il logo "ETL" si riferisce agli articoli che possono essere modificati con componenti certificati ETL. L'elenco degli articoli ETL si riferisce a prodotti testati e valutati in base agli standard di sicurezza del mercato statunitense. Per il mercato USA fare riferimento al listino dedicato.

"ETL" logos refers to articles which can be modified with ETL-compliance components. The "ETL" listing articles stands for tested and evaluated product to recognised US safety standards. For the US market, refer to the relevant price list.

"ETL" logo se réfère aux articles qui peuvent être modifiées par des composants certifiés ETL. la liste des articles ETL se réfère à des produits testés et évalués selon les normes de sécurité du marché américain. Pour le marché américain se référer à la liste des prix.

Das "ETL"-Logo bezieht sich auf Artikel, die mit ETL-zertifizierten Komponenten modifiziert werden können. Die Liste der ETL-Artikel bezieht sich auf Produkte, die nach den Sicherheitsstandards des US-Marktes getestet und bewertet wurden. Für den US-Markt beachten Sie bitte die entsprechende Preisliste.

ЛОГОТИП «ETL» ОТНОСИТСЯ К ЭЛЕМЕНТАМ, КОТОРЫЕ МОГУТ БЫТЬ МОДИФИЦИРОВАНЫ С ПОМОЩЬЮ СЕРТИФИЦИРОВАННЫХ ETL КОМПОНЕНТОВ. СПИСОК ЭЛЕМЕНТОВ ETL ОТНОСИТСЯ К ПРОДУКЦИИ, ПРОТЕСТИРОВАННОЙ И ОЦЕНЕННОЙ В СООТВЕТСТВИИ С ПРИЗНАННЫМИ СТАНДАРТАМИ БЕЗОПАСНОСТИ США. ДЛЯ ПОТРЕБИТЕЛЕЙ НАХОДЯЩИХСЯ В США СМ. СООТВЕТСТВУЮЩИЙ ПРАЙС-ЛИСТ.

El logo "ETL" indica los artículos, que pueden modificarse con componentes certificados ETL. La lista de los artículos ETL se refiere a los productos sometidos a prueba y evaluados en función de los estándares de seguridad del mercado estadounidense. Consultar la lista de precios específica para el mercado de los Estados Unidos.

"ETL" 徽标是指可以使用ETL认证的组件进行修改的项目。 ETL项目列表是指根据美国市场的安全标准进行测试和评估的产品。 对于美国市场, 请参考美国市场价格表。

يشير شعار «ETL» إلى المنتجات التي يمكن تعديلها باستخدام مكونات مُعتمدة من ETL. تشير قائمة منتجات ETL إلى المنتجات التي تم اختبارها وتقييمها وفقاً لمعايير السلامة في السوق الأمريكي. بالنسبة لسوق الولايات المتحدة الأمريكية، يُرجى الرجوع إلى قائمة الأسعار المُخصصة.

Im

Flusso luminoso nominale. L'indicazione si riferisce al valore in assenza di rifrazione, come dichiarato dal produttore del componente.

Nominal luminous flux. It refers to the value without any refraction, as declared by the component manufacturer.

L'unité SI de flux lumineux. L'indication correspond à la valeur en l'absence de réfraction, comme indiqué par le fabricant du composant.

Die Maßeinheit für den Lichtstrom. Die Angabe bezieht sich auf den Wert in der Abwesenheit von Brechung, wie vom Hersteller der Komponente angegeben.

НОМИНАЛЬНЫЙ СВЕТОВОЙ ПОТОК. УКАЗАНИЕ ОТНОСИТСЯ К ЗНАЧЕНИЮ В ОТСУТСТВИЕ РЕФРАКЦИИ, КАК ЗАЯВЛЕНО ПРОИЗВИТЕЛЕМ КОМПОНЕНТОВ.

Flujo luminoso nominal. La indicación se refiere al valor sin refracción, como declarado por el fabricante del componente.

标称光通量。指示是指组件制造商声明的没有折射的值。

التدفق الضوئي الاسمي. يشير المؤشر إلى القيمة في حالة عدم وجود انكسار للضوء، كما هو مُعلن من قبل الشركة المصنعة للعنصر.

MASIERO

Masiero si riserva il diritto di apportare ai propri articoli, senza nessun preavviso, qualsiasi modifica ritenesse opportuna.

Masiero reserves the right to introduce any changes to its own products, without notice in advance.

Masiero se réserve le droit d'apporter une quelconque modification à les modèles sans préavis.

Masiero behalt sich das Recht vor änderungen vorzunehmen, ohne sofortige Benachrichtigung.

КОМПАНИЯ MASIERO ОСТАВЛЯЕТ ЗА СОБОЙ ПРАВО БЕЗ ПРЕДВАРИТЕЛЬНОГО УВЕДОМЛЕНИЯ, ЕСЛИ ЭТО БУДЕТ СОЧТЕНО ЦЕЛЕСООБРАЗНЫМ, ВНОСИТЬ В СОБСТВЕННЫЕ МОДЕЛИ ЛЮБЫЕ ИЗМЕНЕНИЯ.

Masiero se reserva el derecho de aportar modificaciones consideradas oportunas a sus artículos sin preaviso.

Masiero 保留对其认为适当的任何更改的权利, 恕不另行通知。

تحتفظ شركة مازيرو "Masiero" بالحق في إجراء أي تعديلات تراها مناسبة على منتجاتها، دون إشعار مسبق.

Masiero srl

via Peschiere, 53
31032 Casale sul Sile
Treviso, Italy
T +39 0422 7861
F +39 0422 786250

info@masierogroup.com
masierogroup.com

Design by Masiero
Photo, Studio Pointer
Print Italy, April 2021
by Grafica Antiga



CHANDELIERS
ATELIER

MASIERO



CHANDELIERS
ATELIER

MASIERO



CHANDELIERS

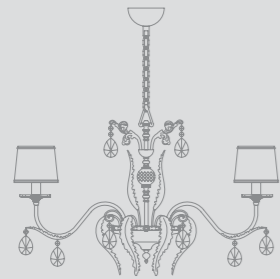
C'è un posto dove classico e moderno si incontrano, contaminandosi, fondendosi per bilanciare innovazione e tradizione.

La bellezza prende forma creando collezioni di lampade senza tempo, dedicate a chi guarda con piacere il mondo contemporaneo, senza dimenticarsi delle origini classiche.

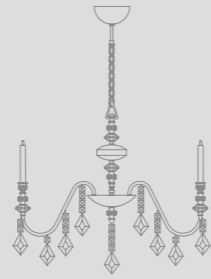
There is a place where classic and modern meet in mutual contamination and merge to balance innovation and tradition.

Beauty takes shape to create timeless collections of lighting elements, dedicated to all those who like to look at the contemporary world without forgetting their classical origins.

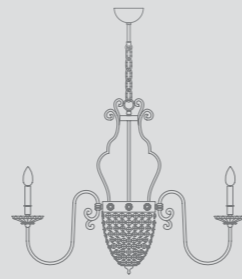
Indice/Index



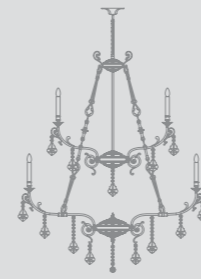
Acantia
26



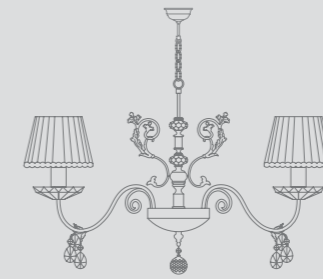
Chic
16



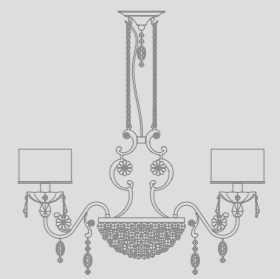
Elegantia
40



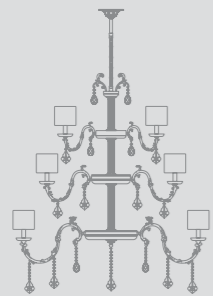
Odessa
110



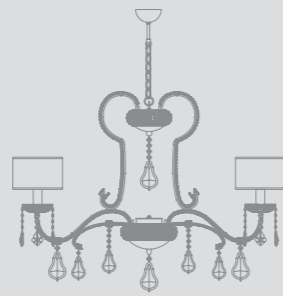
Primadonna
72



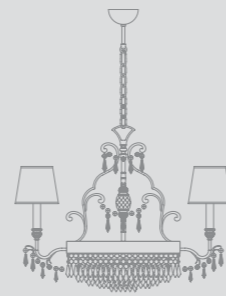
Rosemary
88



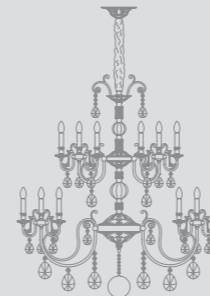
Eternity
62



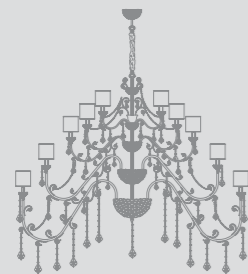
Galá
100



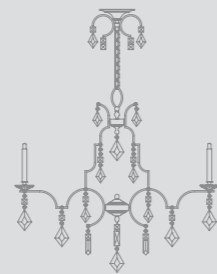
Glassé
122



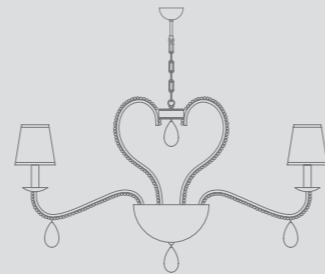
Zaira
82



Imperial
132



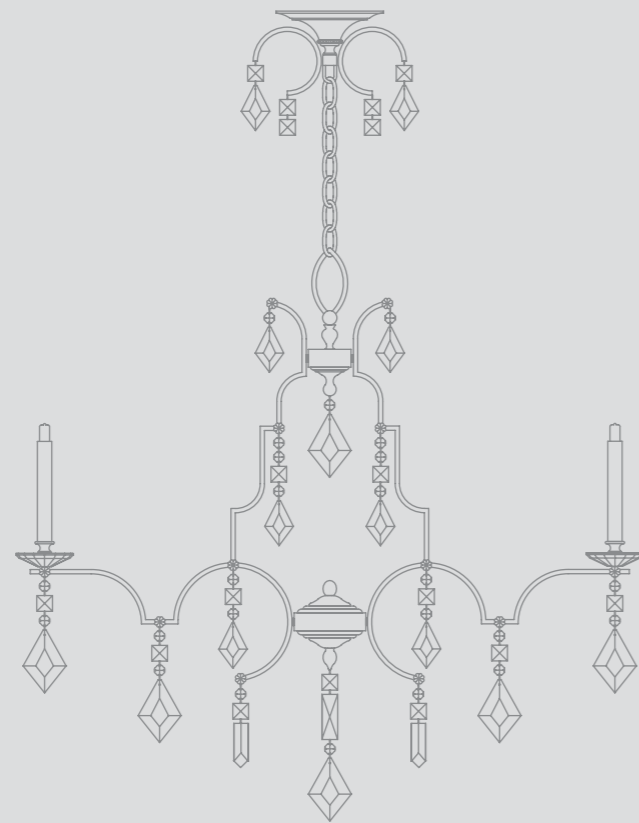
Lizzi
6



Noblesse
54

LIZZI

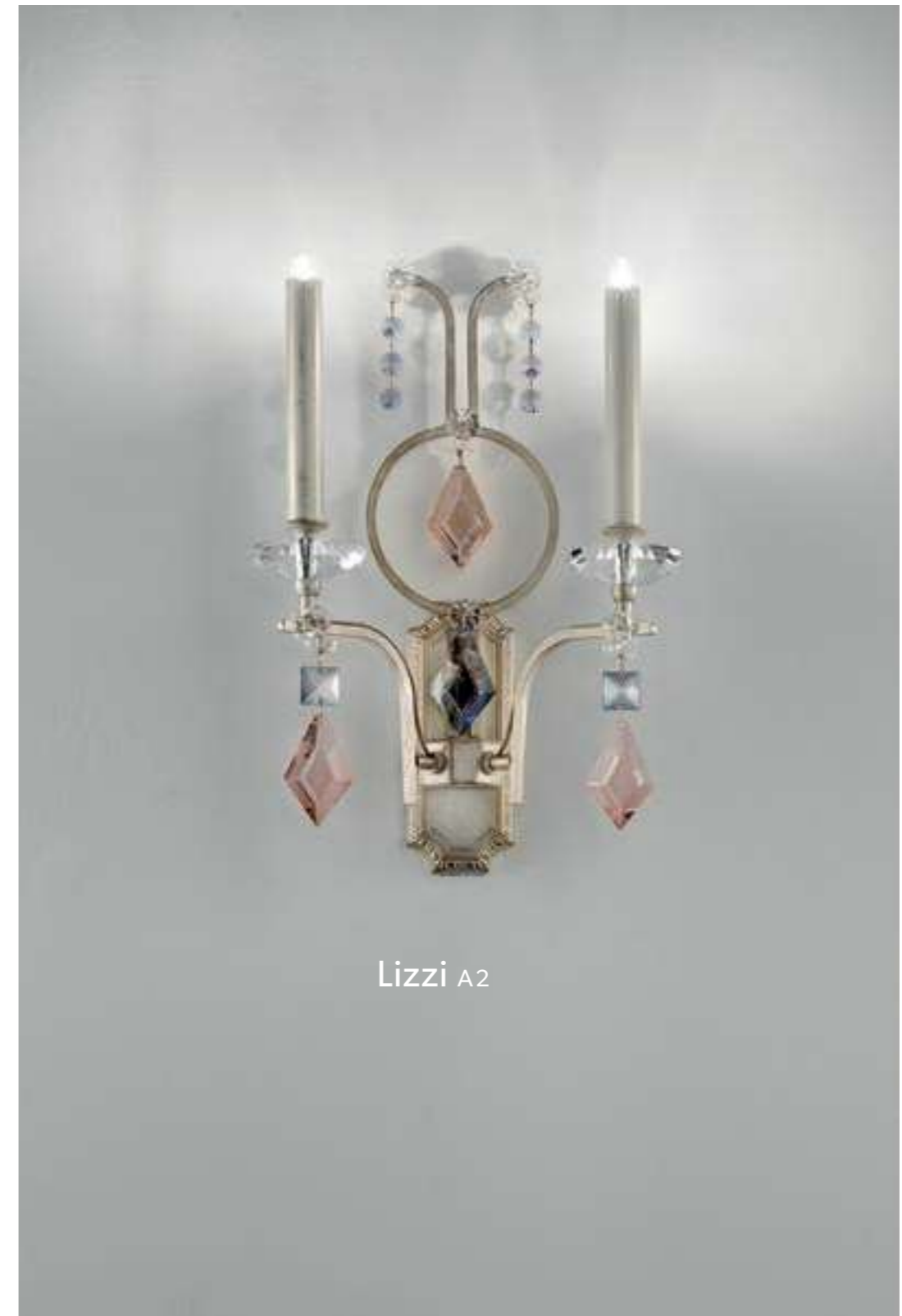
design by Masiero Lab



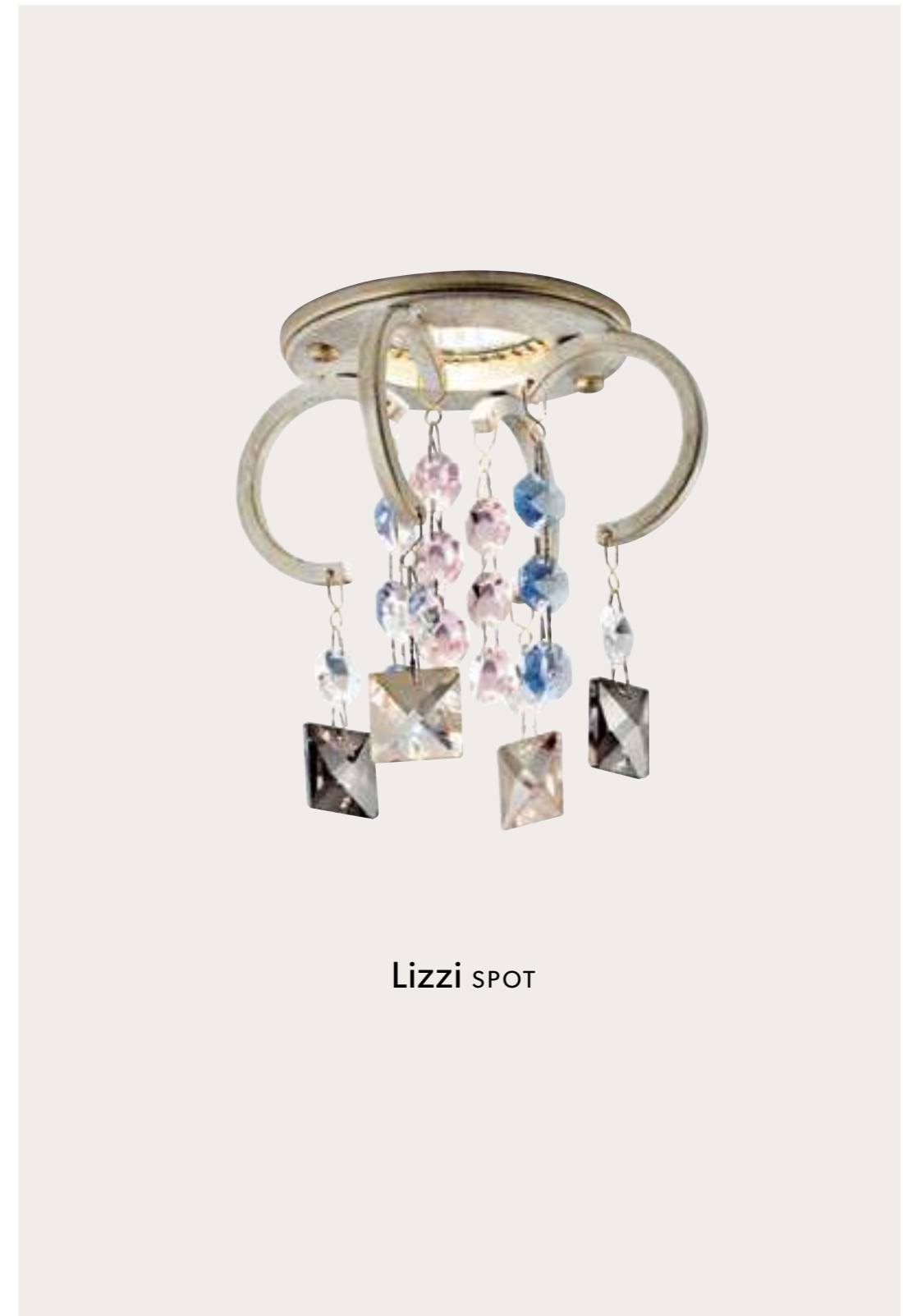
Lizzi 6+6

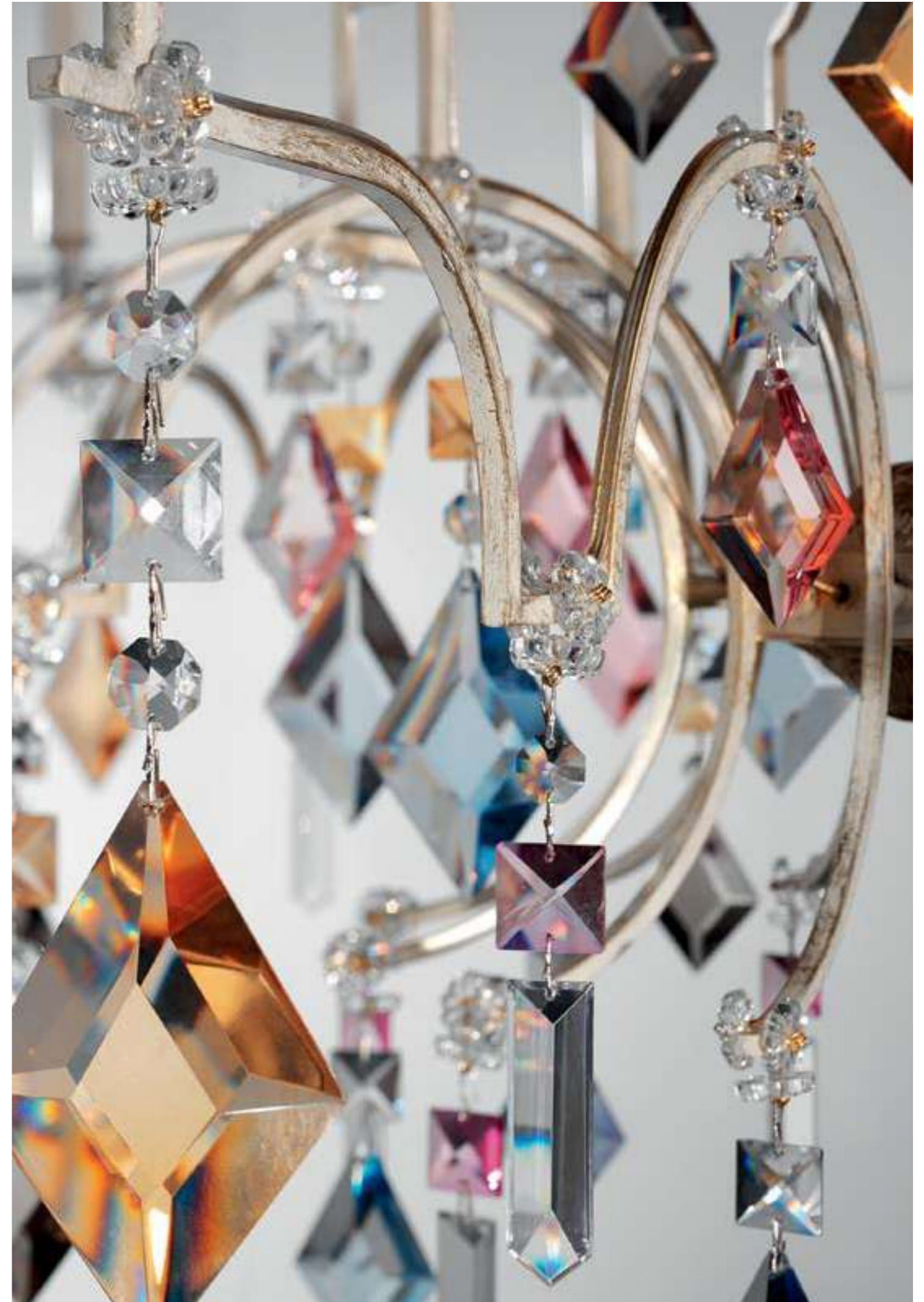


Lizzi s1



Lizzi A2





LIZZI

Struttura in metallo con pendagli in cristallo colorato.

Metal frame with coloured crystal pendants.

Metallstruktur mit Behang aus farbigem Kristall.

Structure en métal avec pampilles en cristal coloré.

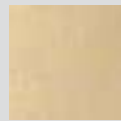
Estructura de metal con piezas colgantes en cristal de color.

МЕТАЛЛИЧЕСКИЙ КАРКАС С ПОДВЕСАМИ ИЗ ЦВЕТНОГО ХРУСТАЛЯ

这个灯具的结构是金属。而且这种系列也有彩色水晶的吊坠。

هيكل معدني مع دلايات من الكريستال الملون.

Standard finishings



V13
Beige e Oro
Ivory and Gold

Family



Chandelier



Suspension



Spot

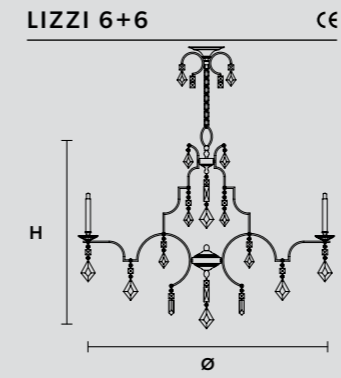
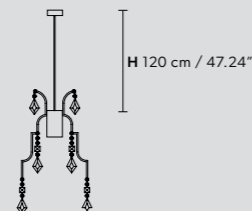
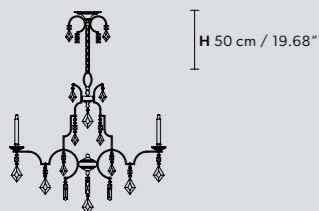


Applique



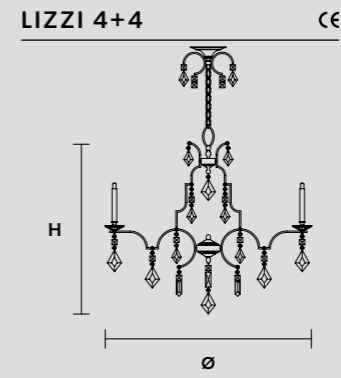
Ceiling

Standard chain/cable for all chandelier/suspension



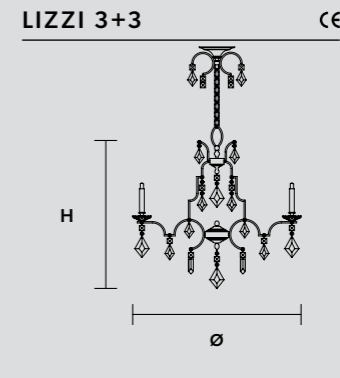
LIZZI 6+6 CE
Ø 105 cm / 41.34"
H 85 cm / 33.46"

WW 12×G9×40 W max (not included)
USA 12×G9×40 W max (not included)



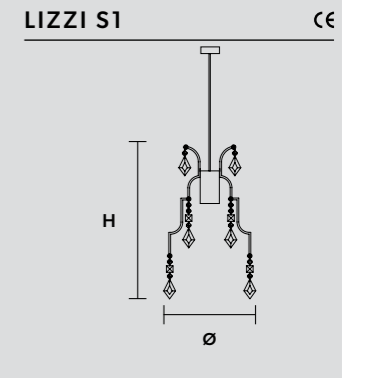
LIZZI 4+4 CE
Ø 90 cm / 35.43"
H 75 cm / 29.53"

WW 8×G9×40 W max (not included)
USA 8×G9×40 W max (not included)



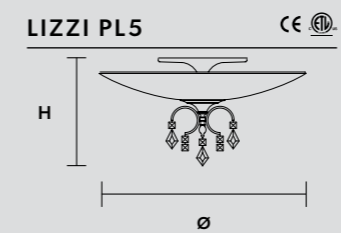
LIZZI 3+3 CE
Ø 75 cm / 29.53"
H 65 cm / 25.59"

WW 6×G9×40 W max (not included)
USA 6×G9×40 W max (not included)



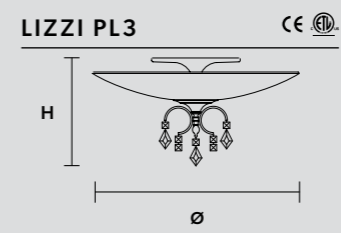
LIZZI S1 CE
Ø 36 cm / 14.17"
H 53 cm / 20.86"

WW 1×GU10×50W max (not included)
USA 1×GU10×50W max (not included)



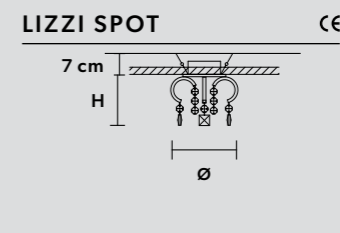
LIZZI PL5 CE
Ø 70 cm / 27.56"
H 40 cm / 15.75"

WW 5×E27×60 W max (not included)
USA 5×E26×60 W max (not included)



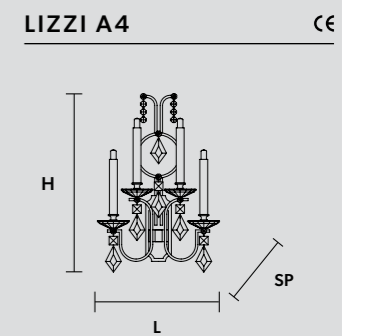
LIZZI PL3 CE
Ø 55 cm / 21.65"
H 40 cm / 15.75"

WW 3×E27×60 W max (not included)
USA 3×E26×60 W max (not included)



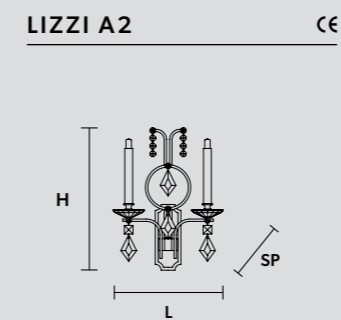
LIZZI SPOT CE
Ø 13 cm / 5.12"
H 12 cm / 4.72"

WW 1×GU10×50W max (not included)
USA 1×GU10×50W max (not included)



LIZZI A4 CE
L 32 cm / 12.60"
SP 20 cm / 7.87"
H 42 cm / 16.54"

WW 4×G9×40 W max (not included)
USA 4×G9×40 W max (not included)



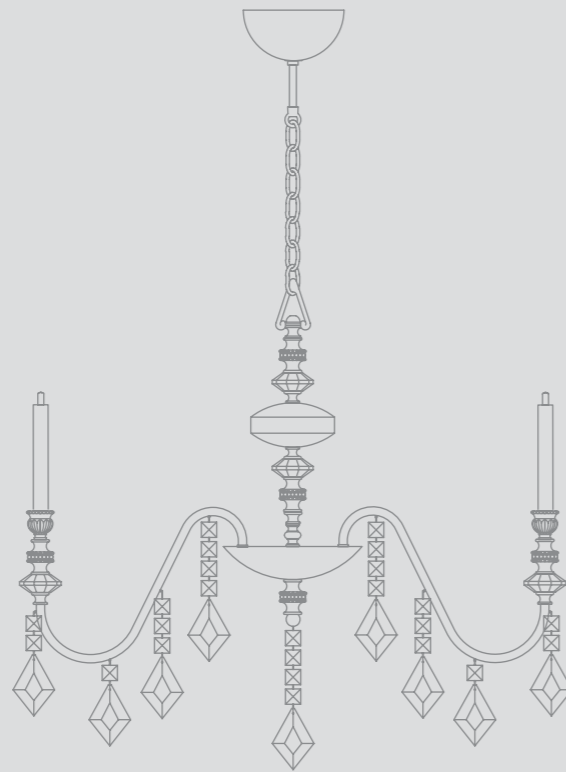
LIZZI A2 CE
L 25 cm / 9.84"
SP 13 cm / 5.51"
H 38 cm / 15"

WW 2×G9×40 W max (not included)
USA 2×G9×40 W max (not included)

Ⓢ : For the US market, refer to the relevant price list.

CHIC

design by Masiero Lab



Chic 12





Chic 3



Chic STL3



Chic A2 N



Chic TL1 P

Chic TL1 G



CHIC

Struttura in metallo con inserti in fusione d'ottone e cristallo colorato. Pendagli in cristallo colorato.

Metal frame with cast brass and coloured crystal inserts. Coloured crystal pendants.

Metallstruktur mit Einsätzen aus Messingguss und farbigem Kristall. Behang aus farbigem Kristall.

Structure en métal avec inserts en laiton moulé et cristal coloré. Pampilles en cristal coloré.

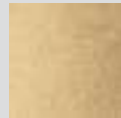
Estructura de metal con insertos realizados en fundición de latón y cristal de color. Piezas colgantes en cristal de color.

МЕТАЛЛИЧЕСКИЙ КАРКАС С ЛИТЫМИ ЛАТУННЫМИ ВСТАВКАМИ И ЦВЕТНЫМ ХРУСТАЛЕМ. ПОДВЕСЫ ИЗ ЦВЕТНОГО ХРУСТАЛЯ.

这个灯具的结构是金属, 而且有黄铜铸件与彩色水晶的装饰。这个系列也有水晶吊坠和合成材料的灯罩。

هيكل معدني مع مدخلات من صب النحاس الأصفر والكريستال الملون. دلايات من الكريستال الملون.

Standard finishings



F01
Foglia d'oro
Gold leaf



F02
Foglia d'argento
Silver leaf

Family



Chandelier



Applique

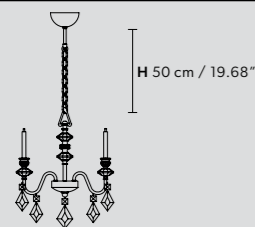


Table lamp



Floor lamp

Standard chain for all chandeliers



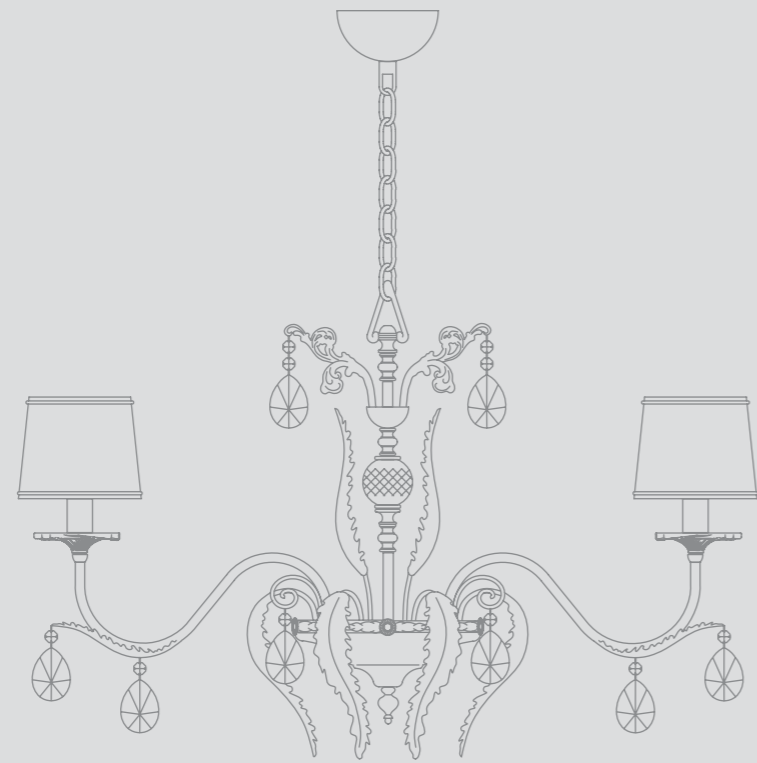
CHIC 12	CHIC 8	CHIC 5	CHIC 3
∅ 115 cm / 45.28" H 82 cm / 32.28"	∅ 80 cm / 31.49" H 70 cm / 27.55"	∅ 50 cm / 19.69" H 60 cm / 23.62"	∅ 43 cm / 16.93" H 45 cm / 17.72"
WW 12×G9×40 W max (not included) USA 12×G9×40 W max (not included)	WW 8×G9×40 W max (not included) USA 8×G9×40 W max (not included)	WW 5×G9×40 W max (not included) USA 5×G9×40 W max (not included)	WW 3×G9×40 W max (not included) USA 3×G9×40 W max (not included)

CHIC A2 N	CHIC TL1 G	CHIC TL1 P	CHIC STL 3
L 37 cm / 14.57" SP 12 cm / 4.72" H 60 cm / 23.62"	∅ 16 cm / 6.30" H 55 cm / 21.65"	∅ 12 cm / 4.72" H 30 cm / 11.81"	∅ 40 cm / 15.75" H 170 cm / 66.93"
WW 2×G9×40 W max (not included) USA 2×G9×40 W max (not included)	WW 1×G9×40 W max (not included) USA 1×G9×40 W max (not included)	WW 1×G9×40 W max (not included) USA 1×G9×40 W max (not included)	WW 3×G9×40 W max (not included) USA 3×G9×40 W max (not included)

Ⓜ : For the US market, refer to the relevant price list.

ACANTIA

design by Masiero Lab



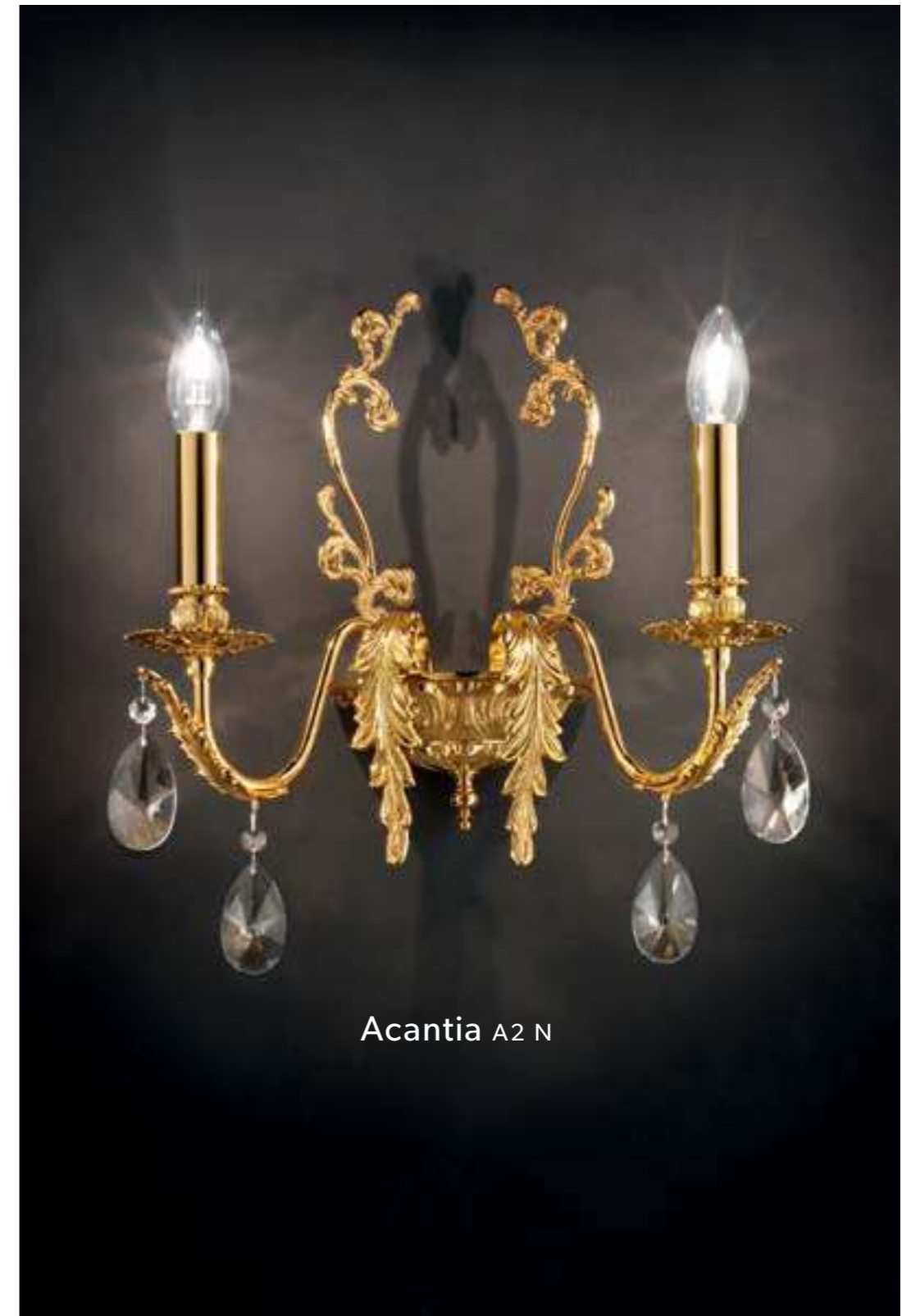
Acantia 12



Acantia 8



Acantia A2

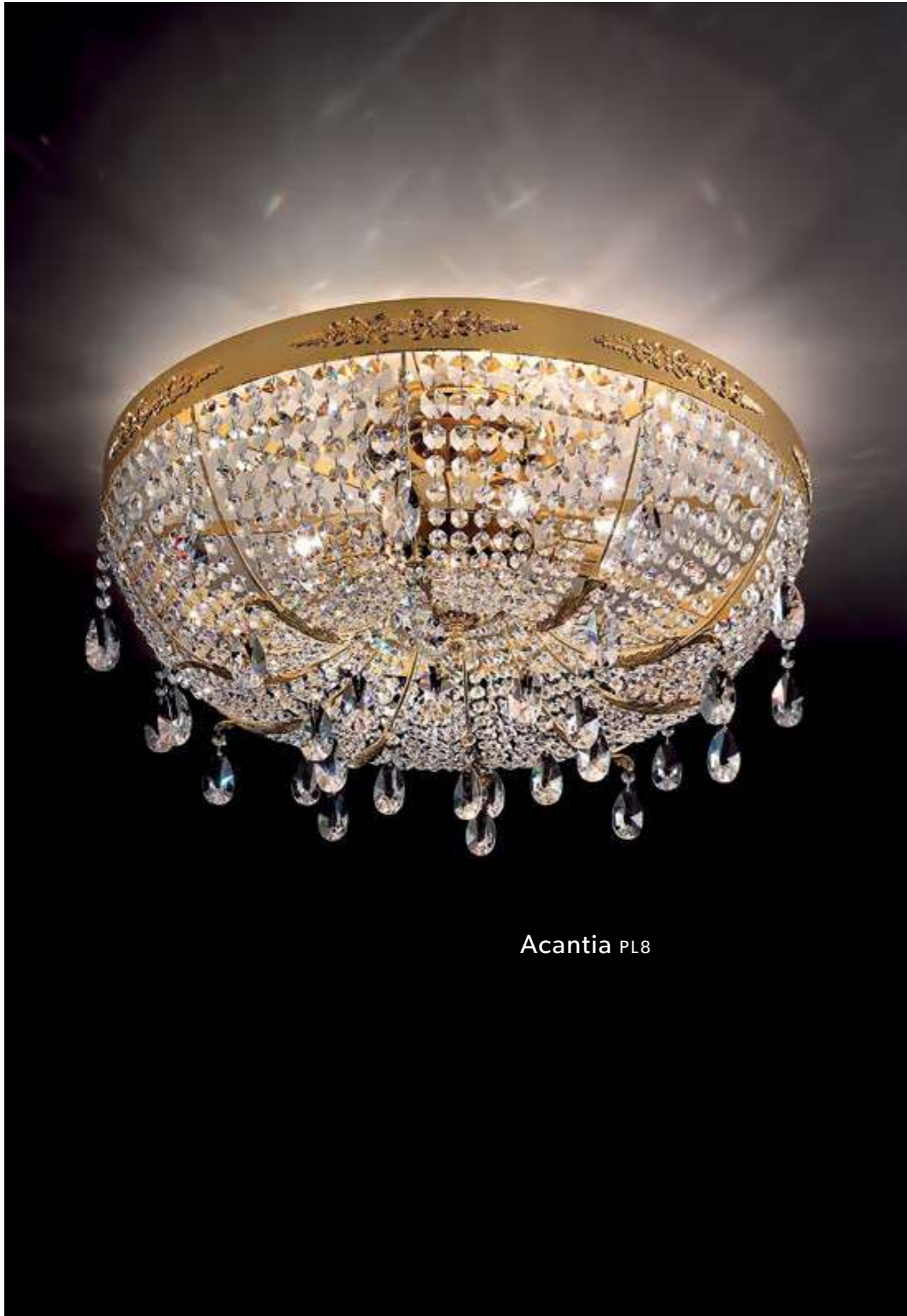




Acantia TL1 N



Acantia PL40





ACANTIA

Telaio in metallo e fusione d'ottone.
Paralumi in tessuto damascato.

Cast brass and metal frame.
Damask fabric lampshades.

Metallstruktur mit Messingguss
Lampenschirme aus Damast.

Structure en métal et laiton moulé
Abat-jours damassés.

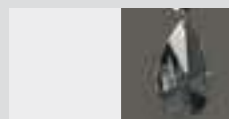
Estructura de metal y fundición de latón.
Pantallas en tejido adamsado.

МЕТАЛЛИЧЕСКИЙ КАРКАС И ЛАТУННОЕ ЛИТЬЕ АБАЖУРЫ ИЗ ТКАНИ С КАМЧАТНЫМ УЗОРОМ.

这个灯具的结构是金属跟黄铜铸件。而且这种灯具也有锦缎面料的灯罩。

إطار معدني وصب نحاس أصفر. عاكس ضوء (أباجورة) من قماش دمقس.

Finishings Cut Crystal



V95 Matt white + transparent pendants

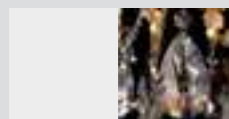


G03+F01 Shiny gold + Gold leaf + transparent pendants

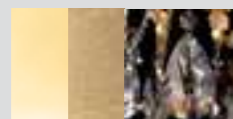


V90 Matt black + black pendants

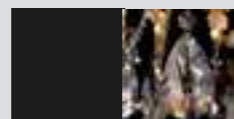
Finishings Swarovski / Half cut glass*



V95 Matt white + transparent pendants



G03+F01 Shiny gold + Gold leaf + transparent pendants



V90 Matt black + transparent pendants

*Only available for ACANTIA PL4/ ACANTIA PL6/ACANTIA PL8

Family



Chandelier



Applique

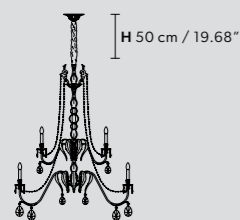


Ceiling

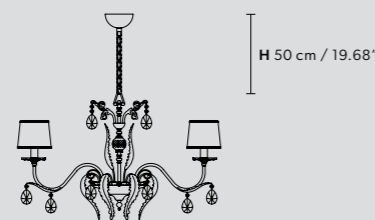


Table lamp

Standard chain for all chandeliers

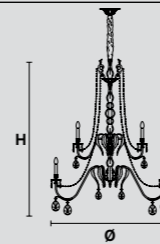


H 50 cm / 19.68"



H 50 cm / 19.68"

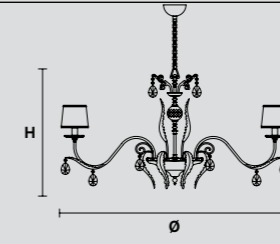
ACANTIA 15



Ø 120 cm / 47.24"
H 150 cm / 59.06"

WW 15xE14x40 W max (not included)
USA 15xE12x40 W max (not included)

ACANTIA 12

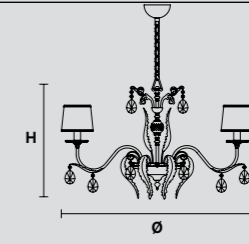


Ø 120 cm / 47.24"
H 60 cm / 27.55"

WW 12xE14x40 W max (not included)
USA 12xE12x40 W max (not included)

Paralumi / Shade DAM/14/WH
Paralumi / Shade DAM/14/BK

ACANTIA 8

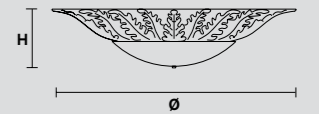


Ø 85 cm / 33.46"
H 50 cm / 19.68"

WW 8xE14x40 W max (not included)
USA 8xE12x40 W max (not included)

Paralumi / Shade DAM/14/WH
Paralumi / Shade DAM/14/BK

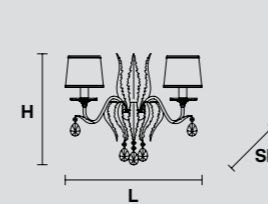
ACANTIA PL40



Ø 40 cm / 15.74"
H 9 cm / 3.54"

WW 3xG9x40 W max (not included)
USA 3xG9x40 W max (not included)

ACANTIA A2

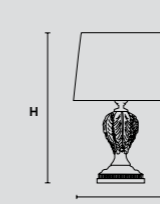


L 45 cm / 17.71"
SP 18 cm / 7.08"
H 40 cm / 15.74"

WW 2xE14x40 W max (not included)
USA 2xE12x40 W max (not included)

Paralumi / Shade DAM/14/WH
Paralumi / Shade DAM/14/BKw

ACANTIA TL1N

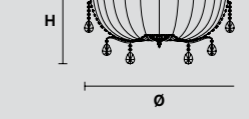


Ø 30 cm / 11.81"
H 46 cm / 18.11"

WW 1xE27x60 W max (not included)
USA 1xE26x60 W max (not included)

Paralumi / Shade DAM/30/WH
Paralumi / Shade DAM/30/BK

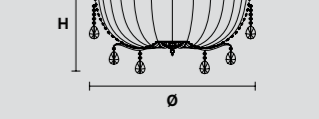
ACANTIA PL4



Ø 50 cm / 19.68"
H 35 cm / 13.78"

WW 4xE27x60 W max (not included)
USA 4xE26x60 W max (not included)

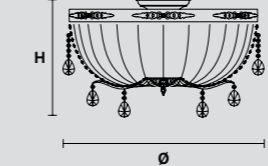
ACANTIA PL6



Ø 70 cm / 27.56"
H 40 cm / 15.75"

WW 6xE27x60 W max (not included)
USA 6xE26x60 W max (not included)

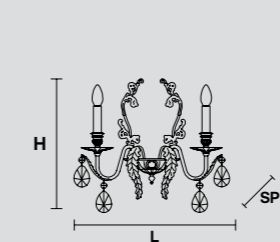
ACANTIA PL8



Ø 90 cm / 35.43"
H 50 cm / 19.68"

WW 8xE27x60 W max (not included)
USA 8xE26x60 W max (not included)

ACANTIA A2N



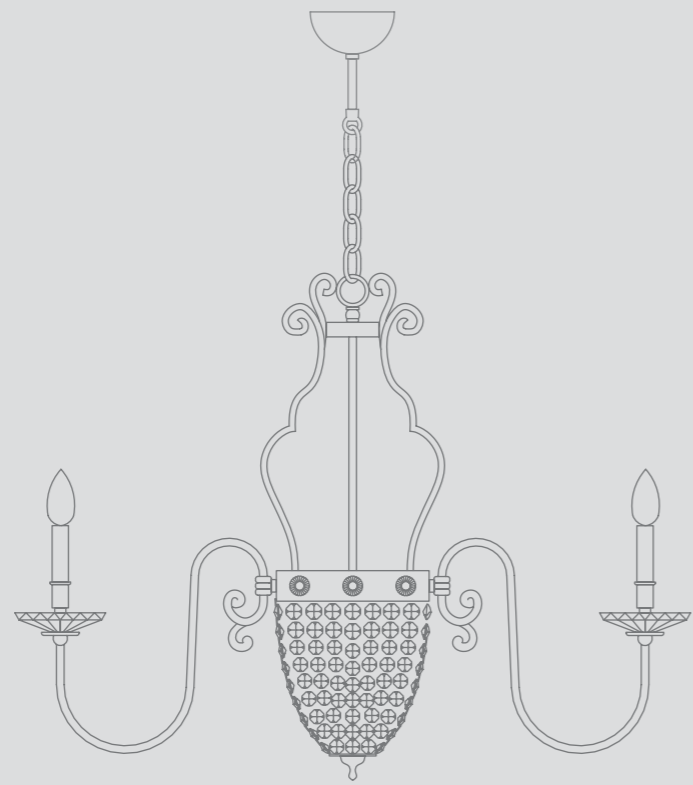
L 40 cm / 15.75"
SP 20 cm / 7.87"
H 40 cm / 15.75"

WW 2xE14x40 W max (not included)
USA 2xE12x40 W max (not included)

Ⓜ : For the US market, refer to the relevant price list.

ELEGANTIA

design by Masiero Lab



Elegancia 8+1



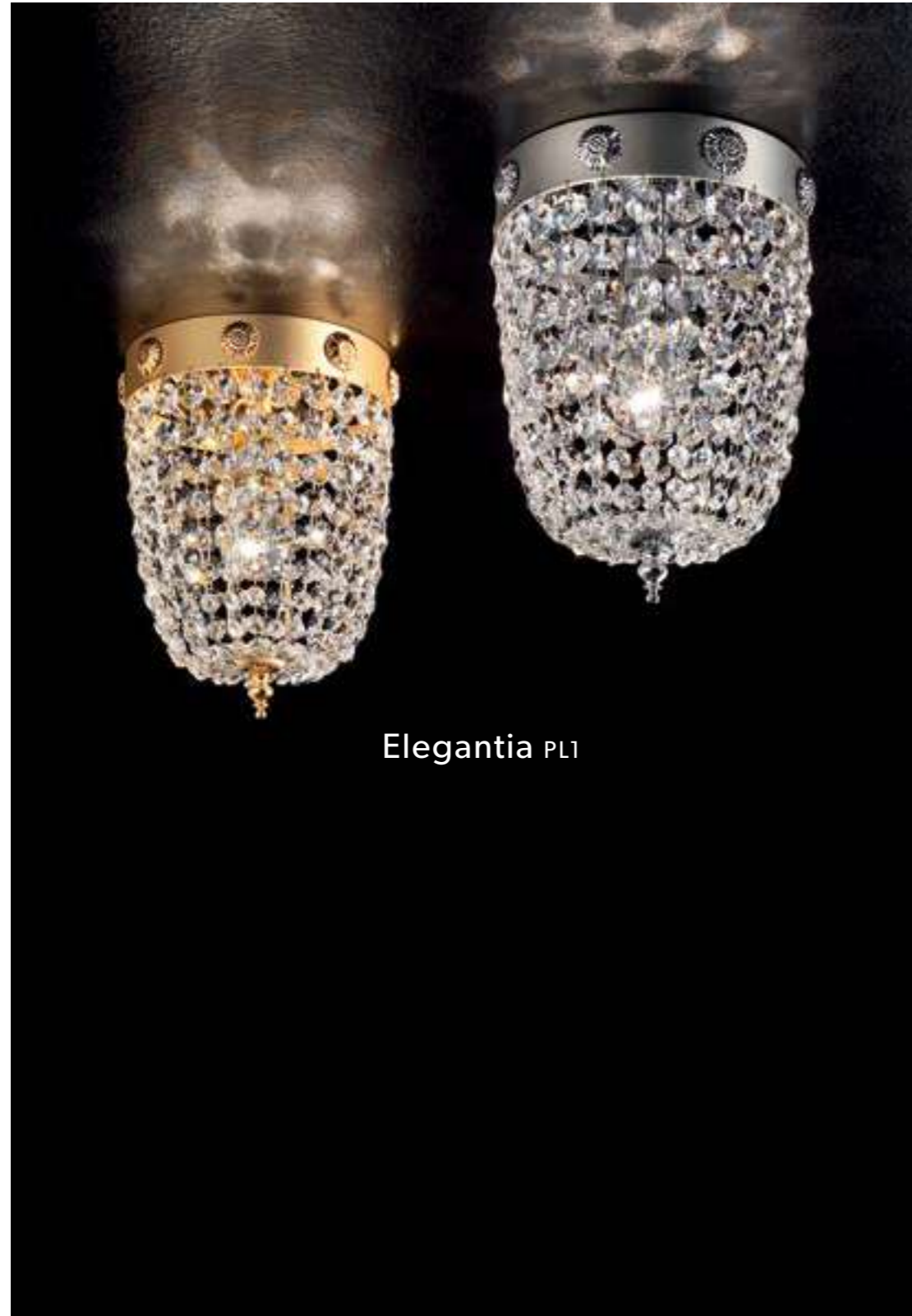


Elegancia TLI P



Elegancia TLI G

Elegancia STL3



Elegantia PL1



Elegantia 8+1



Elegantia 3+1



Elegantia PL4



ELEGANTIA

Struttura di metallo in finitura galvanica con pendagli trasparenti.

Galvanic Bath Metal Frame with trasparent crystal pendants.

Metallstruktur in galvanischer Ausführung. Transparente Kristall-Anhänger.

Structure en métal, finition galvanique avec pampille transparent.

Estructura de metal con acabado galvanizado y piezas colgantes transparentes.

МЕТАЛЛИЧЕСКИЙ КАРКАС С ГАЛЬВАНИЧЕСКОЙ ОТДЕЛКОЙ С ПРОЗРАЧНЫМИ ХРУСТАЛЬНЫМИ ПОДВЕСАМИ.

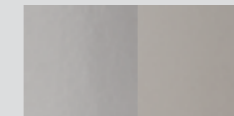
这个灯具的结构是金属跟电镀表面。而且这种系列也有透明的水晶吊坠。

هيكل معدني بتشطيب جلفاني مع دلايات شفافة.

Standard finishings



G03+G05
Oro lucido+Oro opaco
Shiny gold+ Matt gold



G04+G06
Cromo lucido+Cromo opaco
Shiny chrome+Matt chrome

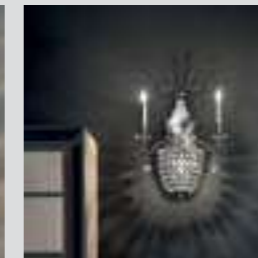
Family



Chandelier



Suspension



Applique



Ceiling

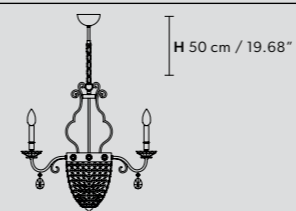



Table lamp

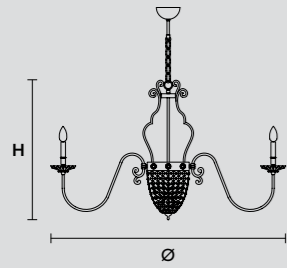


Floor lamp

Standard chain for all chandeliers




ELEGANTIA 12+1 

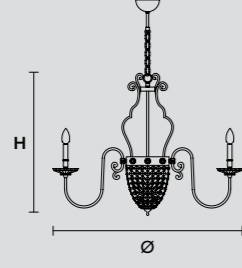


Ø 110 cm / 43.40"
H 65 cm / 25.60"

WW 12×E14×40 W max (not included)
1×E27×60 W max (not included)
USA 12×E12×40 W max (not included)
1×E26×60 W max (not included)

NO LAMPSHADES INCLUDED


ELEGANTIA 8+1 

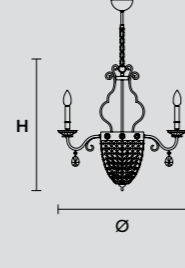


Ø 85 cm / 33.46"
H 65 cm / 25.60"

WW 8×E14×40 W max (not included)
1×E27×60 W max (not included)
USA 8×E12×40 W max (not included)
1×E26×60 W max (not included)

NO LAMPSHADES INCLUDED

ELEGANTIA 3+1 

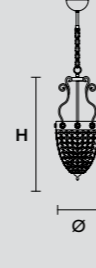


Ø 45 cm / 17.72"
H 60 cm / 23.62"

WW 3×E14×40 W max (not included)
1×E27×60 W max (not included)
USA 3×E12×40 W max (not included)
1×E26×60 W max (not included)

NO LAMPSHADES INCLUDED

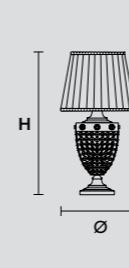
ELEGANTIA 1 



Ø 20 cm / 7.87"
H 55 cm / 21.65"

WW 1×E27×60 W max (not included)
USA 1×E26×60 W max (not included)

ELEGANTIA TL1 P 

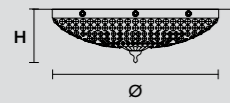


Ø 20 cm / 7.87"
H 35 cm / 13.78"

WW 1×E14×40 W max (not included)
USA 1×E12×40 W max (not included)

Paralumi / Shade PON-BD/20/WH
Paralumi / Shade PON-BD/20/IV

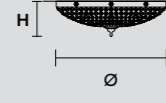
ELEGANTIA PL4 



Ø 60 cm / 23.62"
H 22 cm / 8.66"

WW 4×E27×60 W max (not included)
USA 4×E26×60 W max (not included)

ELEGANTIA PL3 



Ø 40 cm / 15.75"
H 20 cm / 7.87"

WW 3×E27×60 W max (not included)
USA 3×E26×60 W max (not included)

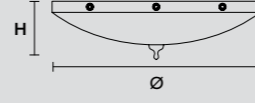
ELEGANTIA PL1 



Ø 20 cm / 7.87"
H 25 cm / 9.84"

WW 1×E27×60 W max (not included)
USA 1×E26×60 W max (not included)

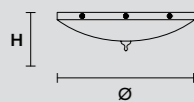
ELEGANTIA PLV4 



Ø 60 cm / 23.62"
H 22 cm / 8.66"

WW 4×E27×60 W max (not included)
USA 4×E26×60 W max (not included)

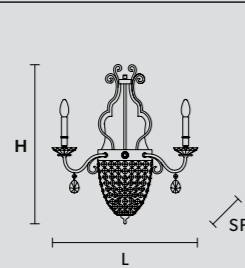
ELEGANTIA PLV3 



Ø 40 cm / 15.75"
H 20 cm / 7.87"

WW 3×E27×60 W max (not included)
USA 3×E26×60 W max (not included)

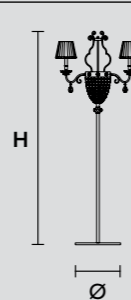
ELEGANTIA A2+1 



L 38 cm / 14.96"
SP 20 cm / 7.87"
H 60 cm / 23.62"

WW 3×E14×40 W max (not included)
USA 3×E12×40 W max (not included)

ELEGANTIA STL3 

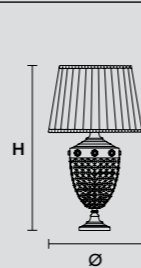


Ø 45 cm / 17.72"
H 180 cm / 70.87"

WW 3×E14×40 W max (not included)
USA 3×E12×40 W max (not included)

Paralumi / Shade PON-BD/16/WH
Paralumi / Shade PON-BD/16/IV


ELEGANTIA TL2 G 




Ø 40 cm / 15.75"
H 75 cm / 29.53"

WW 2×E27×60 W max (not included)
USA 2×E26×60 W max (not included)

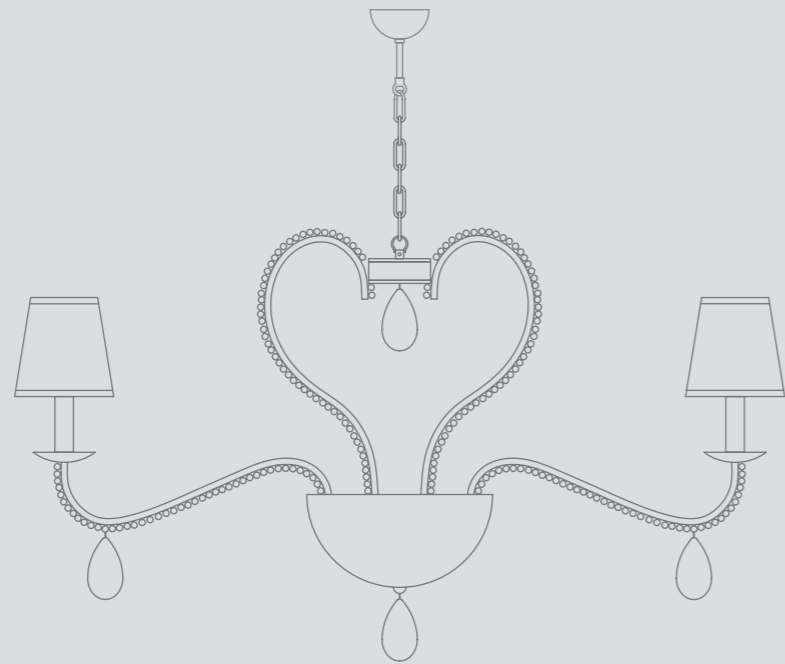
Paralumi / Shade PON-BD/40/WH
Paralumi / Shade PON-BD/40/IV

 : For the US market, refer to the relevant price list.
* ETL only for US market.

 : For the US market, refer to the relevant price list.
* ETL only for US market.

NOBLESSE

design by Masiero Lab



Noblesse 12



Noblesse TL1 G



Noblesse PL6



Noblesse A2



Noblesse 8

NOBLESSE

Il telaio in metallo verniciato è decorato da perle di vetro trasparente.
Paralumi in tessuto shantung.
Pendagli in foglia oro o argento.

Metal frame decorated with transparent glass beads.
Shantung fabric lampshades.
Gold or silver leaf pendants.

Der Rahmen aus lackiertem Metall ist mit transparenten Glasperlen dekoriert.
Lampenschirme aus Shantung.
Blattgold oder Blattsilber Gehängen.

Le châssis en métal verni est décoré avec des perles en verre transparent.
Abat-jours en tissu shantung.
Pampilles en feuille d'or ou d'argent.

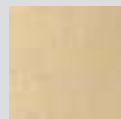
La estructura de metal pintada está decorada con perlas de vidrio transparente.
Pantallas en tejido Shantung.
Piezas colgantes de pan de oro o plata.

МЕТАЛЛИЧЕСКИЙ КАРКАС УКРАШЕН ПРОЗРАЧНЫМИ СТЕКЛЯННЫМИ БУСИНАМИ. АБАЖУРЫ ИЗ ТКАНИ ШАНТУНГ, ПОДВЕСЫ ПОКРЫТЫ СУСАЛЬНЫМ ЗОЛОТОМ ИЛИ СЕРЕБРОМ.

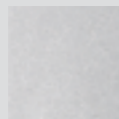
这个灯具结构是金属跟装饰的透明玻璃的珍珠们。这种系列也有材料缎布的灯罩，然而金箔和银箔的吊坠。

إطار معدني مطلي مُزخرف بخرز زجاجي شفاف. عاكس ضوء (أباجورة) من قماش شانتونج. دلايات من أوراق الذهب أو الفضة.

Finishings



V13
Beige e Oro
Ivory and Gold



V97
Bianco e argento
White and silver

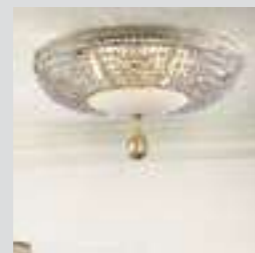
Family



Chandelier



Applique



Ceiling

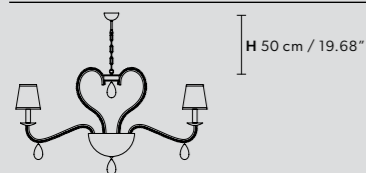


Floor lamp

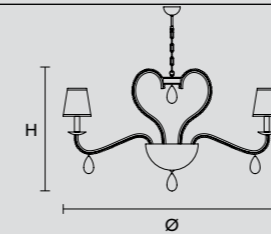


Table lamp

Standard chain for all chandeliers



NOBLESSE 12

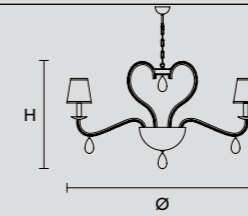


∅ 115 cm / 45.28"
H 72 cm / 28.35"

WW 12×E14×40 W max (not included)
USA 12×E12×40 W max (not included)

Paralumi / Shade SHA-BD/14/IV
Paralumi / Shade SHA-BD/14/WH

NOBLESSE 8

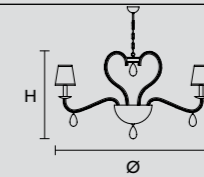


∅ 86 cm / 33.86"
H 62 cm / 24.41"

WW 8×E14×40 W max (not included)
USA 8×E12×40 W max (not included)

Paralumi / Shade SHA-BD/14/IV
Paralumi / Shade SHA-BD/14/WH

NOBLESSE 6

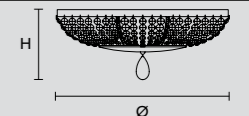


∅ 76 cm / 29.92"
H 62 cm / 24.41"

WW 6×E14×40 W max (not included)
USA 6×E12×40 W max (not included)

Paralumi / Shade SHA-BD/14/IV
Paralumi / Shade SHA-BD/14/WH

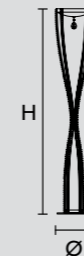
NOBLESSE PL6



∅ 62 cm / 24.41"
H 30 cm / 11.81"

WW 6×E14×40 W max (not included)
USA 6×E12×40 W max (not included)

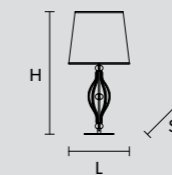
NOBLESSE STL2



∅ 33 cm / 12.99"
H 180 cm / 70.87"

WW 2×R7s×100 W max (not included)
USA 2×R7s×100 W max (not included)

NOBLESSE TL1G

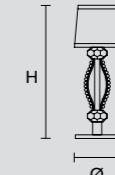


∅ 40 cm / 15.75"
H 85 cm / 33.46"

WW 1×E27×60 W max (not included)
USA 1×E26×60 W max (not included)

Paralumi / Shade SHA-BD/40/IV
Paralumi / Shade SHA-BD/40/WH

NOBLESSE TL1P

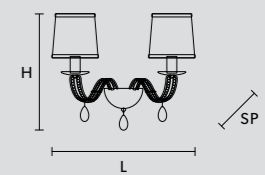


∅ 14 cm / 5.51"
H 38 cm / 14.96"

WW 1×E14×40 W max (not included)
USA 1×E12×40 W max (not included)

Paralumi / Shade SHA-BD/14/IV
Paralumi / Shade SHA-BD/14/WH

NOBLESSE A2

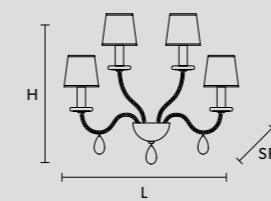


L 46 cm / 17.94"
SP 18 cm / 7.02"
H 40 cm / 15.60"

WW 2×E14×40 W max (not included)
USA 2×E12×40 W max (not included)

Paralumi / Shade SHA-BD/14/IV
Paralumi / Shade SHA-BD/14/WH

NOBLESSE A4



L 50 cm / 19.69"
SP 24 cm / 9.45"
H 48 cm / 18.90"

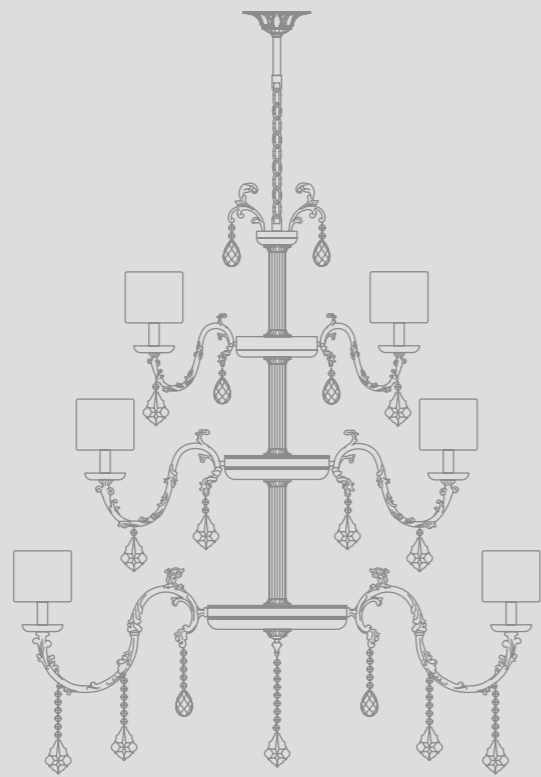
WW 4×E14×40 W max (not included)
USA 4×E12×40 W max (not included)

Paralumi / Shade SHA-BD/14/IV
Paralumi / Shade SHA-BD/14/WH

Ⓢ : For the US market, refer to the relevant price list.
* ETL only for US market.

ETERNITY

design by Masiero Lab

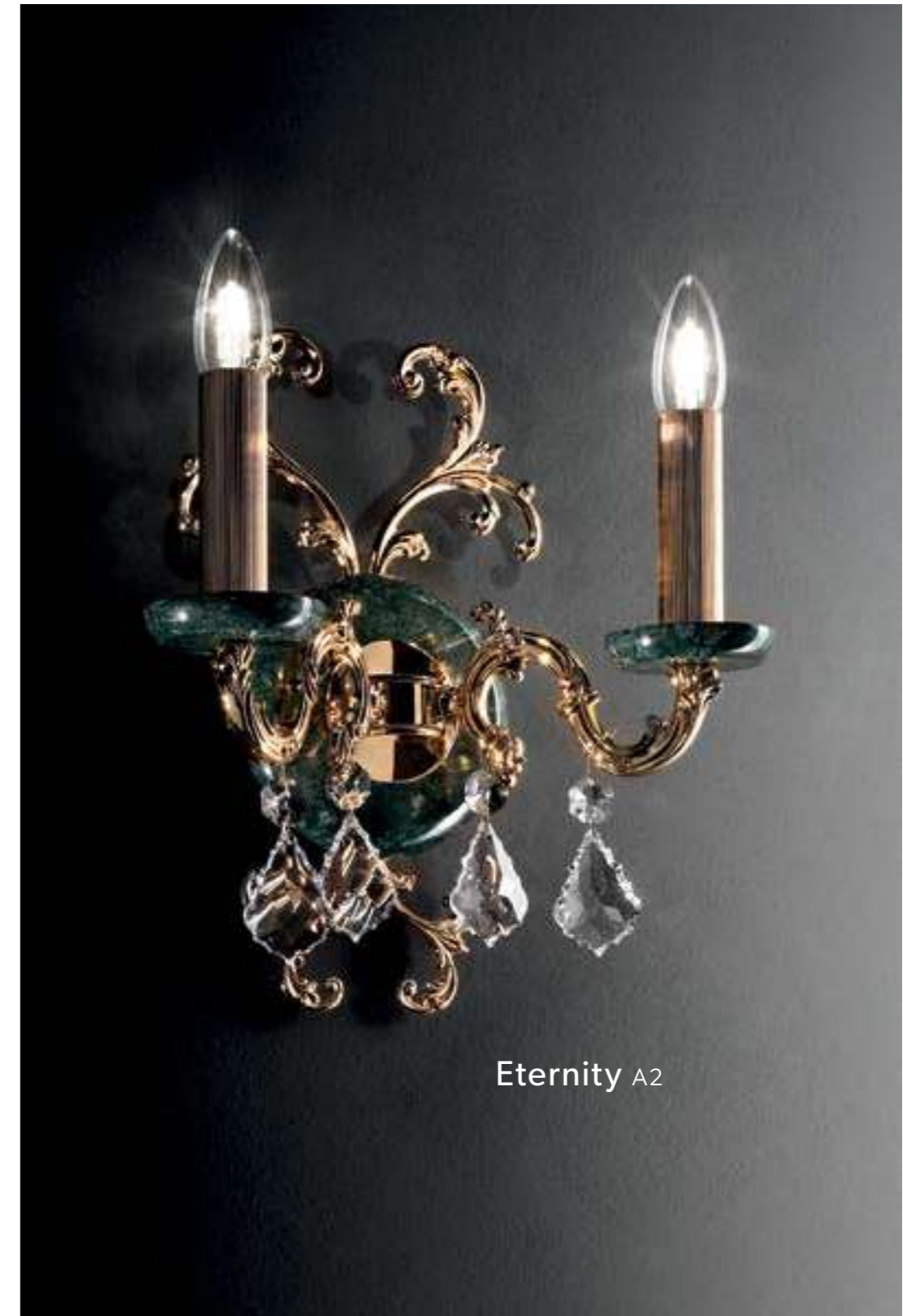


Eternity 12+8+4





Eternity 8+4



Eternity A2

Eternity TL1



ETERNITY

Telaio in fusione di ottone, dischi e piatti di marmo verde Guatemala, o nero Marquina. Pendagli in cristallo trasparente.

Cast brass frame, discs and bobeches in Guatemala green or Marquina black marble. Transparent crystal pendants.

Gestell aus Messingguss, Platten und Schalen aus grünem Guatemala oder schwarzem Marquina- Marmor. Transparente Kristall-Anhänger.

Structure en fusion de laiton, disques et bobeches de marbre vert Guatemala ou de marbre noir Marquina. Pampilles en cristal transparent.

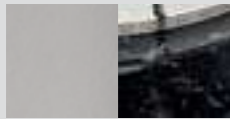
Estructura realizada en fundición de latón, discos y bobeches de mármol verde Guatemala o negro Marquina. Piezas colgantes de cristal transparente.

КАРКАС ИЗ ЛАТУННОГО ЛИТЬЯ С ДИСКАМИ И БЛЮДЦАМИ ИЗ ЗЕЛЕНОГО ГВАТЕМАЛЬСКОГО МРАМОРА, ЛИБО, КАК ВАРИАНТ, ИЗ ЧЕРНОГО МАРКУИНСКОГО МРАМОРА.

这个灯具的结构是黄铜铸件与大理石板(绿色或者蓝色)。而且这种系列也有透明的水晶吊坠。

إطار من صب النحاس الأصفر، وأقراص وأطباق من رخام جواتيمالا الأخضر، أو رخام ماركيينا الأسود. دلايات من الكريستال الشفاف.

Finishings



G04 Cromo lucido + marmo nero Marquina
Shiny chrome + Marquina black marble



G03 Oro lucido + marmo verde Guatemala
Shiny gold + Guatemala green marble

Family



Chandelier



Applique

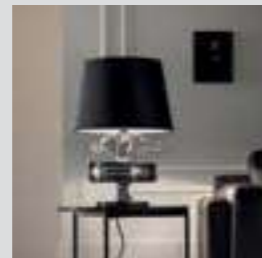
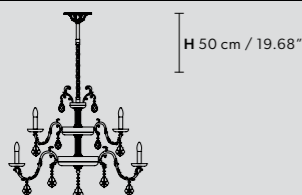
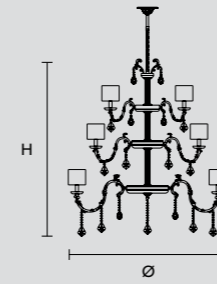


Table lamp

Standard chain for all chandeliers



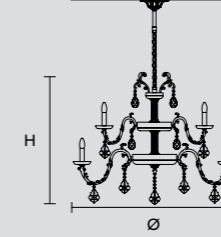
ETERNITY 12+8+4



Ø 150 cm / 56.06"
H 180 cm / 70.87"

WW 24×E14×40 W max (not included)
USA 24×E12×40 W max (not included)
Paralumi / Shade SAT/17/ECRU
Paralumi / Shade SAT/17/BK

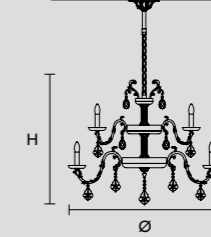
ETERNITY 8+4



Ø 120 cm / 47.24"
H 105 cm / 41.34"

WW 12×E14×40 W max (not included)
USA 12×E12×40 W max (not included)

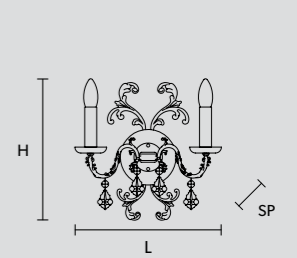
ETERNITY 6+3



Ø 90 cm / 35.43"
H 95 cm / 37.40"

WW 9×E14×40 W max (not included)
USA 9×E12×40 W max (not included)

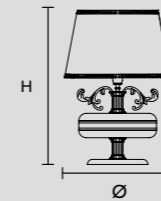
ETERNITY A2



L 31 cm / 12.20"
SP 20 cm / 7.87"
H 36 cm / 14.17"

WW 2×E14×40 W max (not included)
USA 2×E12×40 W max (not included)

ETERNITY TL1



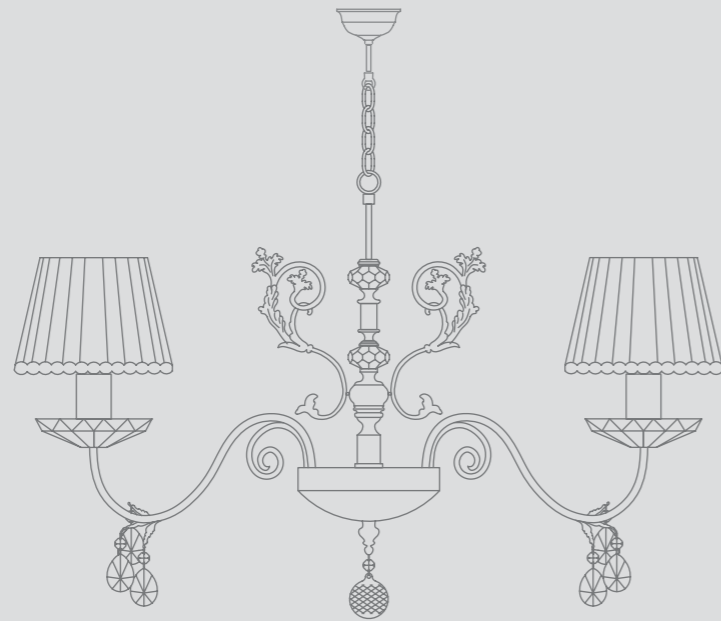
Ø 46 cm / 18.11"
H 62 cm / 24.40"

WW 1×E27×40 W max (not included)
USA 1×E26×40 W max (not included)

Paralumi / Shade SAT/46/WH
Paralumi / Shade SAT/46/BK

PRIMADONNA

design by Masiero Lab



Primadonna 12





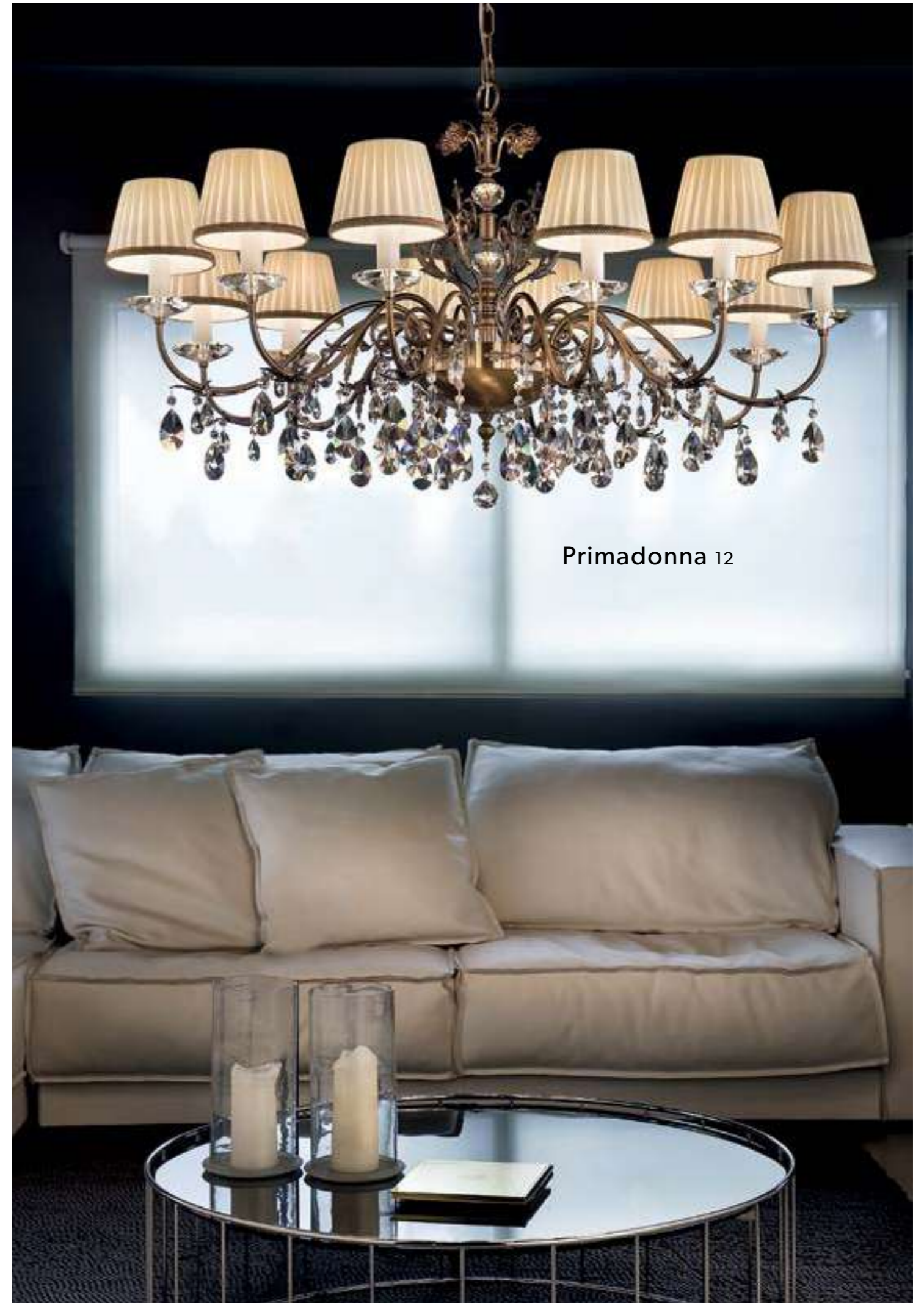
Primadonna TL1 G



Primadonna PL4



Primadonna A2



Primadonna 12



Primadonna TL1 G



Primadonna STL1

PRIMADONNA

Struttura in metallo e decori in fusione d'ottone.
Paralumi in Pongè, pendagli in cristallo trasparente.

Metal frame and brass fusion decorations. Pongè lampshades, transparent crystal pendants.

Metallrahmen und Messingguss. Lampenschirme aus Pongè. Transparente Kristallanhänger.

Structure en métal et décors en fusion en laiton.. Abat-jour en Pongè,. pendatifs en cristal transparent.

Estructura de metal y decoraciones realizadas en fundición de latón.
Pantallas de Pongé, piezas colgantes de cristal transparente.

МЕТАЛЛИЧЕСКИЙ КАРКАС И УКРАШЕНИЯ ИЗ ЛИТОЙ ЛАТУНИ.
АБАЖУРЫ ИЗ ТКАНИ PONGÈ, ПОДВЕСЫ ИЗ ПРОЗРАЧНОГО ХРУСТАЛЯ.

这个灯具的结构是金属，而且有黄铜铸件的装饰。这种系列也有水晶吊坠和合成材料的灯罩。

هيكل معدنية وزخارف من النحاس الأصفر. عاكس ضوء (أباجورة) من قماش بُنْجي، دلايات من الكريستال الشفاف.

Finishings



G01
Brunito
Burnished



G03
Oro lucido
Shiny gold

Family



Chandelier



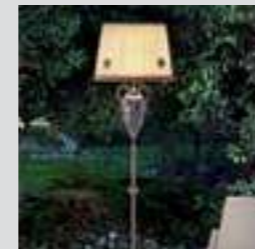
Ceiling



Applique



Table lamp

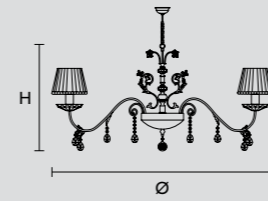


Floor lamp

Standard chain for all chandeliers



PRIMADONNA 12

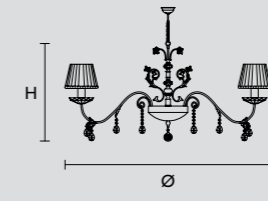


Ø 120 cm / 47.24"
H 65 cm / 25.59"

WW 12×E14×40 W max (not included)
USA 12×E12×40 W max (not included)

Paralumi / Shade PON-BD/16/IV

PRIMADONNA 8

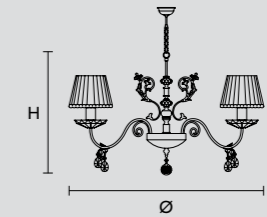


Ø 85 cm / 33.46"
H 55 cm / 21.65"

WW 8×E14×40 W max (not included)
USA 8×E12×40 W max (not included)

Paralumi / Shade PON-BD/16/IV

PRIMADONNA 5

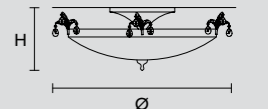


Ø 70 cm / 27.56"
H 50 cm / 19.69"

WW 5×E14×40 W max (not included)
USA 5×E12×40 W max (not included)

Paralumi / Shade PON-BD/16/IV

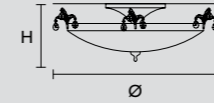
PRIMADONNA PL4



Ø 70 cm / 27.56"
H 25 cm / 9.84"

WW 4×E27×60 W max (not included)
USA 4×E26×60 W max (not included)

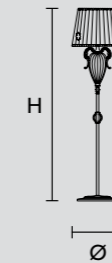
PRIMADONNA PL3



Ø 50 cm / 19.69"
H 23 cm / 9.06"

WW 3×E27×60 W max (not included)
USA 3×E26×60 W max (not included)

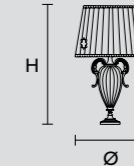
PRIMADONNA STL1



Ø 48 cm / 18.89"
H 180 cm / 70.87"

WW 1×E27×60 W max (not included)
USA 1×E26×60 W max (not included)
Paralumi / Shade PON-BD/48/IV

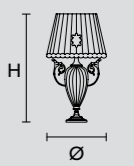
PRIMADONNA TL1G



Ø 40 cm / 15.75"
H 75 cm / 29.53"

WW 1×E27×60 W max (not included)
USA 1×E26×60 W max (not included)
Paralumi / Shade PON-BD/40/IV

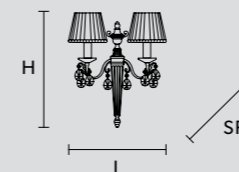
PRIMADONNA TL1P



Ø 16 cm / 6.30"
H 30 cm / 11.81"

WW 1×E14×40 W max (not included)
USA 1×E12×40 W max (not included)
Paralumi / Shade PON-BD/16/IV

PRIMADONNA A2

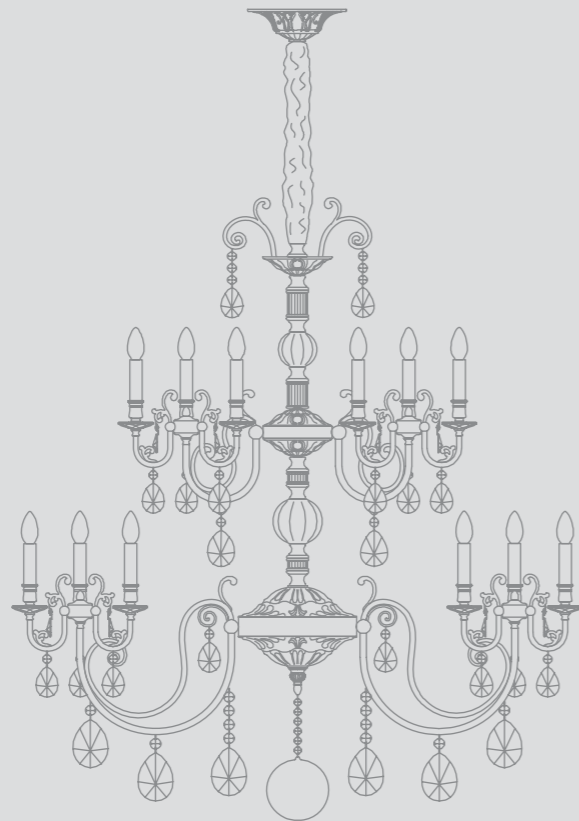


L 40 cm / 15.75"
SP 20 cm / 7.87"
H 50 cm / 19.69"

WW 2×E14×40 W max (not included)
USA 2×E12×40 W max (not included)
Paralumi / Shade PON-BD/16/IV

ZAIRA

design by Masiero Lab



Zaira 27



Zaira A2



Zaira 27

ZAIRA

Telaio in metallo e fusione di ottone. Pendagli in cristallo trasparente.

Metal frame and cast brass. Transparent Crystal pendants.

Metallrahmen und Messingguss. Transparente Kristallanhänger.

Structure en métal et fusion de laiton. Pendentifs en cristal transparent.

Estructura de metal y fundición de latón. Piezas colgantes de cristal transparente.

МЕТАЛЛИЧЕСКИЙ КАРКАС И ЛАТУННОЕ ЛИТЬЕ. ХРУСТАЛЬНЫЕ ПРОЗРАЧНЫЕ ПОДВЕСЫ.

这个灯具的结构是金属跟黄铜铸件。而且这种系列也有透明的水晶吊坠。

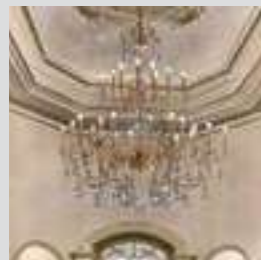
إطار معدني وصب نحاس أصفر. دلايات من الكريستال الشفاف

Finishings



G03
Oro Lucido
Shiny gold

Family

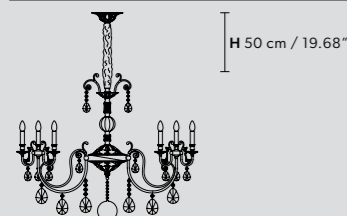


Chandelier

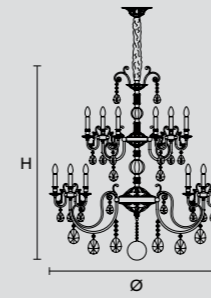


Applique

Standard chain for all chandeliers



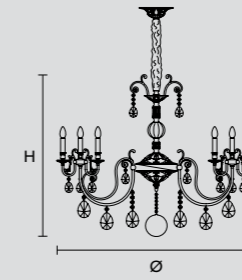
ZAIRA 27



Ø 125 cm / 49.21"
H 130 cm / 51.18"

WW 27×E14×40 W max (not included)
USA 27×E12×40 W max (not included)

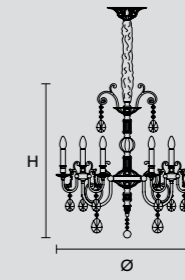
ZAIRA 18



Ø 125 cm / 49.21"
H 90 cm / 35.43"

WW 18×E14×40 W max (not included)
USA 18×E12×40 W max (not included)

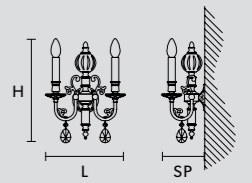
ZAIRA 9



Ø 75 cm / 29.52"
H 70 cm / 27.56"

WW 9×E14×40 W max (not included)
USA 9×E12×40 W max (not included)

ZAIRA A2

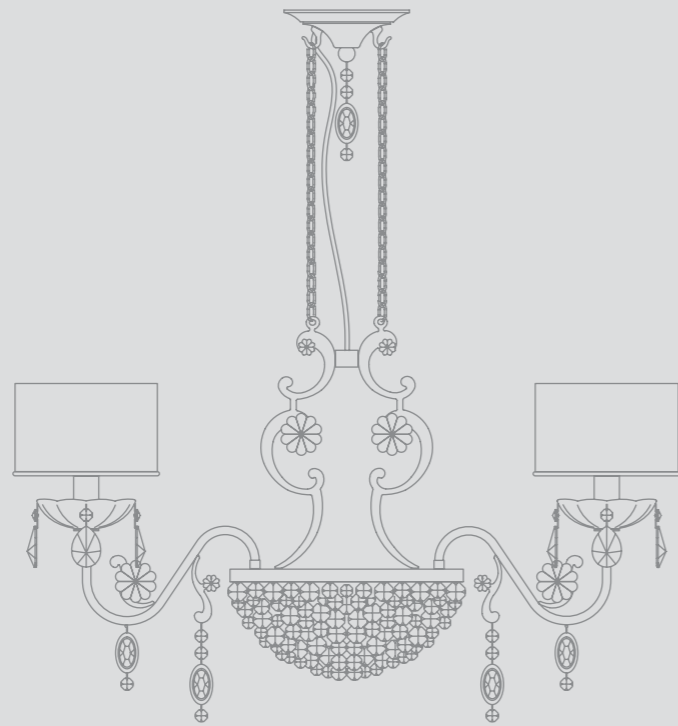


L 28 cm / 11.02"
SP 15 cm / 5.91"
H 38 cm / 14.96"

WW 2×E14×40 W max (not included)
USA 2×E12×40 W max (not included)

ROSEMERY

design by Masiero Lab



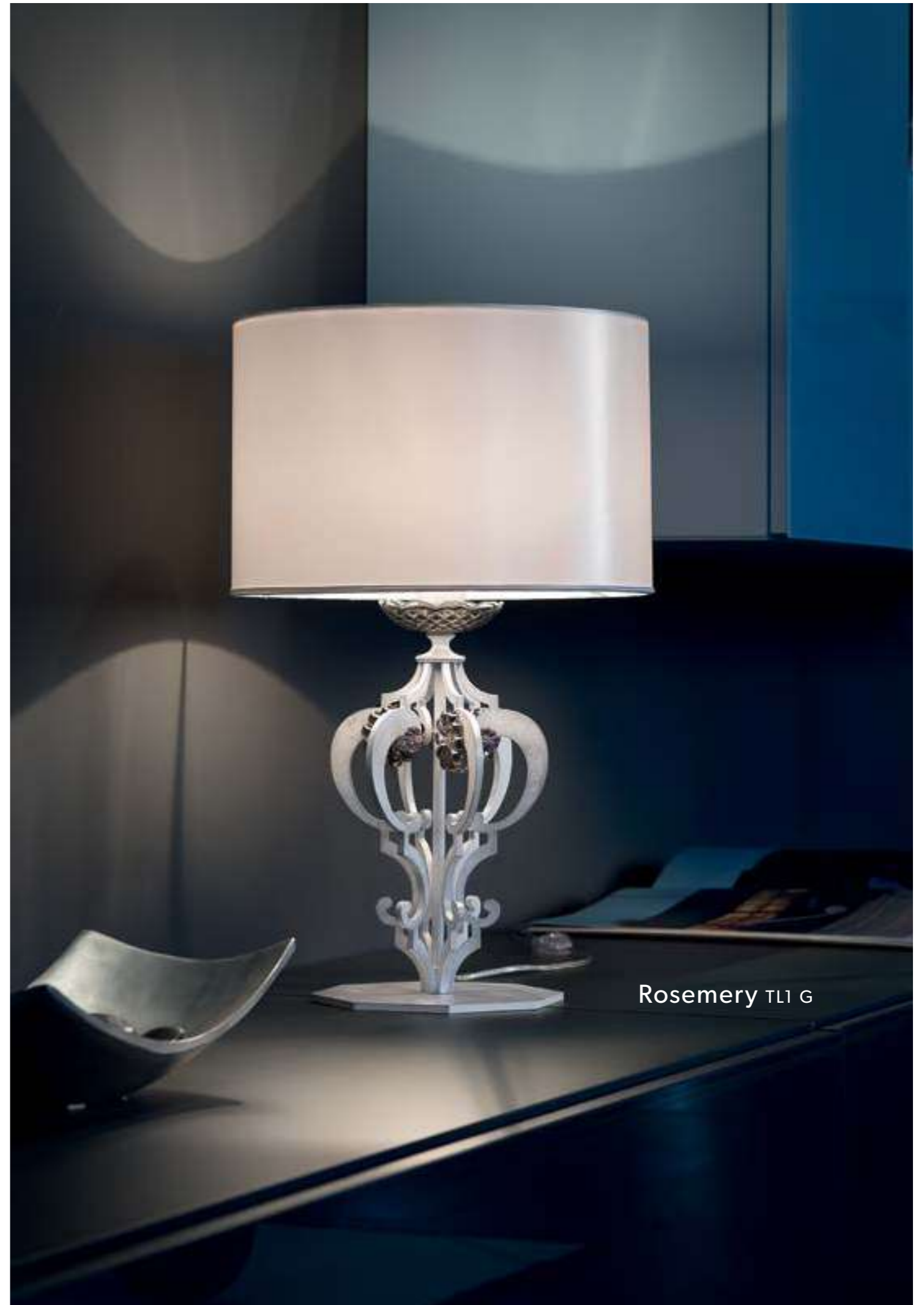
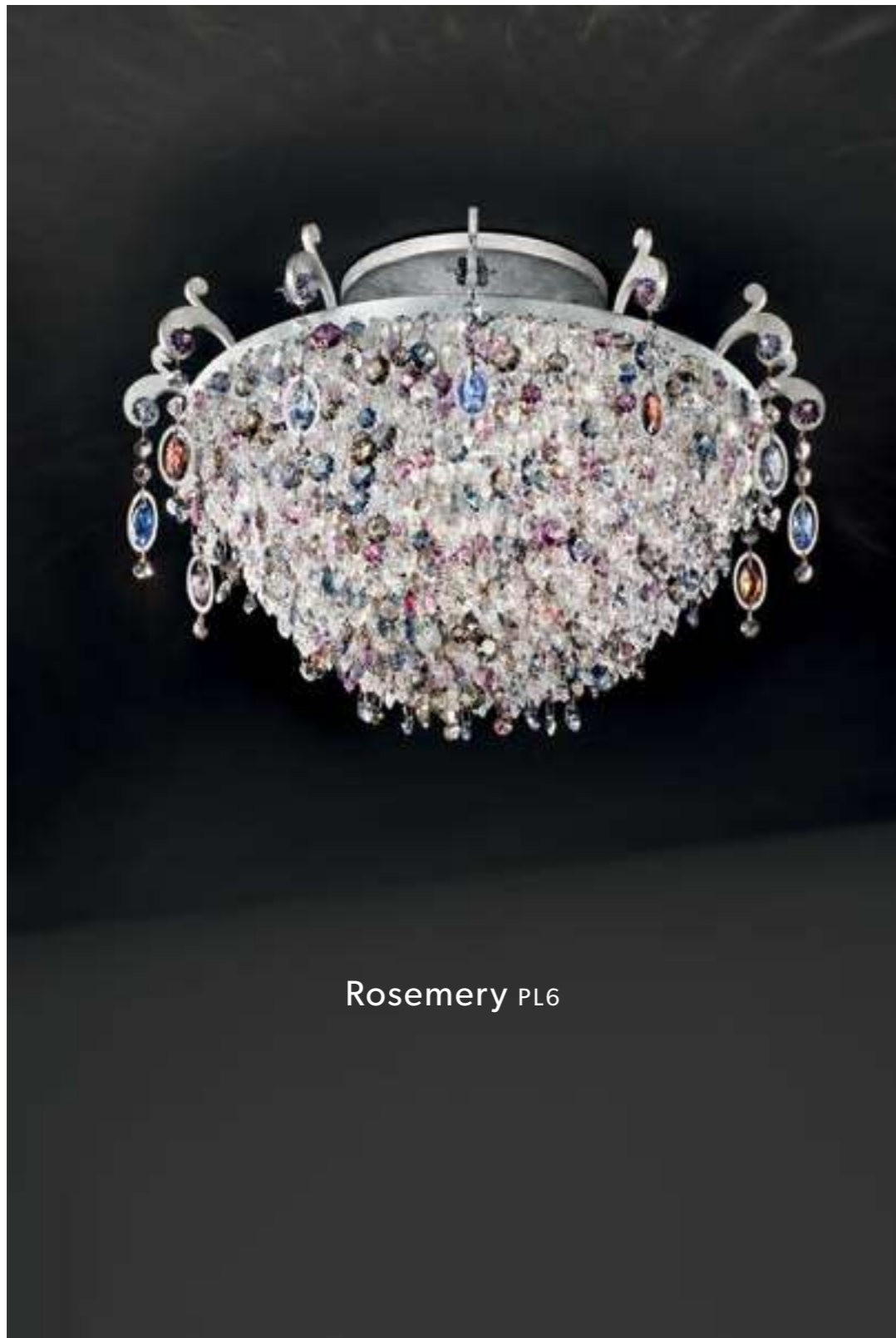
Rosemery 6



Rosemery 12



Rosemery A2





Rosemery 1



Rosemery TL1 P



ROSEMERY

Struttura in metallo con decori in vetro colorato. Pendagli in vetro colorato e paralumi in raso.

Metal frame with colored glass inserts. Colorful glass pendants, satin shades.

Metallstruktur mit Einsätzen aus farbigen Kristallen. Farbiger Glas Behang, Lampenschirme aus Satin.

Structure en métal avec inserts en verre coloré. Les pendentifs sont en verre coloré et les abat-jours sont en satin.

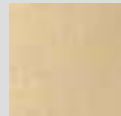
Estructura de metal con decoraciones realizadas en vidrio de color. Piezas colgantes de vidrio de color y pantallas de raso.

МЕТАЛЛИЧЕСКИЙ КАРКАС С ДЕКОРОМ ИЗ ЦВЕТНОГО СТЕКЛА.
ПОДВЕСЫ ИЗ ЦВЕТНОГО СТЕКЛА И АТЛАСНЫЕ АБАЖУРЫ.

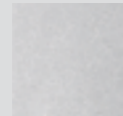
这个灯具结构是金属跟装饰的彩色玻璃。而且这种系列也有彩色的水晶吊坠与材料缎布的灯罩。

هيكل معدني مع زخارف زجاجية ملونة. دلايات من الزجاج الملون وعاكس ضوء (أباجورة) من الساتان.

Finishings



V13
Beige e Oro
Ivory and Gold



V97
Bianco e argento
White and silver

Family



Chandelier



Suspension



Applique



Applique



Ceiling

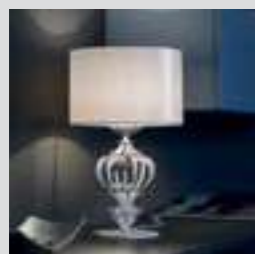
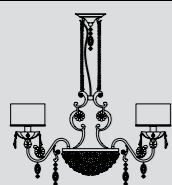


Table lamp

Standard chain/cable for all chandeliers/suspensions

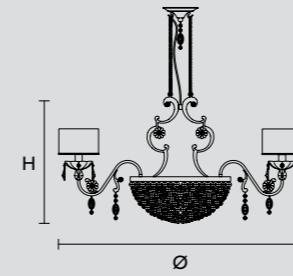


H 50 cm / 19.68"
For Rosemary 12, Rosemary 6,
Rosemary 4, Rosemary 2



H 120 cm / 47.24"
For only Rosemary 1

ROSEMERY 12

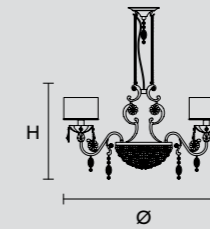


Ø 105 cm / 41.34"
H 55 cm / 21.65"

WW 16xE14x40 W max (not included)
USA 16xE12x40 W max (not included)

Paralumi / Shade SAT/17/ECRU
Paralumi / Shade SAT/17/WH

ROSEMERY 6



Ø 80 cm / 31.50"
H 50 cm / 19.69"

WW 8xE14x40 W max (not included)
USA 8xE12x40 W max (not included)

Paralumi / Shade SAT/17/ECRU
Paralumi / Shade SAT/17/WH

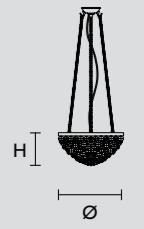
ROSEMERY 4



Ø 45 cm / 17.72"
H 22 cm / 8.66"

WW 4xE14x40 W max (not included)
USA 4xE12x40 W max (not included)

ROSEMERY 2



Ø 30 cm / 11.81"
H 16 cm / 6.30"

WW 2xE14x40 W max (not included)
USA 2xE12x40 W max (not included)

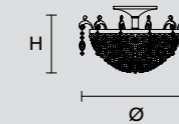
ROSEMERY 1



Ø 23 cm / 9.06"
H 16 cm / 6.30"

WW 1xE27x60 W max (not included)
USA 1xE26x60 W max (not included)

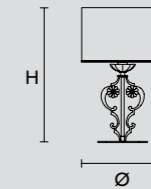
ROSEMERY PL6



Ø 54 cm / 21.26"
H 34 cm / 13.39"

WW 6xE14x40 W max (not included)
USA 6xE12x40 W max (not included)

ROSEMERY TL1 G

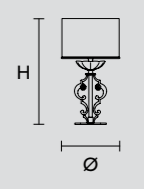


Ø 33 cm / 12.99"
H 54 cm / 21.26"

WW 1xE27x60 W max (not included)
USA 1xE26x60 W max (not included)

Paralumi / Shade SAT/33/ECRU
Paralumi / Shade SAT/33/WH

ROSEMERY TL1 P

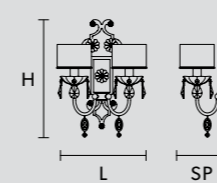


Ø 20 cm / 7.87"
H 36 cm / 14.17"

WW 1xE14x40 W max (not included)
USA 1xE12x40 W max (not included)

Paralumi / Shade SAT/20/ECRU
Paralumi / Shade SAT/20/WH

ROSEMERY A2

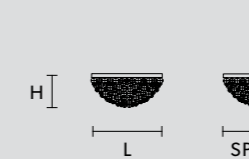


L 32 cm / 12.60"
SP 17 cm / 6.69"
H 43 cm / 16.93"

WW 2xE14x40 W max (not included)
USA 2xE12x40 W max (not included)

Paralumi / Shade SAT/12/ECRU
Paralumi / Shade SAT/12/WH

ROSEMERY A1-2



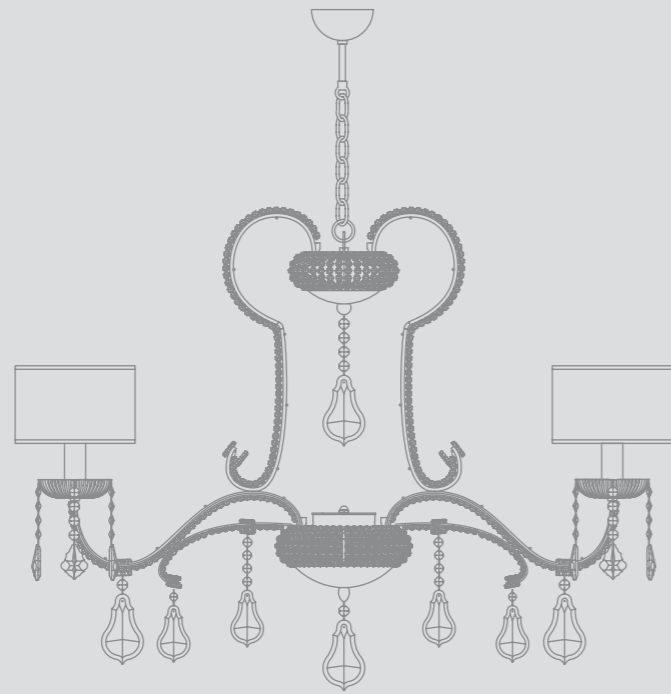
L 30 cm / 11.81"
SP 15 cm / 5.91"
H 16 cm / 6.30"

WW 1xE27x60 W max (not included)
USA 1xE26x60 W max (not included)

Ⓢ : For the US market, refer to the relevant price list.
* ETL only for US market.

GALÁ

design by Masiero Lab



Galá 8+2





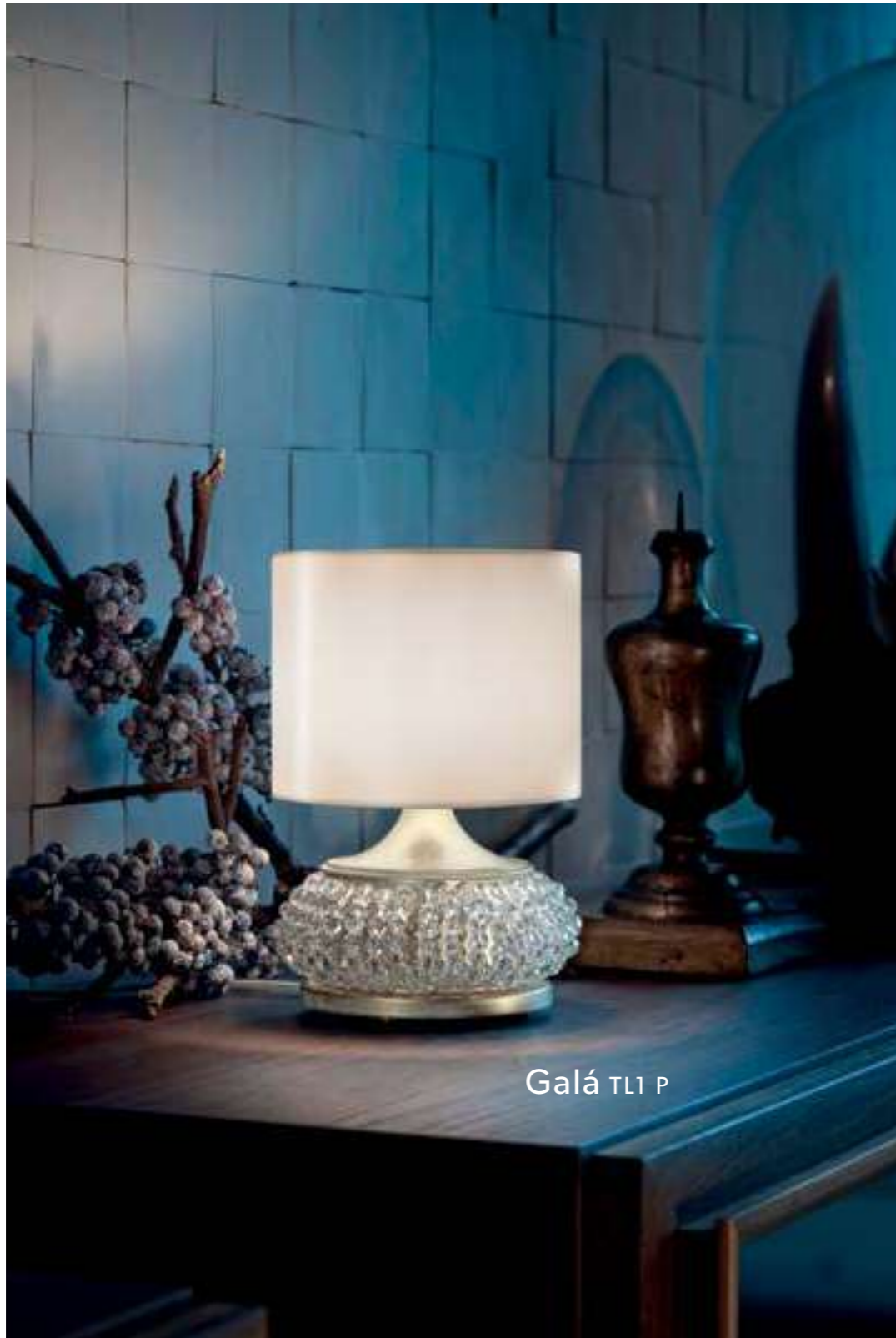
Galá TL1 G



Galá A2



Galá 16+4+3



Galá TL1 P



Galá 8+2

GALÁ

Struttura in metallo decorata da perle e pendagli in cristallo trasparente.
Paralumi in satin.

Metal frame decorated with transparent glass beads and trasparent crystal pendants.
Shantung fabric lampshades.

Metallstruktur, verziert mit Perlen und Anhängern in transparentem Kristall.
Lampenschirme aus Satin.

Structure en métal avec des décorations en perles et pampille en cristaux transparent. Abats jour en satin.

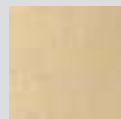
Estructura de metal decorada con perlas y piezas colgantes de cristal transparente.
Pantallas de satén.

МЕТАЛЛИЧЕСКИЙ КАРКАС УКРАШЕН БУСИНАМИ И ПОДВЕСАМИ ИЗ ПРОЗРАЧНОГО ХРУСТАЛЯ. АТЛАСНЫЕ АБАЖУРЫ.

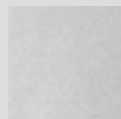
这个灯具结构是金属，然而装饰是透明水晶与珍珠们。这种系列也有材料缎布的灯罩。

هيكل معدني مُزخرف باللؤلؤ ودلايات من الكريستال الشفاف. عاكس ضوء (أباجورة) من الساتان.

Finishings



V13
Beige e Oro
Ivory and Gold



V97
Bianco e argento
White and silver

Family



Chandelier



Applique

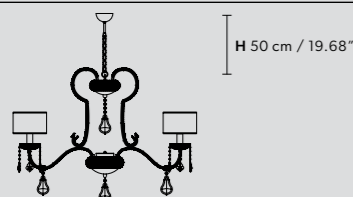


Ceiling

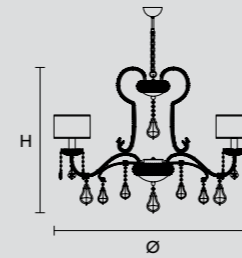


Table lamp

Standard chain for all chandeliers



GALÁ 16+4+3

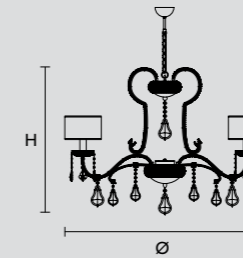


Ø 160 cm / 62.99"
H 115 cm / 45.28"

WW 16×E14×40 W max (not included)
7×G9×40 W max (not included)
USA 16×E12×40 W max (not included)

Paralumi / Shade SAT/17/ECRU
Paralumi / Shade SAT/17/WH

GALÁ 12+3+2

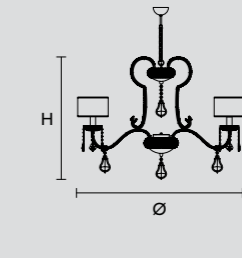


Ø 116 cm / 45.67"
H 76 cm / 29.92"

WW 12×E14×40 W max (not included)
5×G9×40 W max (not included)
USA 12×E12×40 W max (not included)

Paralumi / Shade SAT/17/ECRU
Paralumi / Shade SAT/17/WH

GALÁ 8+2

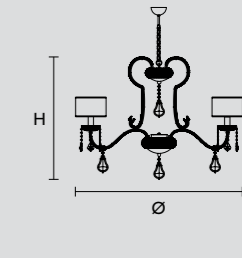


Ø 97 cm / 38.19"
H 67 cm / 26.38"

WW 8×E14×40 W max (not included)
2×G9×40 W max (not included)
USA 8×E12×40 W max (not included)

Paralumi / Shade SAT/17/ECRU
Paralumi / Shade SAT/17/WH

GALÁ 6+2

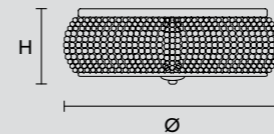


Ø 77 cm / 30.31"
H 55 cm / 21.65"

WW 6×E14×40 W max (not included)
2×G9×40 W max (not included)
USA 6×E12×40 W max (not included)

Paralumi / Shade SAT/17/ECRU
Paralumi / Shade SAT/17/WH

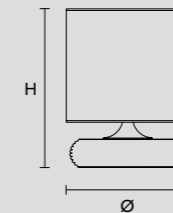
GALÁ PL3



Ø 36 cm / 14.17"
H 12 cm / 4.72"

WW 3×E14×40 W max (not included)
USA 3×E12×40 W max (not included)

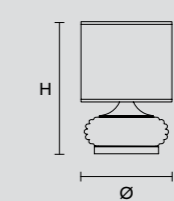
GALÁ TL1G 45



Ø 38 cm / 14.97"
H 45 cm / 17.71"

WW 1×E27×60 W max (not included)
USA 1×E26×60 W max (not included)
Paralumi / Shade SAT/38/ECRU
Paralumi / Shade SAT/38/WH

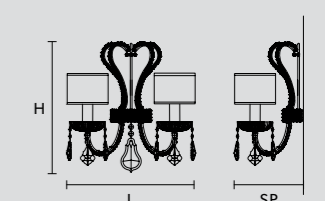
GALÁ TL1P 22



Ø 17 cm / 6.69"
H 22 cm / 8.66"

WW 1×E14×40 W max (not included)
USA 1×E12×40 W max (not included)
Paralumi / Shade SAT/17/ECRU
Paralumi / Shade SAT/17/WH

GALÁ A2



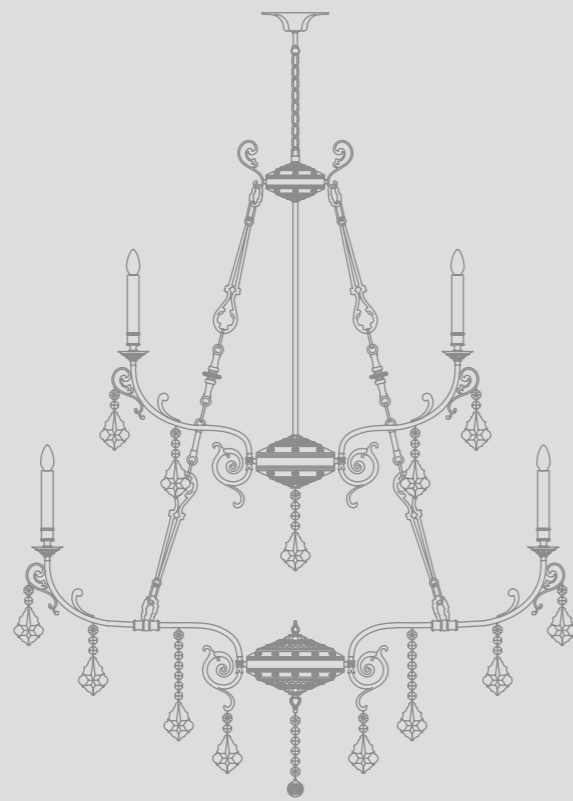
L 35 cm / 13.77"
SP 18 cm / 7.08"
H 35 cm / 13.77"

WW 2×E14×40 W max (not included)
USA 2×E12×40 W max (not included)
Paralumi / Shade SAT/12/ECRU
Paralumi / Shade SAT/12/WH

Ⓜ : For the US market, refer to the relevant price list.
* ETL only for US market.

ODESSA

design by Masiero Lab



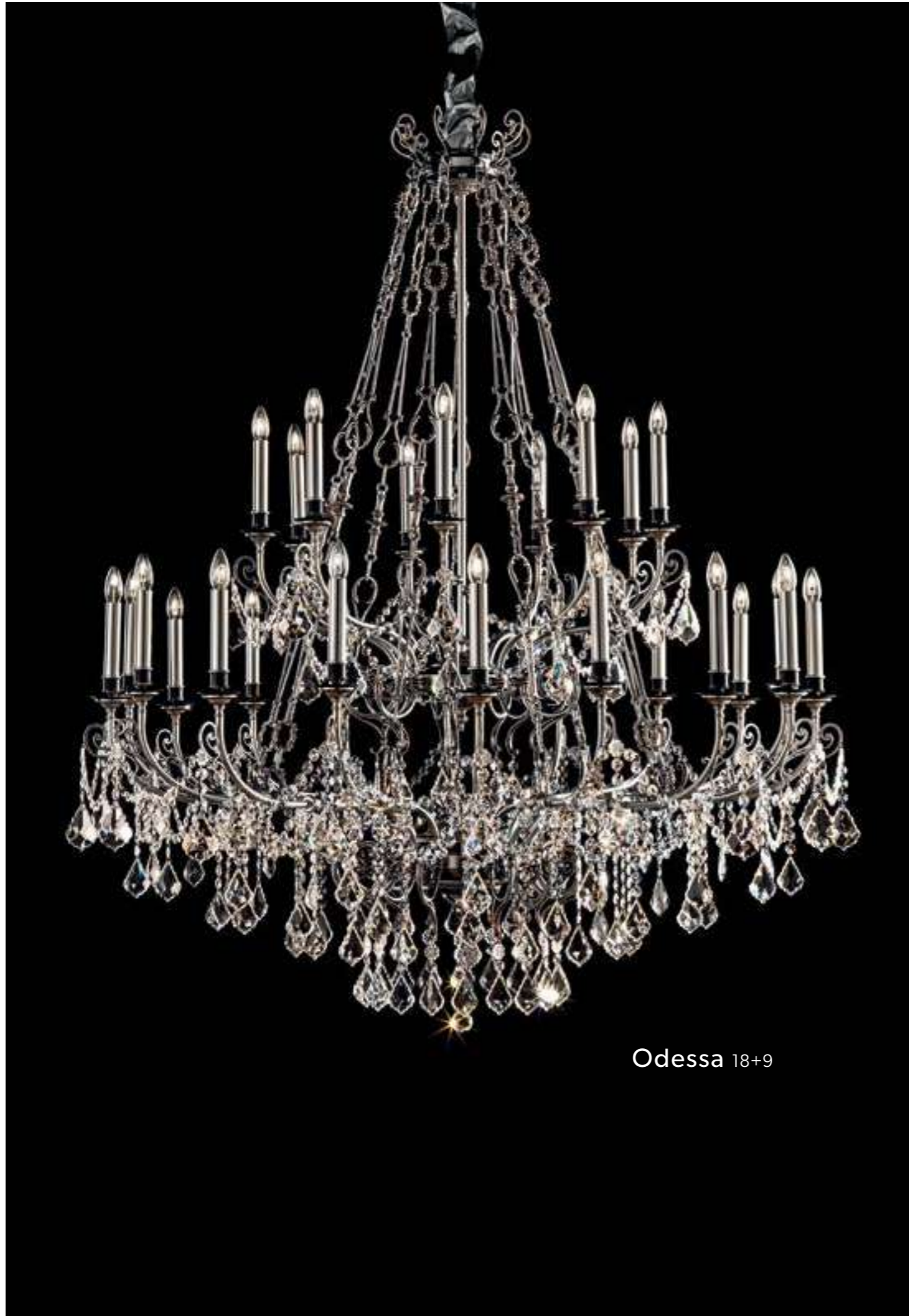
Odessa 12 155



Odessa A5



Odessa A2



Odessa 18+9





Odessa PL8



Odessa 12 95

ODESSA

Telaio in metallo e fusione di ottone. Pendagli in cristallo trasparente.

Metal frame and cast brass. Transparent Crystal pendants.

Metallrahmen und Messingguss. Kristallanhänger.

Structure en métal et fusion de laiton. Pendentifs en cristal transparent.

Estructura de metal y fundición de latón. Piezas colgantes de cristal transparente.

МЕТАЛЛИЧЕСКИЙ КАРКАС И ЛАТУННОЕ ЛИТЬЕ. ХРУСТАЛЬНЫЕ ПОДВЕСЫ

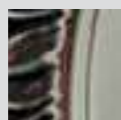
这个灯具的结构是金属跟黄铜铸件。而且这种系列也有透明的水晶吊坠。

إطار معدني وصب نحاس أصفر. دلايات من الكريستال الشفاف

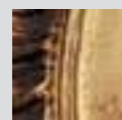
Finishings



G03 Oro Lucido Shiny gold

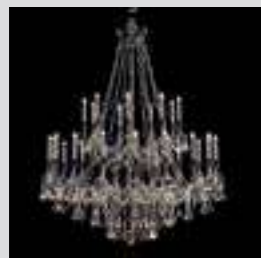


G21 Cromo anticato Antiqued chrome



G20 Oro anticato Antiqued gold

Family



Chandelier

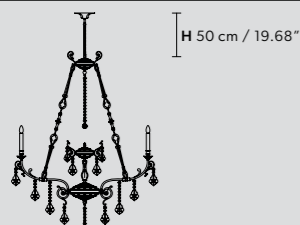


Ceiling

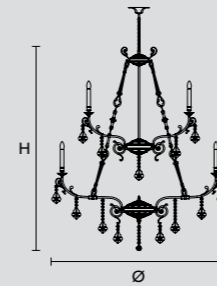


Applique

Standard chain for all chandeliers



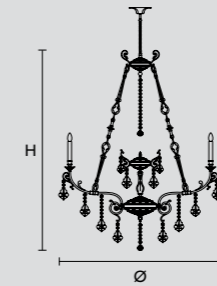
ODESSA 18+9 175



Ø 150 cm / 59.05"
H 175 cm / 68.89"

WW 27×E14×40 W max (not included)
USA 27×E12×40 W max (not included)

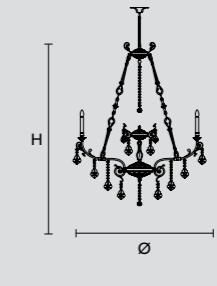
ODESSA 18 175



Ø 150 cm / 59.05"
H 175 cm / 68.89"

WW 18×E14×40 W max (not included)
USA 18×E12×40 W max (not included)

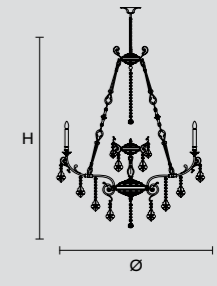
ODESSA 12 155



Ø 120 cm / 47.24"
H 155 cm / 61.02"

WW 12×E14×40 W max (not included)
USA 12×E12×40 W max (not included)

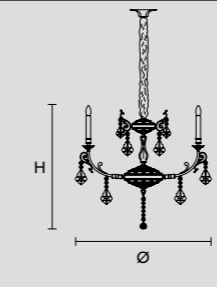
ODESSA 8 100



Ø 90 cm / 35.43"
H 120 cm / 47.24"

WW 8×E14×40 W max (not included)
USA 8×E12×40 W max (not included)

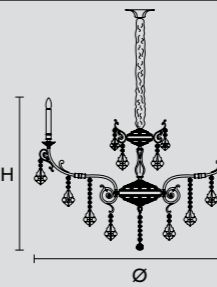
ODESSA 6 65



Ø 70 cm / 27.55"
H 65 cm / 25.59"

WW 6×E14×40 W max (not included)
USA 6×E12×40 W max (not included)

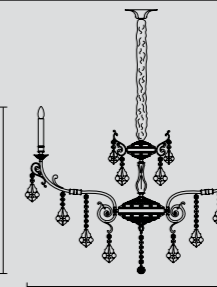
ODESSA 8 80



Ø 90 cm / 35.43"
H 80 cm / 31.49"

WW 8×E14×40 W max (not included)
USA 8×E12×40 W max (not included)

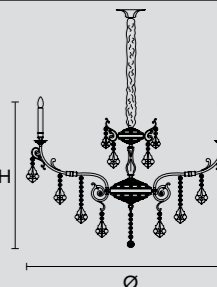
ODESSA 12 95



Ø 120 cm / 47.24"
H 95 cm / 37.40"

WW 12×E14×40 W max (not included)
USA 12×E12×40 W max (not included)

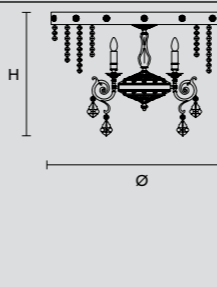
ODESSA 14 90



Ø 150 cm / 59.05"
H 90 cm / 35.43"

WW 14×E14×40 W max (not included)
USA 14×E12×40 W max (not included)

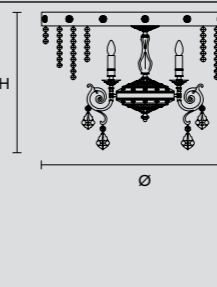
ODESSA PL6 70



Ø 70 cm / 27.56"
H 70 cm / 27.56"

WW 6×E14×40 W max (not included)
USA 6×E12×40 W max (not included)

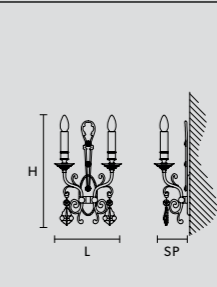
ODESSA PL8 90



Ø 90 cm / 35.43"
H 70 cm / 27.56"

WW 8×E14×40 W max (not included)
USA 8×E12×40 W max (not included)

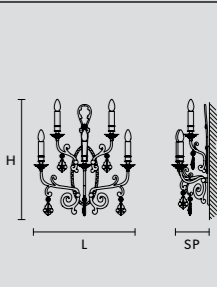
ODESSA A2



L 27 cm / 10.63"
SP 14 cm / 5.51"
H 45 cm / 17.72"

WW 2×E14×40 W max (not included)
USA 2×E12×40 W max (not included)

ODESSA A5



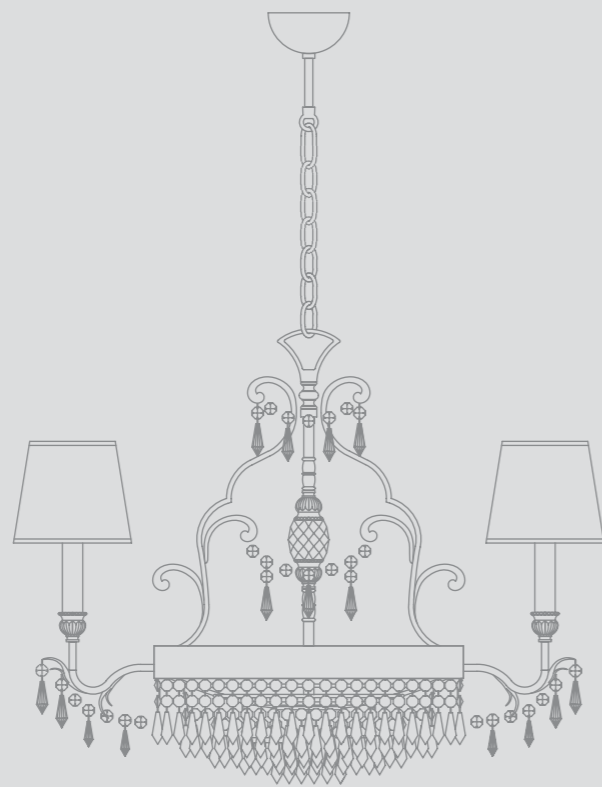
L 45 cm / 17.72"
SP 20 cm / 7.87"
H 50 cm / 19.69"

WW 5×E14×40 W max (not included)
USA 5×E12×40 W max (not included)

Ⓜ : For the US market, refer to the relevant price list.

GLASSÉ

design by Masiero Lab



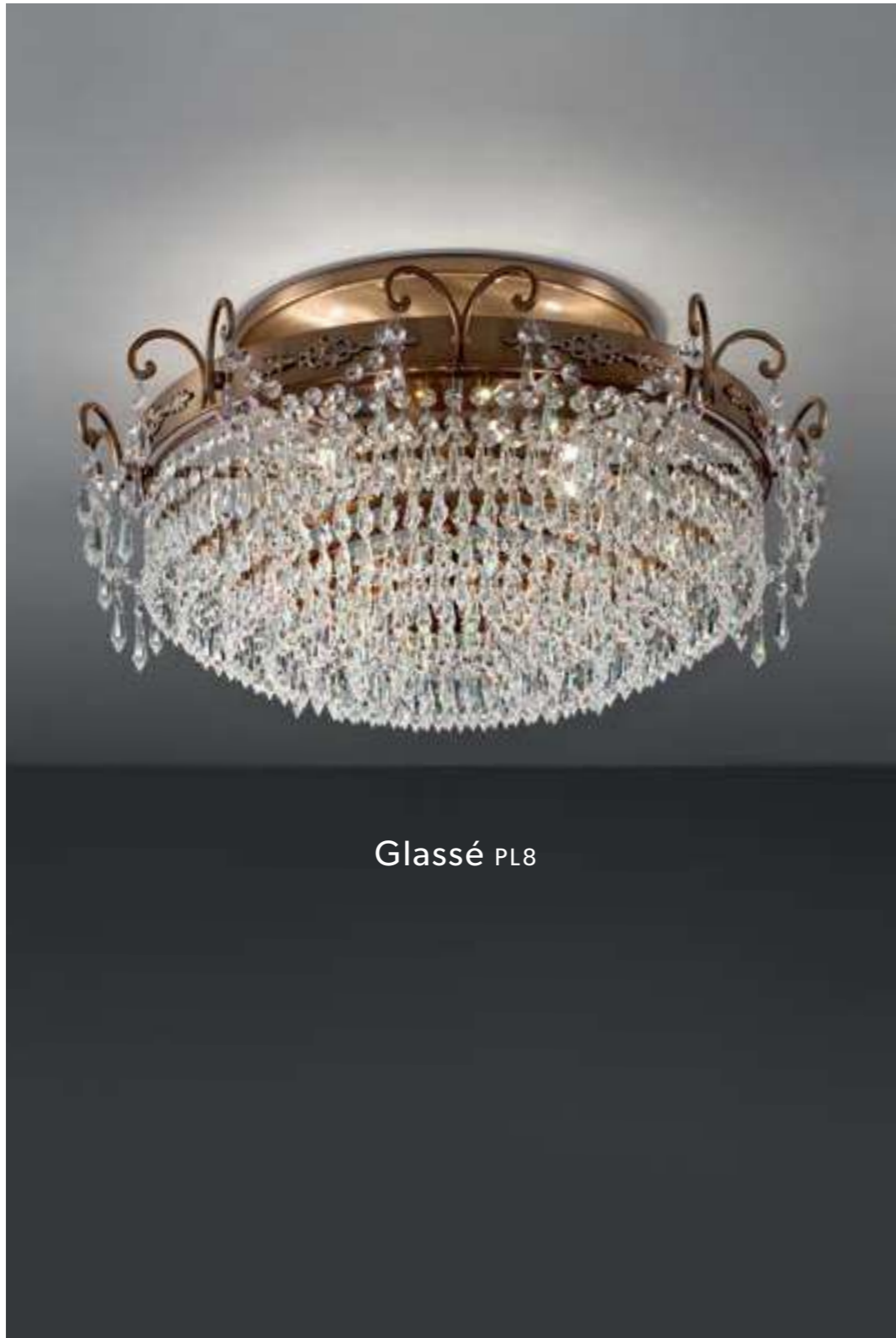
Glassé 6+3



Glassé TL3



Glassé A2+1



Glassé PL8



Glassé STL3



Glassé 8+4



Glassé A4

GLASSÉ

Telaio in metallo
impreziosito da pendenti in
cristallo trasparente.
Paralumi damascati.

The metal structure is
enriched with
transparent crystal pendants.
Damask lampshades.

Die Struktur aus Metall ist
mit zahlreichen Prismen
aus Bleiglas geschmückt.
Lampenschirme aus Damast.

La structure métallique
est agrémentée d'une
pluie de pampilles en
cristal transparent.
Abat-jours damassés.

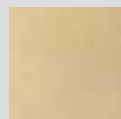
Estructura de metal embellecida
con piezas colgantes de
cristal transparente. Pantallas
adamascadas.

**МЕТАЛЛИЧЕСКИЙ
КАРКАС УКРАШЕН
НИСПАДАЮЩИМИ
ХРУСТАЛЬНЫМИ ПОДВЕСАМИ.
АБАЖУРЫ ИЗ ТКАНИ С
КАМЧАТЫМ УЗОРОМ.**

这个灯具的结构是金属，而且有透
明装饰的装饰。而且这种灯具也有
锦缎面料的灯罩。

إطار معدني مُزخرف بدلايات من
الكريستال الشفاف. عاكس ضوء
(أباجورة) من قماش دمقس.

Finishings



V13
Beige e Oro
Ivory and Gold



G01
Brunito
Burnished

Family



Chandelier



Applique



Ceiling

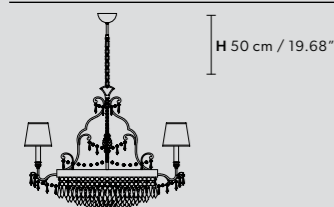


Table lamp

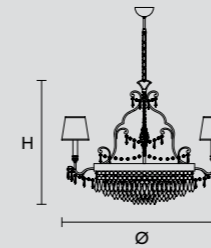


Floor lamp

Standard chain for all chandeliers



GLASSÉ 8+4

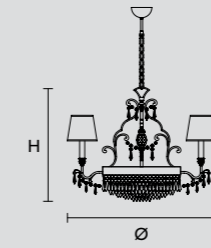


∅ 90 cm / 35.43"
H 70 cm / 27.56"

WW 8×E14×40 W max (not included)*
4×G9×40 W max (not included)
USA 8×E12×40 W max (not included)*
4×G9×40 W max (not included)

Paralumi / Shade DAM/14/IV
*Candle shape necessary for lampshades

GLASSÉ 6+3

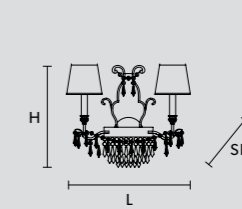


∅ 75 cm / 29.53"
H 60 cm / 23.62"

WW 6×E14×40 W max (not included)*
3×G9×40 W max (not included)
USA 6×E12×40 W max (not included)*
3×G9×40 W max (not included)

Paralumi / Shade DAM/14/IV
*Candle shape necessary for lampshades

GLASSÉ A2+1

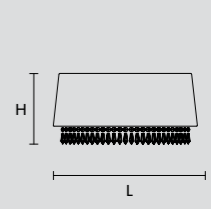


L 40 cm / 15.75"
SP 25 cm / 9.84"
H 40 cm / 15.75"

WW 2×E14×40 W max (not included)*
1×G9×40 W max (not included)
USA 2×E12×40 W max (not included)*
1×G9×40 W max (not included)

Paralumi / Shade DAM/14/IV
*Candle shape necessary for lampshades

GLASSÉ A4

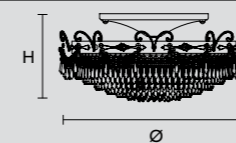


L 50 cm / 19.69"
SP 15 cm / 5.91"
H 25 cm / 9.84"

WW 2×E14×40 W max (not included)
2×G9×40 W max (not included)
USA 2×E12×40 W max (not included)
2×G9×40 W max (not included)

Paralumi / Shade DAM/IV

GLASSÉ PL8



∅ 60 cm / 23.62"
H 30 cm / 11.81"

WW 8×G9×40 W max (not included)
USA 8×G9×40 W max (not included)

GLASSÉ STL3

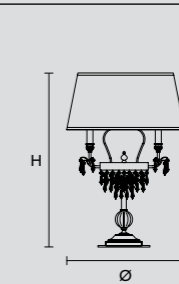


∅ 40 cm / 15.75"
H 170 cm / 66.93"

WW 3×E14×40 W max (not included)
USA 3×E12×40 W max (not included)

Paralumi / Shade DAM/14/IV

GLASSÉ TL3



∅ 40 cm / 15.75"
H 60 cm / 23.62"

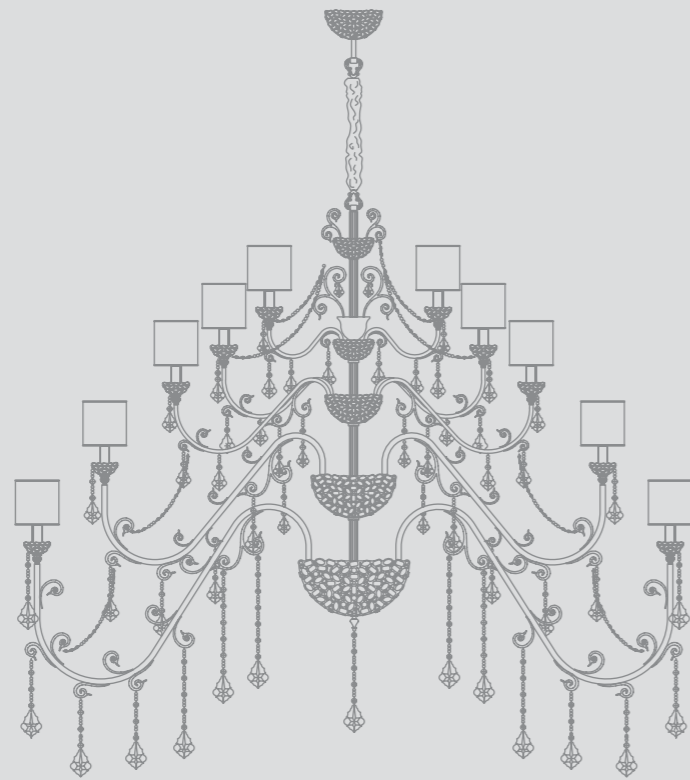
WW 3×E14×40 W max (not included)
USA 3×E12×40 W max (not included)

Paralumi / Shade DAM/IV

Ⓜ : For the US market, refer to the relevant price list.
* ETL only for US market.

IMPERIAL

design by Masiero Lab

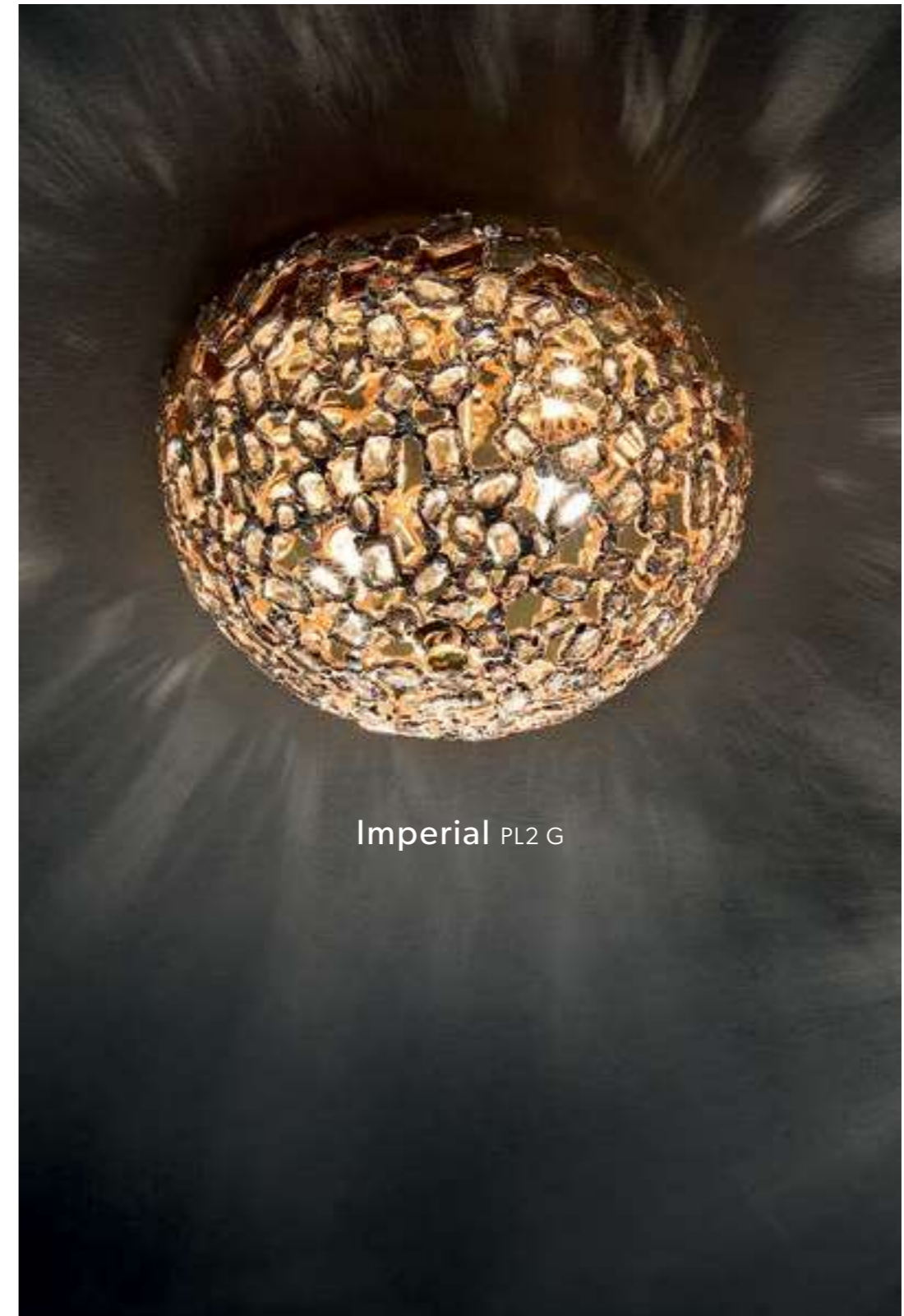


Imperial 16+16+4

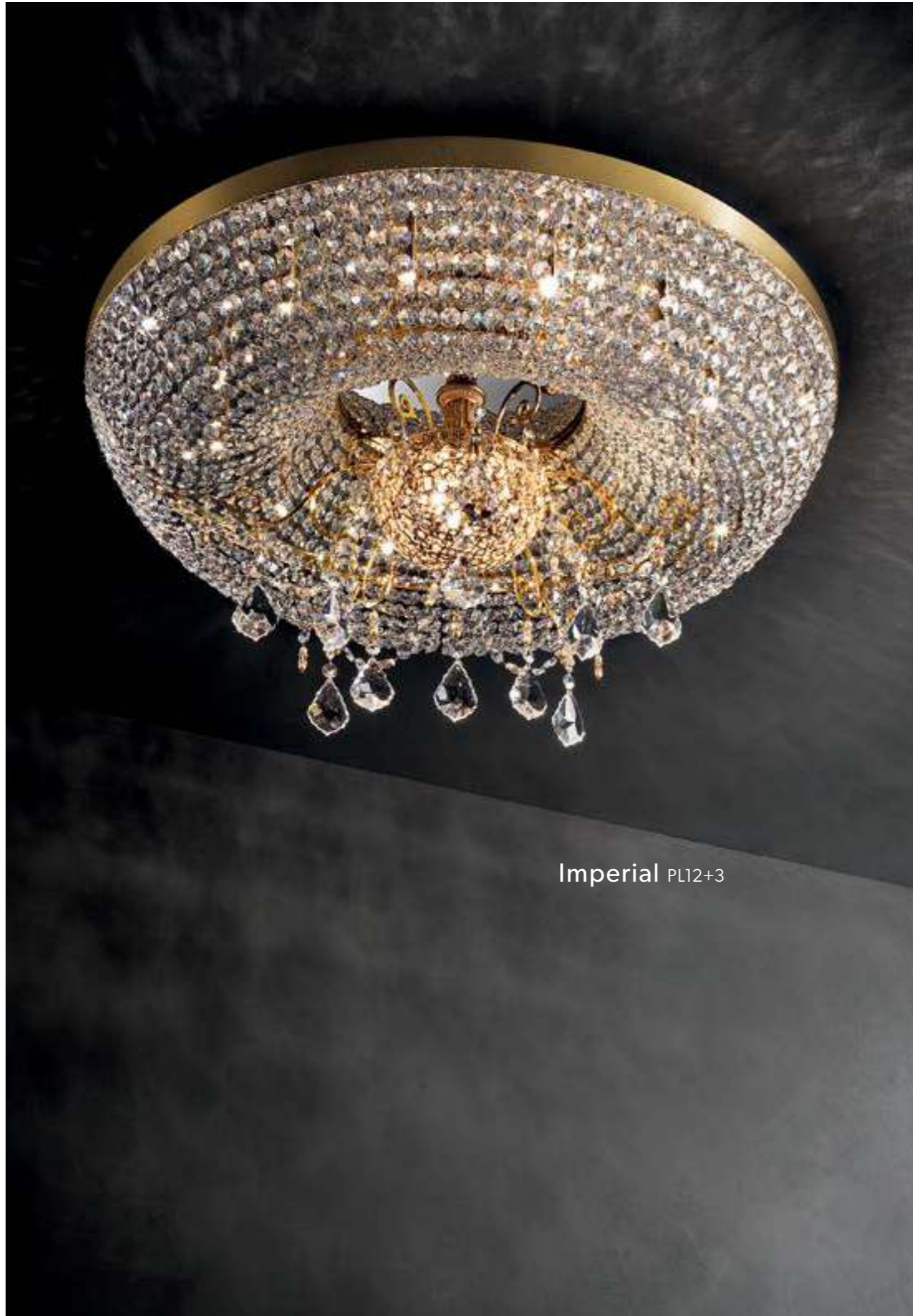




Imperial 12



Imperial PL2 G





Imperial A2



Imperial A1



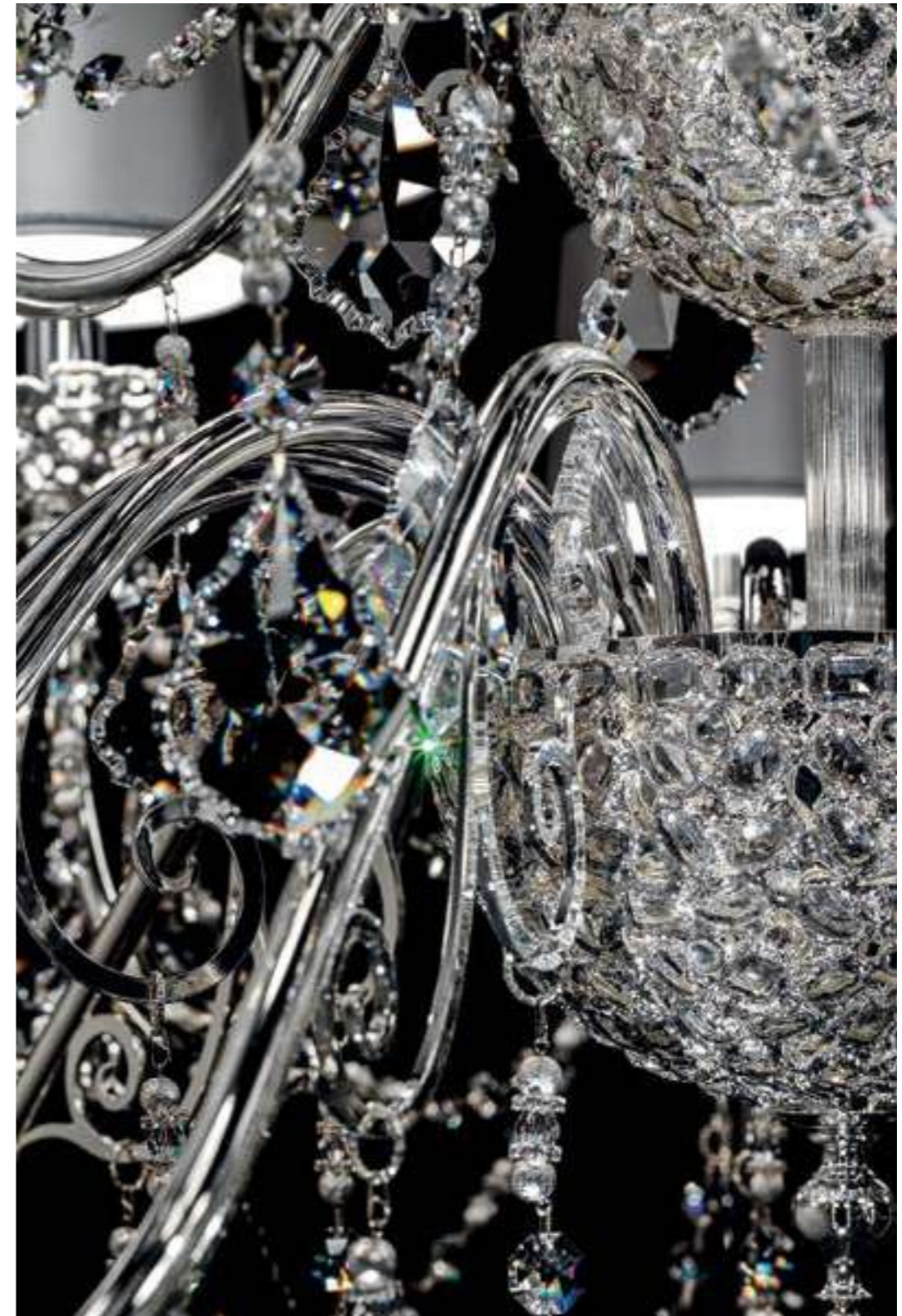
Imperial TL1 G, TL1 M, TL1 P



Imperial TL3



Imperial 16





Imperial STL6

IMPERIAL

Telaio in metallo. Coppe e tazzine decorate con cristalli incastonati. Pendagli in cristallo trasparente.

Metal frames . The goblets and cups are decorated with embedded crystals. Trasparent Crystal pendants.

Metallrahmen. Die Lichtschalen und Tassen sind mit eingebetteten Kristallen verziert. Kristallanhänger.

Structures en métal. Les coupes et les bobèches sont décorées de cristaux sertis. Pendentifs en cristal transparent.

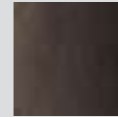
Estructura de metal. Copas y tazas decoradas con cristales engastados. Piezas colgantes de cristal transparente.

МЕТАЛЛИЧЕСКИЙ КАРКАС. ЧАШКИ И БЛЮДЦА УКРАШЕНЫ ВКРАПЛЕННЫМИ КРИСТАЛЛАМИ. ПОДВЕСЫ ИЗ ХРУСТАЛЯ.

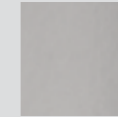
这个灯具结构是金属。这种系列也有透明水晶。

اطار معدني. أكواب وفناجين مُزخرفة بالكريستال المُرصع. دلايات من الكريستال الشفاف.

Finishings



G08
Nickel nero
Black nickel



G04
Cromo lucido
Shiny chrome



G03
Oro lucido
Shiny gold

Family



Chandelier



Ceiling



Applique

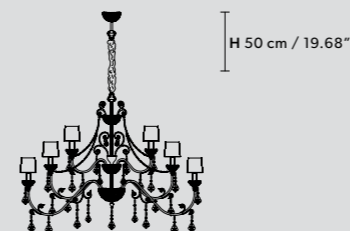



Table lamp

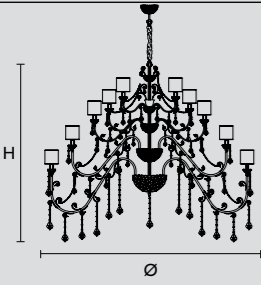


Floor lamp

Standard chain for all chandeliers




IMPERIAL 16+16+4 

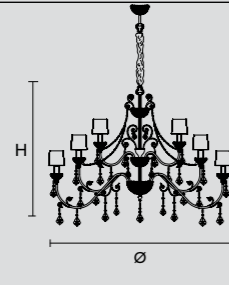


Ø 250 cm / 98.43"
H 200 cm / 78.74"

WW 36×E14×40 W max (not included)
USA 36×E12×40 W max (not included)

Paralumi / Shade SAT/14/ECRU
Paralumi / Shade SAT/14/WH
Paralumi / Shade SAT/14/BK


IMPERIAL 16 

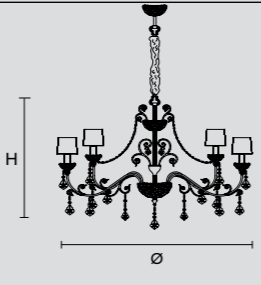


Ø 140 cm / 55.12"
H 110 cm / 43.31"

WW 16×E14×40 W max (not included)
USA 16×E12×40 W max (not included)

Paralumi / Shade SAT/14/ECRU
Paralumi / Shade SAT/14/WH
Paralumi / Shade SAT/14/BK


IMPERIAL 12 

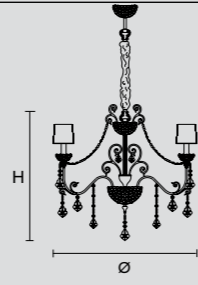


Ø 120 cm / 47.24"
H 90 cm / 35.43"

WW 12×E14×40 W max (not included)
USA 12×E12×40 W max (not included)

Paralumi / Shade SAT/14/ECRU
Paralumi / Shade SAT/14/WH
Paralumi / Shade SAT/14/BK

IMPERIAL 8 

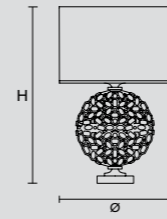


Ø 90 cm / 35.43"
H 85 cm / 33.46"

WW 8×E14×40 W max (not included)
USA 8×E12×40 W max (not included)

Paralumi / Shade SAT/14/ECRU
Paralumi / Shade SAT/14/WH
Paralumi / Shade SAT/14/BK

IMPERIAL TL1 G 

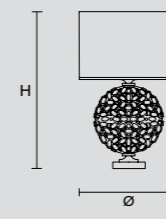


Ø 33 cm / 12.99"
H 50 cm / 19.68"

WW 1×E27×60 W max (not included)
USA 1×E26×60 W max (not included)

Paralumi / Shade SAT/33/ECRU
Paralumi / Shade SAT/33/WH
Paralumi / Shade SAT/33/BK

IMPERIAL TL1 M 

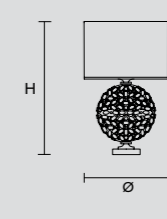


Ø 23 cm / 9.05"
H 37 cm / 14.56"

WW 3×E27×60 W max (not included)
USA 3×E26×60 W max (not included)

Paralumi / Shade SAT/23/ECRU
Paralumi / Shade SAT/23/WH
Paralumi / Shade SAT/23/BK

IMPERIAL TL1 P 

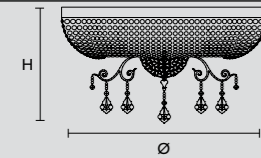


Ø 14 cm / 5.51"
H 26 cm / 10.23"

WW 1×E14×40 W max (not included)
USA 1×E12×40 W max (not included)

Paralumi / Shade SAT/14/ECRU
Paralumi / Shade SAT/14/WH
Paralumi / Shade SAT/14/BK

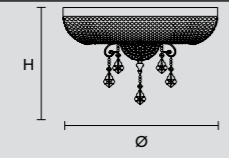
IMPERIAL PL 12+2 



Ø 90 cm / 35.43"
H 45 cm / 17.72"


WW 12×E14×40 W max (not included)
+2×G9×40 W max (included)
USA 12×E12×40 W max (not included)
+2×G9×40 W max (included)

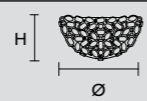
IMPERIAL PL 10+2 



Ø 60 cm / 23.62"
H 35 cm / 13.78"


WW 10×E14×40 W max (not included)
+2×G9×40 W max (included)
USA 10×E12×40 W max (not included)
+2×G9×40 W max (included)

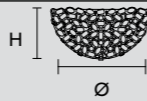
IMPERIAL PL2 P 



Ø 17 cm / 6.69"
H 10 cm / 3.93"


WW 2×G9×40 W max (not included)
USA 2×G9×40 W max (not included)

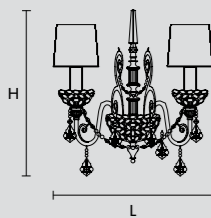
IMPERIAL PL2 G 



Ø 22 cm / 8.66"
H 13 cm / 5.11"

WW 2×G9×40 W max (not included)
USA 2×G9×40 W max (not included)


IMPERIAL A2 

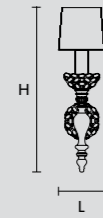


L 50 cm / 19.69"
SP 18 cm / 7.09"
H 46 cm / 18.11"

WW 2×E14×40 W max (not included)
USA 2×E12×40 W max (not included)

Paralumi / Shade SAT/14/ECRU
Paralumi / Shade SAT/14/WH
Paralumi / Shade SAT/14/BK


IMPERIAL A1 



L 14 cm / 5.51"
SP 17 cm / 6.69"
H 40 cm / 15.75"

WW 1×E14×40 W max (not included)
USA 1×E12×40 W max (not included)

Paralumi / Shade SAT/14/ECRU
Paralumi / Shade SAT/14/WH
Paralumi / Shade SAT/14/BK

IMPERIAL TL3 

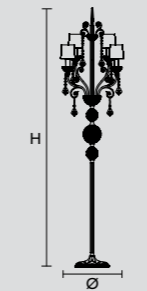


Ø 42 cm / 16.54"
H 76 cm / 29.92"

WW 3×E14×40 W max (not included)
USA 3×E12×40 W max (not included)

Paralumi / Shade SAT/14/ECRU
Paralumi / Shade SAT/14/WH
Paralumi / Shade SAT/14/BK


IMPERIAL STL6 




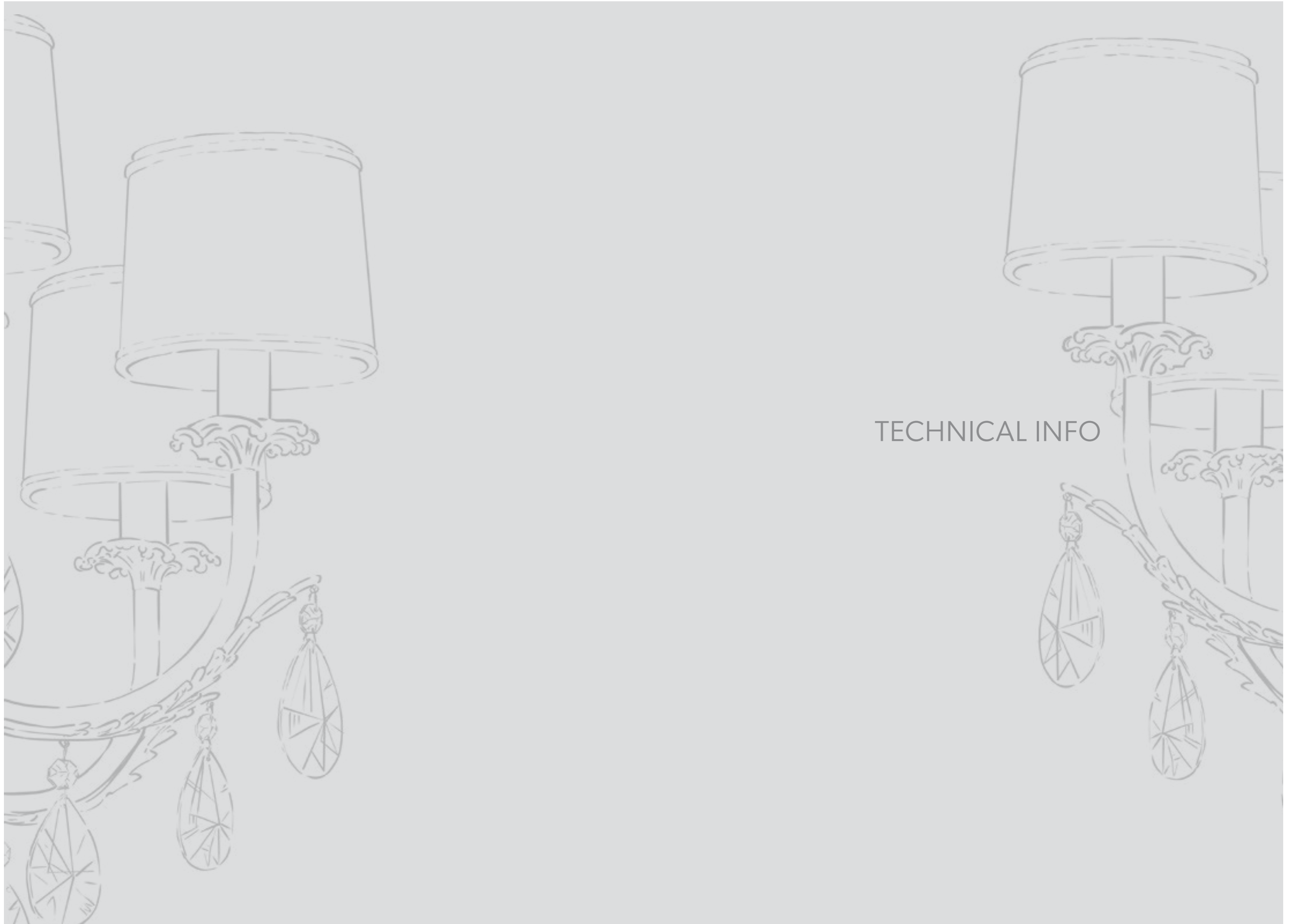
Ø 55 cm / 21.65"
H 215 cm / 84.65"

WW 6×E14×40 W max (not included)
USA 6×E12×40 W max (not included)

Paralumi / Shade SAT/12/ECRU
Paralumi / Shade SAT/12/WH
Paralumi / Shade SAT/12/BK

 : For the US market, refer to the relevant price list.
* ETL only for US market.

 : For the US market, refer to the relevant price list.
* ETL only for US market.



TECHNICAL INFO

FINITURE / FINISHING

Verniciati/ Painted



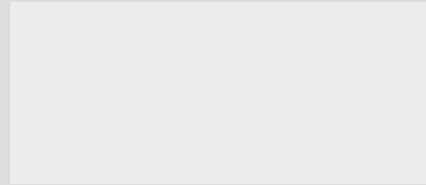
V13 Avorio e oro
Ivory and gold



V71 Nickel opaco verniciato
Painted matt nickel



V90 Nero opaco
Matt black



V95 Bianco opaco
Matt white



V97 Bianco e argento
White and silver

Decorazione a foglia / Leaf decoration



F01 Foglia oro
Gold leaf



F02 Foglia argento
Silver leaf

FINITURE / FINISHING

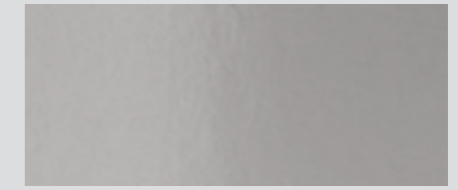
Bagno galvanico / Galvanic Bath



G01 Brunito
Burnished



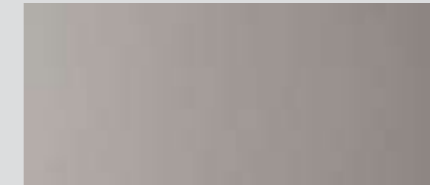
G03 Oro lucido
Shiny gold



G04 Cromo lucido
Shiny chrome



G05 Oro opaco
Matt gold



G06 Cromo opaco
Matt chrome



G08 Nickel nero
Black nickel



G20 Oro anticato
Antiqued gold



G21 Cromo anticato
Antiqued chrome

CE

Attesta la conformità del prodotto alle disposizioni delle Direttive comunitarie.

It certifies the conformity of the products to the European Community provisions.

Il atteste la conformité du produit aux dispositions des directives communitaires.

Konformität des Produktes mit den Richtlinien der europäischen Gemeinschaft.

НАСТОЯЩИМ ПОДТВЕРЖДАЕТСЯ СООТВЕТСТВИЕ ПРОДУКЦИИ ПОЛОЖЕНИЯМ ДИРЕКТИВ ЕС.

Certifica la conformidad del producto según las disposiciones de las directivas comunitarias.

CE标记是指产品的制造商证明该产品符合适用的EC指令的所有基本要求。

يُشهد بمطابقة المنتج لأحكام توجيهات المجتمع الأوروبي.



Il logo "ETL" si riferisce agli articoli che possono essere modificati con componenti certificati ETL. L'elenco degli articoli ETL si riferisce a prodotti testati e valutati in base agli standard di sicurezza del mercato statunitense. Per il mercato USA fare riferimento al listino dedicato.

"ETL" logos refers to articles which can be modified with ETL- compliance components. The "ETL" listing articles stands for tested and evaluated product to recognised US safety standards. For the US market, refer to the relevant price list.

"ETL" logo se réfère aux articles qui peuvent être modifiées par des composants certifiés ETL. la liste des articles ETL se réfère à des produits testés et évalués selon les normes de sécurité du marché américain. Pour le marché américain se référer à la liste des prix.

Das "ETL"-Logo bezieht sich auf Artikel, die mit ETL-zertifizierten Komponenten modifiziert werden können. Die Liste der ETL-Artikel bezieht sich auf Produkte, die nach den Sicherheitsstandards des US-Marktes getestet und bewertet wurden. Für den US-Markt beachten Sie bitte die entsprechende Preisliste.

ЛОГОТИП «ETL» ОТНОСИТСЯ К ЭЛЕМЕНТАМ, КОТОРЫЕ МОГУТ БЫТЬ МОДИФИЦИРОВАННЫ С ПОМОЩЬЮ СЕРТИФИЦИРОВАННЫХ ETL КОМПОНЕНТОВ. СПИСОК ЭЛЕМЕНТОВ ETL ОТНОСИТСЯ К ПРОДУКЦИИ, ПРОТЕСТИРОВАННОЙ И ОЦЕНЕННОЙ В СООТВЕТСТВИИ С ПРИЗНАННЫМИ СТАНДАРТАМИ БЕЗОПАСНОСТИ США. ДЛЯ ПОТРЕБИТЕЛЕЙ НАХОДЯЩИХСЯ В США СМ. СООТВЕТСТВУЮЩИЙ ПРАЙС-ЛИСТ.

El logo "ETL" indica los artículos, que pueden modificarse con componentes certificados ETL. La lista de los artículos ETL se refiere a los productos sometidos a prueba y evaluados en función de los estándares de seguridad del mercado estadounidense. Consultar la lista de precios específica para el mercado de los Estados Unidos.

"ETL" 徽标是指可以使用ETL认证的组件进行修改的项目。 ETL项目列表是指根据美国市场的安全标准进行测试和评估的产品。 对于美国市场, 请参考美国市场价格表。

يشير شعار «ETL» إلى المنتجات التي يمكن تعديلها باستخدام مكونات مُعتمدة من ETL. تشير قائمة منتجات ETL إلى المنتجات التي تم اختبارها وتقييمها وفقًا لمعايير السلامة في السوق الأمريكي. بالنسبة لسوق الولايات المتحدة الأمريكية، يُرجى الرجوع إلى قائمة الأسعار المُخصصة.

Im

Flusso luminoso nominale. L'indicazione si riferisce al valore in assenza di rifrazione, come dichiarato dal produttore del componente.

Nominal luminous flux. It refers to the value without any refraction, as declared by the component manufacturer.

L'unité SI de flux lumineux. L'indication correspond à la valeur en l'absence de réfraction, comme indiqué par le fabricant du composant.

Die Maßeinheit für den Lichtstrom. Die Angabe bezieht sich auf den Wert in der Abwesenheit von Brechung, wie vom Hersteller der Komponente angegeben.

НОМИНАЛЬНЫЙ СВЕТОВОЙ ПОТОК. УКАЗАНИЕ ОТНОСИТСЯ К ЗНАЧЕНИЮ В ОТСУТСТВИЕ РЕФРАКЦИИ, КАК ЗАЯВЛЕНО ПРОИЗВОДИТЕЛЕМ КОМПОНЕНТОВ.

Flujo luminoso nominal. La indicación se refiere al valor sin refracción, como declarado por el fabricante del componente.

标称光通量。指示是指组件制造商声明的没有折射的值。

التدفق الضوئي الاسمي. يشير المؤشر إلى القيمة في حالة عدم وجود انكسار للضوء، كما هو مُعلن من قبل الشركة المصنعة للعنصر.

MASIERO

Masiero si riserva il diritto di apportare ai propri articoli, senza nessun preavviso, qualsiasi modifica ritenesse opportuna.

Masiero reserves the right to introduce any changes to its own products, without notice in advance.

Masiero se réserve le droit d'apporter une quelconque modification à les modèles sans préavis.

Masiero behalt sich das Recht vor änderungen vorzunehmen, ohne sofortige Benachrichtigung.

КОМПАНИЯ MASIERO ОСТАВЛЯЕТ ЗА СОБОЙ ПРАВО БЕЗ ПРЕДВАРИТЕЛЬНОГО УВЕДОМЛЕНИЯ, ЕСЛИ ЭТО БУДЕТ СОЧЕНО ЦЕЛЕСООБРАЗНЫМ, ВНОСИТЬ В СОБСТВЕННЫЕ МОДЕЛИ ЛЮБЫЕ ИЗМЕНЕНИЯ.

Masiero se reserva el derecho de aportar modificaciones consideradas oportunas a sus artículos sin preaviso.

Masiero 保留对其认为适当的任何更改的权利, 恕不另行通知。

تحتفظ شركة مازيرو "Masiero" بالحق في إجراء أي تعديلات تراها مناسبة على منتجاتها، دون إشعار مسبق.

Masiero srl

via Peschiere, 53
31032 Casale sul Sile
Treviso, Italy
T +39 0422 7861
F +39 0422 786250

info@masierogroup.com
masierogroup.com

Design by Masiero
Photo, Studio Pointer
Styling NOOII
Print Italy, April 2021
by Grafica Antiga

Thanks to:
Paolo Utimpergher and
designer Franco Menna page 66

