



DRYLIGHT

MASIERO



DRYLIGHT

MASIERO

DRYLIGHT

design by Masiero Lab

Drylight è la magia della luce da esterni firmata Masiero.

Drylight è l'esclusiva linea brevettata Masiero che riproduce gli iconici lampadari veneziani per uso esterno.

Drylight is the magic of outdoor lighting signed by Masiero.

Drylight is an exclusive patented Masiero line reproducing the iconic Venetian chandelier for outdoor use.



DRYLIGHT

TECNOLOGIA DRYLIGHT
CON PROTEZIONE IP65:
SICUREZZA TOTALE IN OGNI
CONDIZIONE CLIMATICA.

DRYLIGHT è il cuore della tecnologia di questo affascinante progetto di stile. È frutto di anni di ricerca del reparto R&D Masiero che è riuscito a sviluppare una tecnologia che risponde in maniera efficiente e definitiva a tre problematiche che fino ad oggi sembravano insormontabili:

- Protezione contro la penetrazione dell'acqua e della polvere, resistente alla corrosione
- Resistenza alle sollecitazioni, al vento ed agli urti
- Leggerezza, modularità e semplicità di installazione

La tecnologia DRYLIGHT, brevetto industriale depositato, permette a MASIERO di offrire una linea completa di prodotti per l'illuminazione OUTDOOR con grado di protezione IP65.

Grazie a questa tecnologia è oggi possibile allestire qualsiasi ambiente all'aperto con lampadari in stile.

*DRYLIGHT TECHNOLOGY
WITH IP65 PROTECTION LEVEL:
COMPLETE SAFETY IN ANY
WEATHER CONDITIONS.*

DRYLIGHT is the heart of the technology behind this fascinating style project. It is the result of years of research carried out by Masiero's R&D department, which has succeeded in developing a technology that has effectively and definitively resolved three problems, which up to now appeared to be unsolvable:

- *Protection against water and dust, corrosion resistant*
- *Resistance to stress, wind and other impacts*
- *Lightness, modularity and easy installation*

DRYLIGHT technology, a filed industrial patent, permits MASIERO to offer a complete line of OUTDOOR lighting products with an IP65 protection level. Thanks to this technology, it is now possible to fit any outdoor environment with Venetian style chandeliers, with the same safety as a regular outdoor light.



CARATTERISTICHE/FEATURES



LINEA DRYLIGHT IP65
Totale protezione contro l'acqua.

LINE DRYLIGHT IP65
Total protection against water.



RESISTENTE AI RAGGI UV
Sviluppato con struttura in Policarbonato che non cristallizza o ingiallisce, testato per gli ambienti estremi.

UV RESISTANT
The structure is made of Polycarbonate, a material not subject to crystallization or yellowing, tested for extreme environments.



ILLUMINAZIONE A LUCE LED BIANCA OPPURE A LED RGB-W
Possibilità di ricreare infiniti scenari grazie alla tecnologia rgbw.

WHITE LED LIGHTING OR RGBW LED LIGHTING
Possibility to recreate countless scenario thanks to RGB-W technology.



RESISTENTE ALLE ALTE E BASSE TEMPERATURE
Testato in camera climatica con escursioni termiche ripetute da -30°C a +50°C.

RESISTANT TO HIGH AND LOW TEMPERATURES
Tested in climate chamber, with a temperature range from -30°C to +50°C.



VERSIONE RGB-W COMPATIBILE CON PROTOCOLLO DMX
Gestibile attraverso i più avanzati sistemi domotici.

RGB-W VERSION COMPATIBLE WITH DMX PROTOCOLS
Suitable for the most advanced home automation systems.



RESISTENTE ALL'UMIDITÀ, ALLA POLVERE ED ALLA CORROSIONE
Ideale per utilizzi in bagni, SPA e piscine. Testato in nebbia salina, ideale per aree costiere e utilizzi marittimi.

HUMIDITY, DUST AND CORROSION RESISTANT
Suitable for installation in baths, spas and swimming pools. Tested in saline fog, ideal for coastal areas and marine use.



SEMPLICITÀ DI INSTALLAZIONE E MANUTENZIONE

EASY INSTALLATION AND LOW MAINTENANCE



RESISTENTE ALLE SOLLECITAZIONI E AL VENTO
Testato in galleria del vento fino ad oltre 80 Km/h.
(Solo Versione Extreme)

RESISTANT TO STRESS AND WIND
*Tested in wind tunnel, with wind speeds higher than 80 Km/h.
(Extreme version only)*



PENDAGLI/PENDANTS

EXTREME



Pendagli e prismi
in policarbonato.

*Polycarbonate
pendants and prisms.*

PREMIUM



Pendagli e ottoni
in cristallo molato.
(Consigliato per uso interno)

*Cut crystal pendants and octagons
(Recommended for internal use only)*

LED WHITE



DRYLIGHT LED WHITE:

Singolo diodo led WHITE = 3000K, 280 Nominal lumen

DRYLIGHT LED WHITE:

Single diode led WHITE = 3000K, 280 Nominal lumen

LED RGB-W



DRYLIGHT LED RGBW:

Singolo diodo led Red = 60 Nominal lumen
Singolo diodo led Green = 180 Nominal lumen
Singolo diodo led Blue = 40 Nominal lumen
Singolo diodo led White = 140 Nominal lumen
Luce bianca Composita = 200 Nominal lumen

DRYLIGHT LED RGBW:

Single diode led Red = 60 Nominal lumen
Single diode led Green = 180 Nominal lumen
Single diode led Blue = 40 Nominal lumen
Single diode led White = 140 Nominal lumen
Composite white light = 200 Nominal lumen

DRYLIGHT incorpora un sistema LED RGB-W specificamente disegnato ed ingegnerizzato per rispondere in modo efficiente alle esigenze di affidabilità e robustezza. Non utilizza dunque componenti LED standard in commercio, o semplici lampadine commerciali, bensì una sofisticata soluzione brevettata. Composta da un dissipatore, una piastra LED a 4 diodi ed un gruppo ottico dedicati connessi ad una centralina elettronica, consente di realizzare infiniti scenari di intensità e colore della luce.

DRYLIGHT incorporates a LED RGB-W system specifically designed and engineered to efficiently meet the needs for reliability and strength. Consequently, standard LED components available on the market are not used, nor simple commercial bulbs, but a sophisticated patented system. It comprises a dissipater, a 4 diode LED plate and an optic unit that is connected to an electronic control unit, to create endless combinations of light intensity and colour.

RGB-W CONTROL

RGB-W

Il sistema **RGB-W Control** è dotato di una centralina* di controllo che consente di gestire tutte le funzioni in base alle esigenze dell'utilizzatore.

The control unit in the **RGB-W Control** system allows all functions to be managed according to the user's needs.*

Ogni dispositivo **Drylight RGB-W** può essere integrato nei sistemi domotici di qualsiasi abitazione gestiti con **protocollo DMX**.

*Each **Drylight RGB-W** device can be integrated into any home automation system managed with the **DMX protocol**.*

Su richiesta è possibile fornire il dispositivo di uno di questi sistemi di gestione:

On request, the device can be provided with one of the following control systems:

- **RADIOCOMANDO:**
Ogni singolo dispositivo può essere controllato con un radiocomando.
Su richiesta, un unico radiocomando può gestire più dispositivi diversi.
- **APP SU SMARTPHONE O TABLET:**
MASIERO ha sviluppato una **APP** disponibile per **systemi IOS** e **Android** che, con un'interfaccia semplice ed intuitiva, permette di gestire un numero infinito di dispositivi, contemporaneamente oppure singolarmente.

- **RADIO CONTROL:**
Each individual device can be controlled via a radio remote control.
On request, a single remote control can manage several different devices.
- **APP ON YOUR SMARTPHONE OR TABLET:**
*MASIERO has developed an **APP** for **IOS** and **Android** systems with a simple, intuitive interface to allow an infinite number of devices to be controlled together or individually.*

RADIO CONNECTION WITH REMOTE CONTROL

WI-FI CONNECTION WITH "MASIERO SMART LIGHT" APP

DMX CONNECTION WITH DOMOTIC NET



*Centralina non inclusa
Control unit not included



MASIERO SMART LIGHT APP



CON LA APP MASIERO SMART LIGHT SI POSSONO GESTIRE UN NUMERO INFINITO DI DISPOSITIVI, TRAMITE IL SISTEMA HOST-SLAVE.

WITH THE MASIERO SMART LIGHT APP, AN INFINITE NUMBER OF A PPLIANCES CAN BE CONTROLLED THROUGH THE HOST-SLAVE SYSTEM.

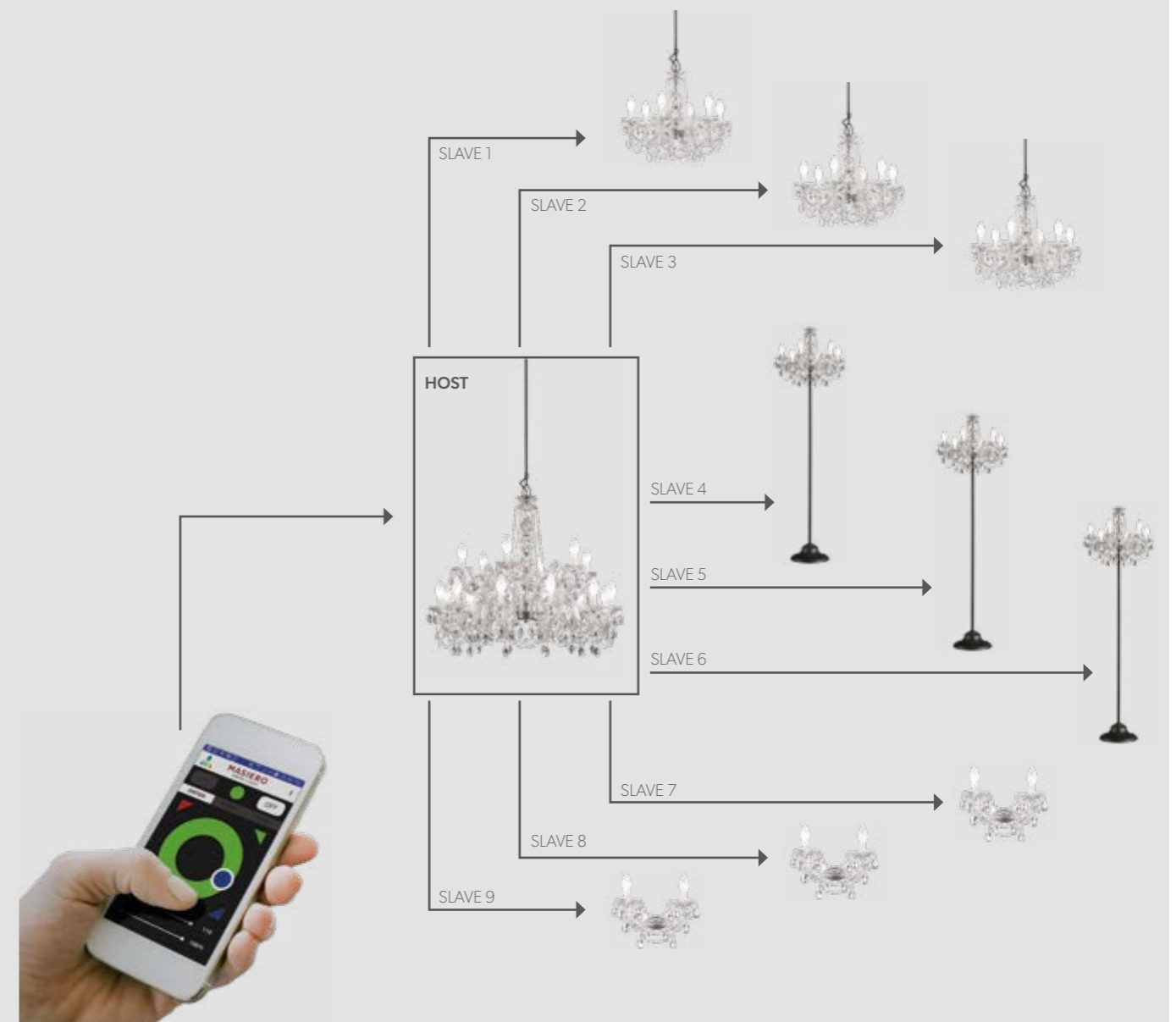

Indice/Index



DRYLIGHT S6
16



DRYLIGHT S12
26



DRYLIGHT S18
34



DRYLIGHT S24
50



DRYLIGHT TL6
54



DRYLIGHT STL6
64



DRYLIGHT A2
78

DRYLIGHT S6

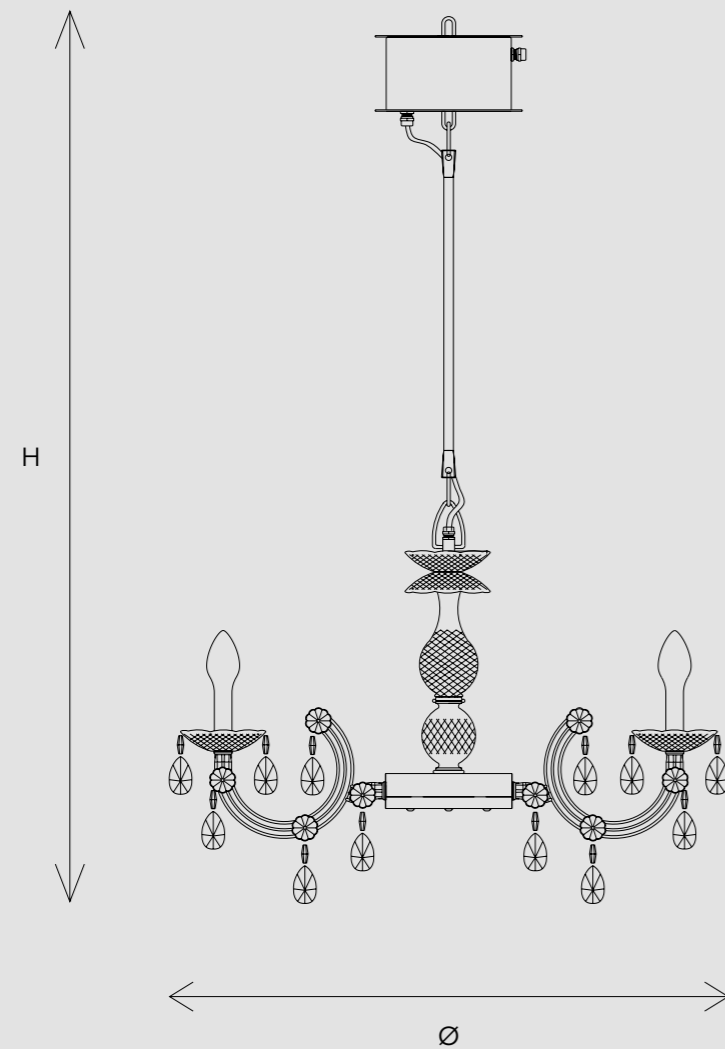

CE  IP65

Ø	75 cm / 29.52"
H	125 cm / 49.21"
W EXTREME	7,3 kg / 16.09 lb
W PREMIUM	8,7 kg / 19.18 lb
H ROD 45	45 cm / 17.71"
H ROD 35 (on request)	35 cm / 13.77"
H ROD 25 (on request)	25 cm / 9.84"

LED WHITE 6×LED source – 3000 K – 18 W tot – 1680 Nominal lumen (driver included) Not Dimmable

LED RGB-W 6×LED source – 24 W tot (driver included) Dimmable





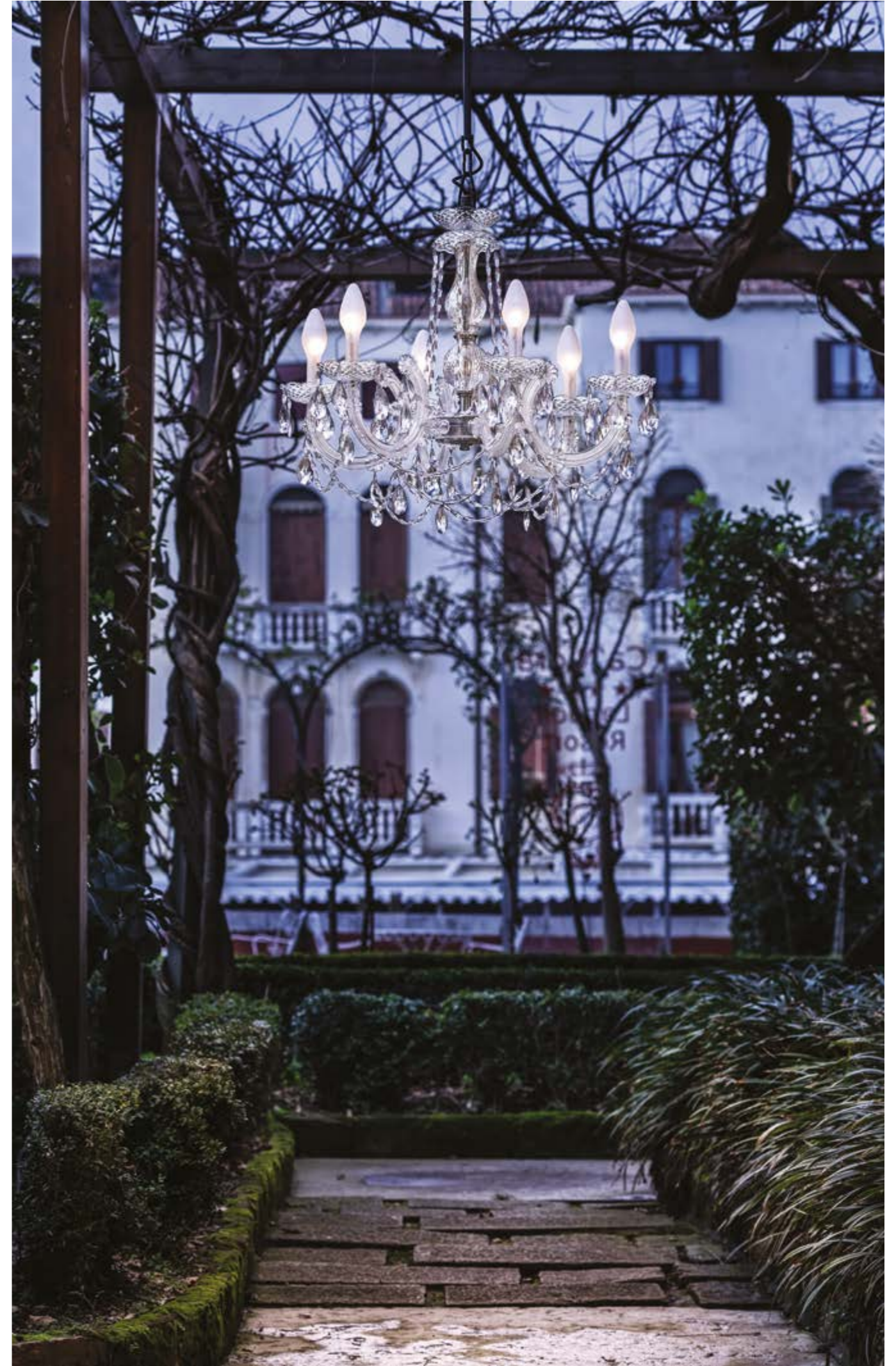





DRYLIGHT S12

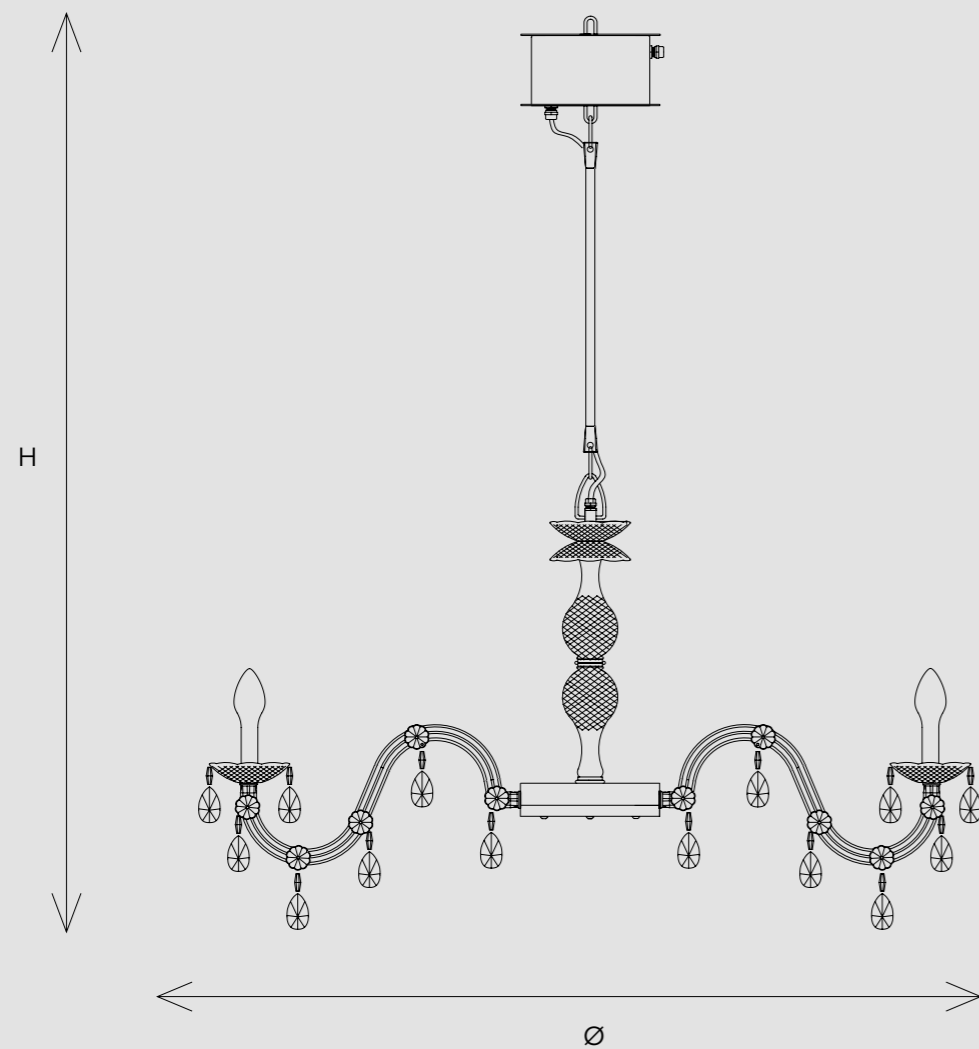

CE  IP65

Ø	113 cm / 44.48"
H	135 cm / 53.15"
W EXTREME	10,6 kg / 23.36 lb
W PREMIUM	13,4 kg / 29.54 lb
H ROD 45	45 cm / 17.71"
H ROD 35 (on request)	35 cm / 13.77"
H ROD 25 (on request)	25 cm / 9.84"

LED WHITE 12×LED source – 3000 K – 36 W tot – 3360 Nominal lumen (driver included) Dimmable TRIAC

LED RGB-W 12×LED source – 48 W tot (driver included) Dimmable









DRYLIGHT S18

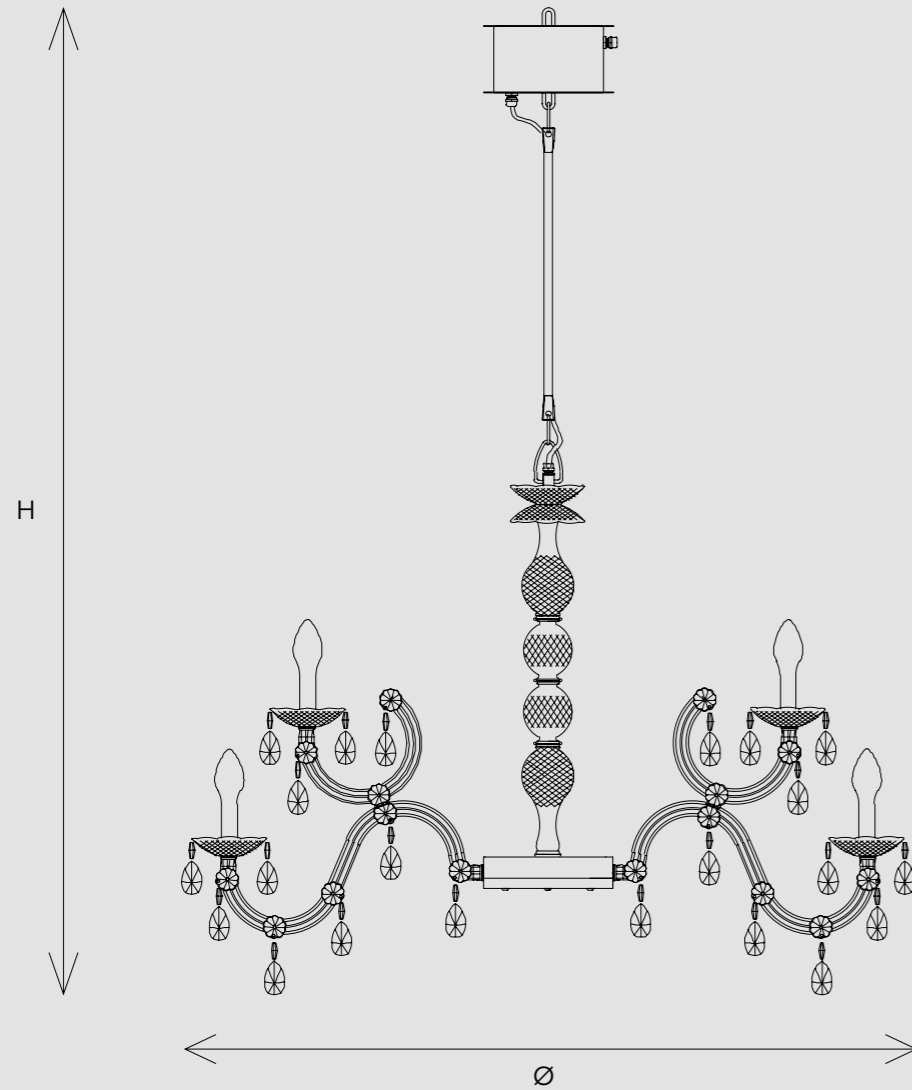

CE IP65

DRYLIGHT S18 WHITE

Ø	113 cm / 44.48"
H	150 cm / 59.05"
W EXTREME	16,1 kg / 35.49 lb
W PREMIUM	20,2 kg / 44.53 lb
H ROD 45	45 cm / 17.71"
H ROD 35 (on request)	35 cm / 13.77"
H ROD 25 (on request)	25 cm / 9.84"

LED WHITE 18xLED source – 3000 K – 54 W tot – 5040 Nominal lumen (driver included)
Dimmable TRIAC

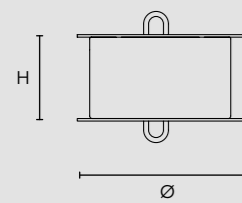

Ø	20 cm / 7.87"
H	10 cm / 3.94"

CE IP65

DRYLIGHT S18 RGB-W

Ø	113 cm / 44.48"
H	154 cm / 60.62"
W EXTREME	16,1 kg / 35.49 lb
W PREMIUM	20,2 kg / 44.53 lb
H ROD 45	45 cm / 17.71"
H ROD 35 (on request)	35 cm / 13.77"
H ROD 25 (on request)	25 cm / 9.84"

LED RGB-W 18xLED source – 72 W tot (driver included)
Dimmable

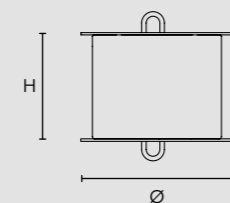

Ø	20 cm / 7.87"
H	14 cm / 5.51"

















DRYLIGHT S24

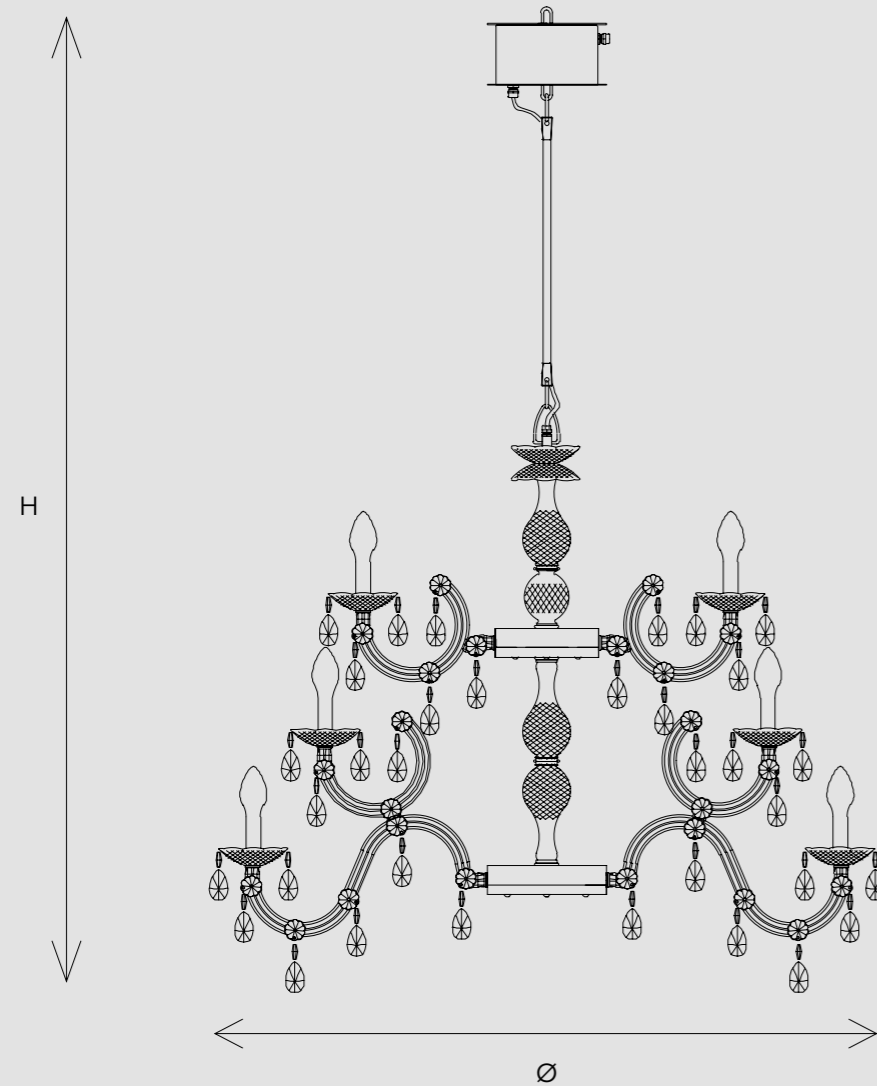

CE  IP65

DRYLIGHT S24 WHITE

Ø	113 cm / 44.48"
H	165 cm / 64.96"
W EXTREME	23,5 kg / 51.80 lb
W PREMIUM	29,7 kg / 65.47 lb
H ROD 45	45 cm / 17.71"
H ROD 35 (on request)	35 cm / 13.77"
H ROD 25 (on request)	25 cm / 9.84"

LED WHITE 24xLED source – 3000 K – 72 W tot –
6720 Nominal lumen (driver included)
Dimmable TRIAC

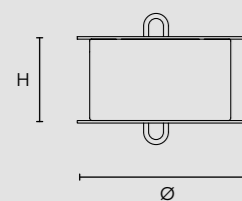

Ø	20 cm / 7.87"
H	10 cm / 3.94"

CE  IP65

DRYLIGHT S24 RGB-W

Ø	113 cm / 44.48"
H	169 cm / 66.53"
W EXTREME	23,5 kg / 51.80 lb
W PREMIUM	29,7 kg / 65.47 lb
H ROD 45	45 cm / 17.71"
H ROD 35 (on request)	35 cm / 13.77"
H ROD 25 (on request)	25 cm / 9.84"

LED RGB-W 24xLED source – 96 W tot (driver included)
Dimmable

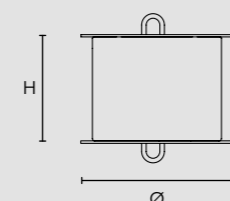

Ø	20 cm / 7.87"
H	14 cm / 5.51"





DRYLIGHT TL6

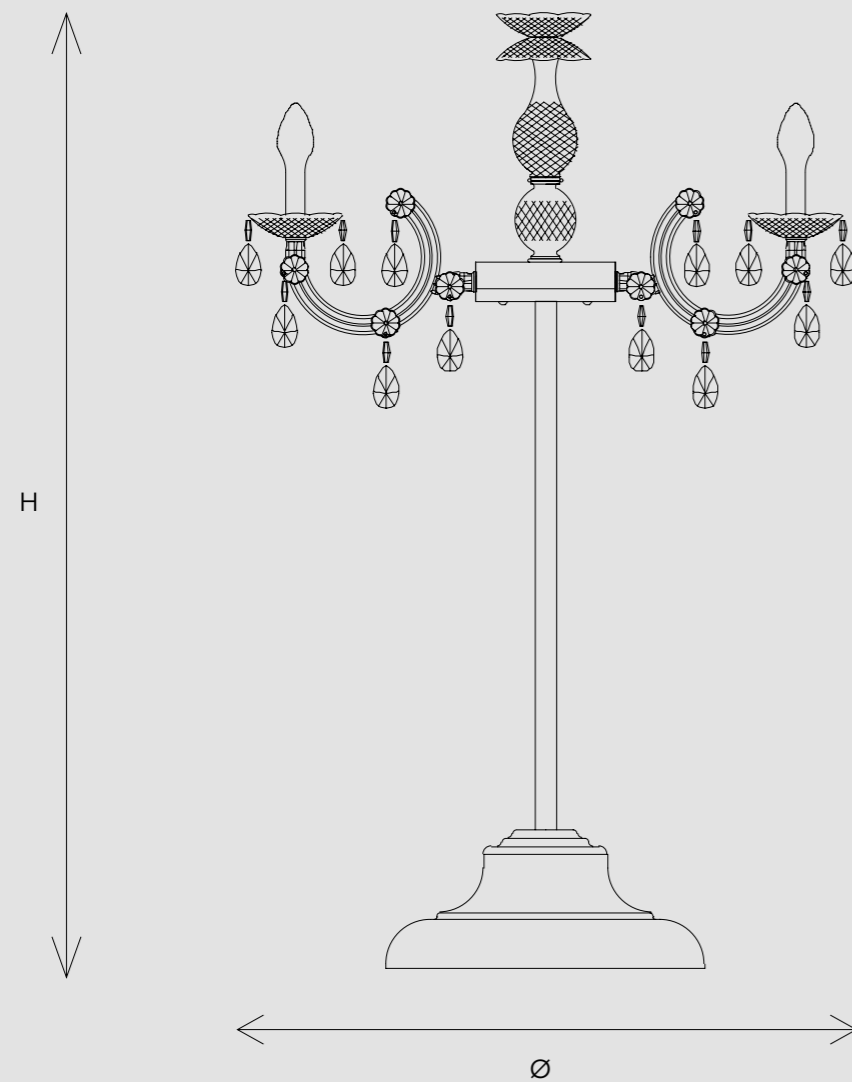

CE IP65

Ø 75 cm / 29.52"
H 120 cm / 47.24"

LED WHITE 6×LED source – 3000 K – 18 W tot – 1680 Nominal lumen (driver included) Not Dimmable

LED RGB-W 6×LED source – 24 W tot (driver included) Dimmable

ALIMENTAZIONE A BATTERIA OPZIONALE
AUTONOMIA 10 ORE
TEMPO DI RICARICA 5 ORE

OPTIONAL BATTERY POWERED
10 HOURS AUTONOMY
5 HOURS TO RECHARGE

VERSIONE RGB-W

Le piantane integrano sia un'antenna Wi-Fi che un ingresso per cavo DMX.
In questo modo, luce e scenari luminosi possono essere gestiti mediante la APP su smartphone o tablet, oppure attraverso la centralina elettronica di controllo di un qualsiasi sistema domotico con protocollo DMX.

RGB-W VERSION

The floor lamps integrate a Wi-Fi antenna and a DMX lead input.
This way light and lighting effects can be controlled from the APP on a smartphone or tablet, or from the electronic control unit of any home automation system equipped with DMX protocol.











DRYLIGHT STL6

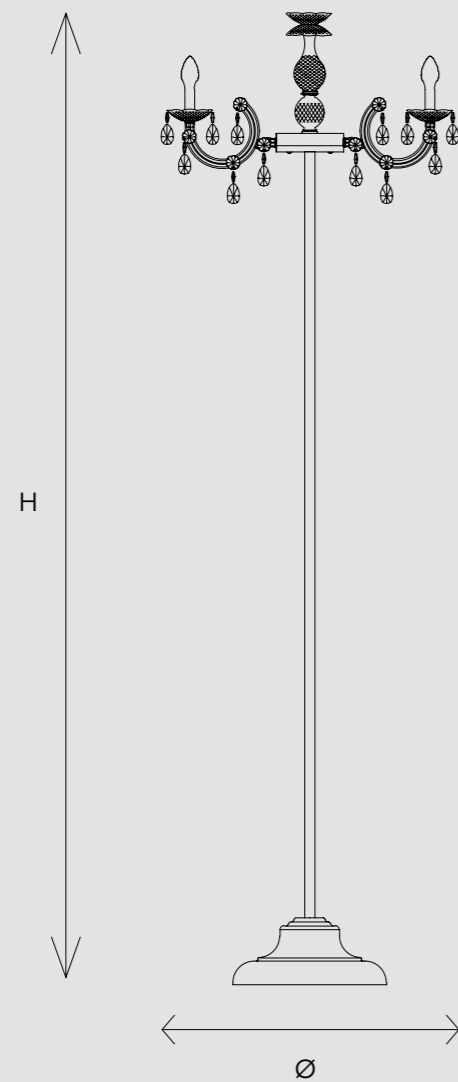

CE IP65

Ø 75 cm / 29.52"
H 245 cm / 96.45"

LED WHITE 6×LED source – 3000 K – 18 W tot – 1680 Nominal lumen (driver included) Not Dimmable

LED RGB-W 6×LED source – 24 W tot (driver included) Dimmable

ALIMENTAZIONE A BATTERIA OPZIONALE
AUTONOMIA 10 ORE
TEMPO DI RICARICA 5 ORE

OPTIONAL BATTERY POWERED
10 HOURS AUTONOMY
5 HOURS TO RECHARGE

VERSIONE RGB-W

Le piantane integrano sia un'antenna Wi-Fi che un ingresso per cavo DMX.
In questo modo, luce e scenari luminosi possono essere gestiti mediante la APP su smartphone o tablet, oppure attraverso la centralina elettronica di controllo di un qualsiasi sistema domotico con protocollo DMX.

RGB-W VERSION

The floor lamps integrate a Wi-Fi antenna and a DMX lead input.
This way light and lighting effects can be controlled from the APP on a smartphone or tablet, or from the electronic control unit of any home automation system equipped with DMX protocol.















DRYLIGHT A2

WHITE VERSION

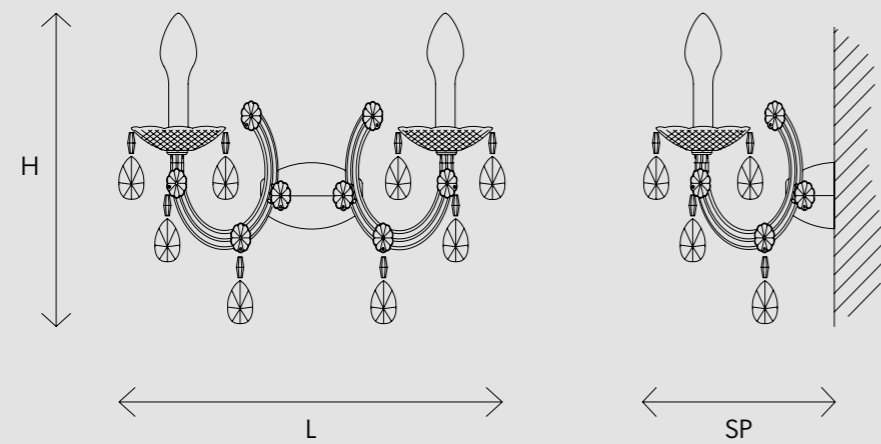

CE IP65

L	44 cm / 17.32"
SP	30 cm / 11.81"
H	37 cm / 14.56"

LED WHITE 2xLED source - 3000 K - 6 W tot - 560 Nominal lumen (driver included) Not Dimmable

RGB-W VERSION

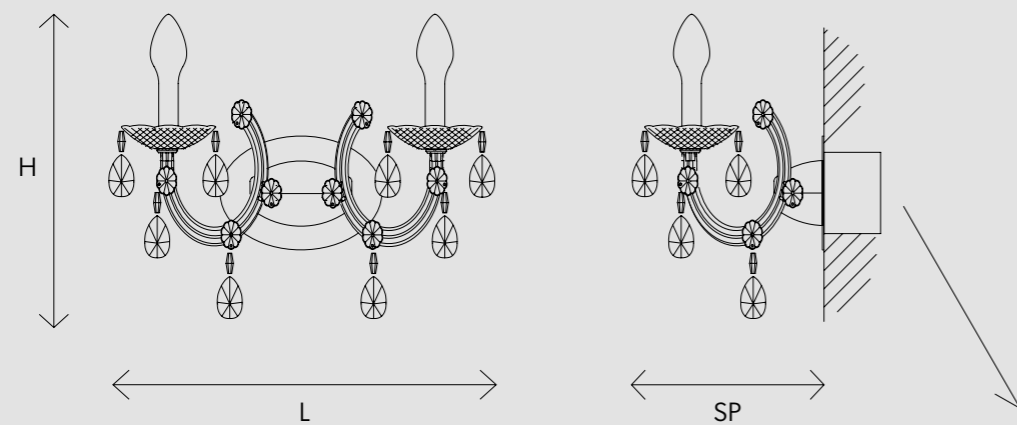

SCATOLA A INCASSO (Non inclusa)
FLUSH-MOUNTED BOX (Not included)

L	10 cm / 3.93"
SP	7 cm / 2.75"
H	10 cm / 3.93"

CE IP65

L	44 cm / 17.32"
SP	30 cm / 11.81"
H	37 cm / 14.56"

LED RGB-W 2xLED source - 8 W tot (driver included) Dimmable



DRYLIGHT SUPPORT

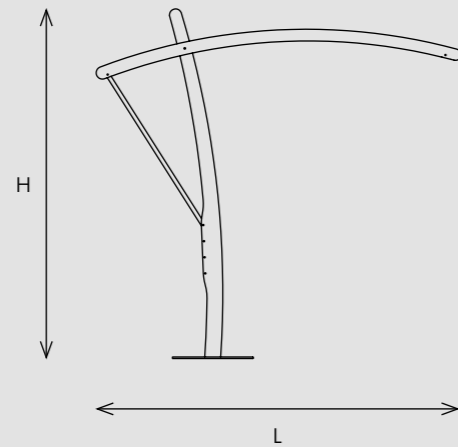

ALTEZZE RAGGIUNGIBILI
AVAILABLE HEIGHTS

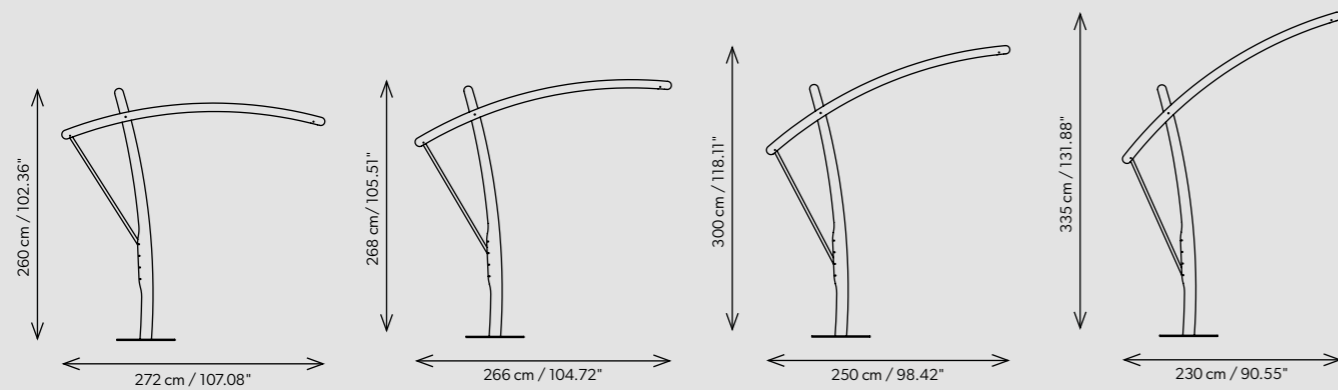

L 230 cm - 272 cm / 90.55" - 107.08"
H 335 cm - 260 cm / 131.88" - 102.36"

Struttura in metallo zincato e verniciato con altezza regolabile.

Base predisposta per il fissaggio a terra.

Base a croce 130 cm x 130 cm per piastre quadrate in materiale cementizio.

Si consiglia di installare 4 piastre quadrate 60 cm x 60 cm con peso di 33 kg ciascuno. (Non include)

Zin-coated and painted metal structure with adjustable height.

Base geared for fixing to the ground.

Base 51.18" x 51.18" with cross brackets for square concrete slabs.

We suggest to fix 4 square slabs 23.62" x 23.62", 33 Kg each. (Not included)



(Piastrre quadrate non incluse)
(Square slabs not included)

CE

Attesta la conformità del prodotto alle disposizioni delle Direttive comunitarie.

It certifies the conformity of the products to the European Community provisions.

Il atteste la conformité du produit aux dispositions des directives communaitaires.

Konformität des Produktes mit den Richtlinien der europäischen Gemeinschaft.

НАСТОЯЩИМ ПОДТВЕРЖДАЕТСЯ СООТВЕТСТВИЕ ПРОДУКЦИИ ПОЛОЖЕНИЯМ ДИРЕКТИВ ЕС.

Certifica la conformidad del producto según las disposiciones de las directivas comunitarias.

CE标记是指产品的制造商证明该产品符合适用的EC指令的所有基本要求。

يُشهد بمطابقة المنتج لأحكام توجيهات المجتمع الأوروبي.



Il logo "ETL" si riferisce agli articoli che possono essere modificati con componenti certificati ETL. L'elenco degli articoli ETL si riferisce a prodotti testati e valutati in base agli standard di sicurezza del mercato statunitense. Per il mercato USA fare riferimento al listino dedicato.

"ETL" logos refers to articles which can be modified with ETL- compliance components. The "ETL" listing articles stands for tested and evaluated product to recognised US safety standards. For the US market, refer to the relevant price list.

"ETL" logo se réfère aux articles qui peuvent être modifiées par des composants certifiés ETL. la liste des articles ETL se réfère à des produits testés et évalués selon les normes de sécurité du marché américain. Pour le marché américain se référer à la liste des prix.

Das "ETL"-Logo bezieht sich auf Artikel, die mit ETL-zertifizierten Komponenten modifiziert werden können. Die Liste der ETL-Artikel bezieht sich auf Produkte, die nach den Sicherheitsstandards des US-Marktes getestet und bewertet wurden. Für den US-Markt beachten Sie bitte die entsprechende Preisliste.

ЛОГОТИП «ETL» ОТНОСИТСЯ К ЭЛЕМЕНТАМ, КОТОРЫЕ МОГУТ БЫТЬ МОДИФИЦИРОВАННЫ С ПОМОЩЬЮ СЕРТИФИЦИРОВАННЫХ ETL КОМПОНЕНТОВ. СПИСОК ЭЛЕМЕНТОВ ETL ОТНОСИТСЯ К ПРОДУКЦИИ, ПРОТЕСТИРОВАННОЙ И ОЦЕНЕННОЙ В СООТВЕТСТВИИ С ПРИЗНАННЫМИ СТАНДАРТАМИ БЕЗОПАСНОСТИ США. ДЛЯ ПОТРЕБИТЕЛЕЙ НАХОДЯЩИХСЯ В США СМ. СООТВЕТСТВУЮЩИЙ ПРАЙС-ЛИСТ.

El logo "ETL" indica los artículos, que pueden modificarse con componentes certificados ETL. La lista de los artículos ETL se refiere a los productos sometidos a prueba y evaluados en función de los estándares de seguridad del mercado estadounidense. Consultar la lista de precios específica para el mercado de los Estados Unidos.

"ETL" 徽标是指可以使用ETL认证的组件进行修改的项目。 ETL项目列表是指根据美国市场的安全标准进行测试和评估的产品。 对于美国市场, 请参考美国市场价格表。

يشير شعار «ETL» إلى المنتجات التي يمكن تعديلها باستخدام مكونات مُعتمدة من ETL. تشير قائمة منتجات ETL إلى المنتجات التي تم اختبارها وتقييمها وفقًا لمعايير السلامة في السوق الأمريكي. بالنسبة لسوق الولايات المتحدة الأمريكية، يُرجى الرجوع إلى قائمة الأسعار المُخصصة.

Im

Flusso luminoso nominale. L'indicazione si riferisce al valore in assenza di rifrazione, come dichiarato dal produttore del componente.

Nominal luminous flux. It refers to the value without any refraction, as declared by the component manufacturer.

L'unité SI de flux lumineux. L'indication correspond à la valeur en l'absence de réfraction, comme indiqué par le fabricant du composant.

Die Maßeinheit für den Lichtstrom. Die Angabe bezieht sich auf den Wert in der Abwesenheit von Brechung, wie vom Hersteller der Komponente angegeben.

НОМИНАЛЬНЫЙ СВЕТОВОЙ ПОТОК. УКАЗАНИЕ ОТНОСИТСЯ К ЗНАЧЕНИЮ В ОТСУТСТВИЕ РЕФРАКЦИИ, КАК ЗАЯВЛЕНО ПРОИЗВОДИТЕЛЕМ КОМПОНЕНТОВ.

Flujo luminoso nominal. La indicación se refiere al valor sin refracción, como declarado por el fabricante del componente.

标称光通量。指示是指组件制造商声明的没有折射的值。 التدفق الضوئي الاسمي. يشير المؤشر إلى القيمة في حالة عدم وجود انكسار للضوء، كما هو مُعلن من قبل الشركة المصنعة للعنصر.

MASIERO

Masiero si riserva il diritto di apportare ai propri articoli, senza nessun preavviso, qualsiasi modifica ritenesse opportuna.

Masiero reserves the right to introduce any changes to its own products, without notice in advance.

Masiero se réserve le droit d'apporter une quelconque modification à les modèles sans préavis.

Masiero behalt sich das Recht vor änderungen vorzunehmen, ohne sofortige Benachrichtigung.

КОМПАНИЯ MASIERO ОСТАВЛЯЕТ ЗА СОБОЙ ПРАВО БЕЗ ПРЕДВАРИТЕЛЬНОГО УВЕДОМЛЕНИЯ, ЕСЛИ ЭТО БУДЕТ СОЧЕНО ЦЕЛЕСОБРАЗНЫМ, ВНОСИТЬ В СОБСТВЕННЫЕ МОДЕЛИ ЛЮБЫЕ ИЗМЕНЕНИЯ.

Masiero se reserva el derecho de aportar modificaciones consideradas oportunas a sus artículos sin preaviso.

Masiero 保留对其认为适当的任何更改的权利, 恕不另行通知。

تحتفظ شركة مازيرو "Masiero" بالحق في إجراء أي تعديلات تراها مناسبة على منتجاتها، دون إشعار مسبق.

Masiero srl

via Peschiere, 53
31032 Casale sul Sile
Treviso, Italy
T +39 0422 7861
F +39 0422 786250

info@masierogroup.com
masierogroup.com

Design by Masiero
Photo, Studio Pointer
Print Italy, May 2021
by Grafica Antiga



UNI EN ISO 9001:2015
UNI EN ISO 14001:2015

[masierogroup.com](https://www.masierogroup.com)